

King Fahd University of Petroleum & Minerals Computer Engineering Dept

COE 241 – Data and Computer
Communications

Term 141

Dr. Ashraf S. Hasan Mahmoud

Rm 22-420

Ext. 1724

Email: ashraf@kfupm.edu.sa

8/31/2014

Dr. Ashraf S. Hasan Mahmoud

1

Lecture Contents

1. OSI
 - a. The model
 - b. OSI layers
2. TCP/IP Protocol Suite
3. Multimedia and Types of Traffic

8/31/2014

Dr. Ashraf S. Hasan Mahmoud

2

The OSI Model

- Software model and abstraction
- Defines set of layers and the services at these layers necessary to perform communication
- Promotes compatibility of network designs
- Logical partitioning:
 - Manageability and scalability

8/31/2014

Dr. Ashraf S. Hasan Mahmoud

3

The OSI Model – Example:

- Source: http://en.wikipedia.org/wiki/OSI_model

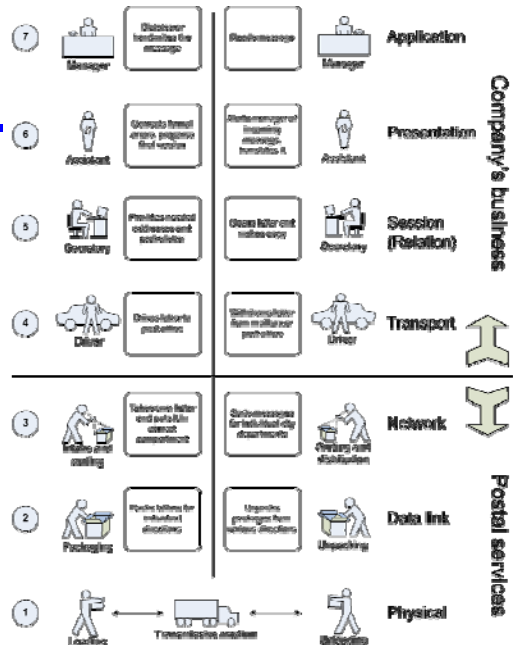

8/31/2014

Dr. Ashraf

RM – OSI and letter communication parallel

The OSI Model - Environment

- Layer *i* establishes a PEER relationship with layer *i* on the target node
- This means Layer *i* requires service from layer *i*-1
- And so on
- The use of the PDUs
- No direct communication except for the physical layer – all other communication is indirect or virtual
- Encapsulation of user data
- Each layer may segment SDU to accommodate its own requirement – These are reassembled at the other end

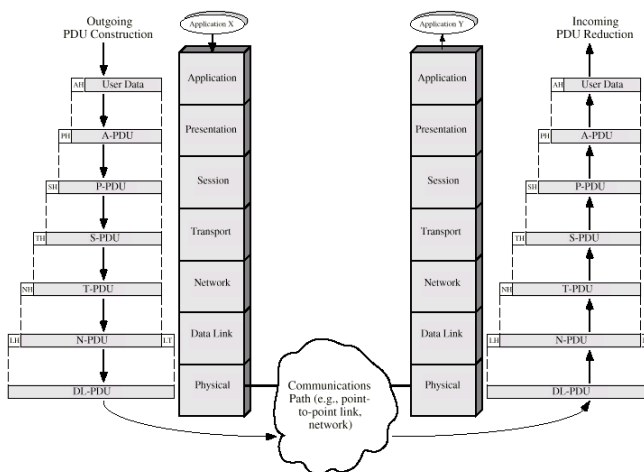

8/31/2014

Dr. Ashraf S. Hasan Mahmoud

5

The OSI Model - Framework

- Very similar to subroutine or function design in software engineering
- Boundaries and functionalities are well designed – development of one layer has little or no effect on other layers
- Protocol specification:
 - Format of PDUs, and the semantic of each field
- Service definition:
 - What are the services provided to upper layer and the lower one
- Addressing:
 - E.g: NSAP is the address of an entity in the transport layer who uses the network service

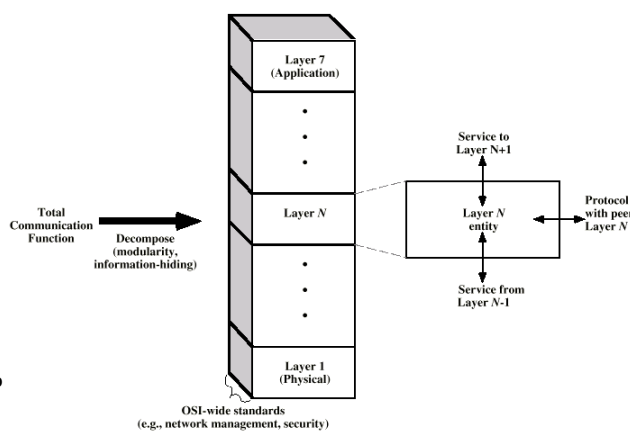

8/31/2014

Dr. Ashraf S. Hasan Mahmoud

6

The OSI Model - Framework

- Service Primitives:

- Request:
- Indication:
- Respond
- Confirm

- Note:

- Encapsulation
- Peer communication is virtual (dashed lines) – except at physical layer

- Figure shows confirmed services case – For non confirmed services, the initiator receives no confirmation.

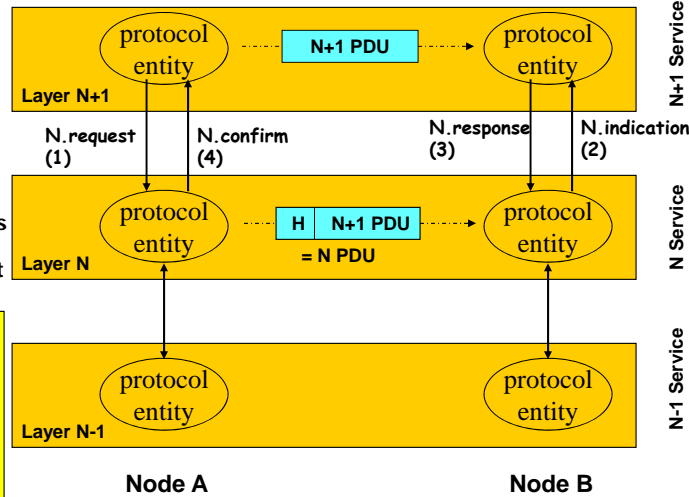

8/31/2014

Dr. Ashraf S. Hasan Mahmoud

7

The OSI Model – Physical Layer

- Specifications:

- Mechanical: dimensions, connectors, etc.
- Electrical: signal levels, rates of change, etc
- Functional: functions performed by each circuit
- Procedural: steps required to transport bits from one end to the other
- Provides service to do “transmission of raw bits”

8/31/2014

Dr. Ashraf S. Hasan Mahmoud

8

The OSI Model – Data Link Layer

- **Converts the raw bit stream service provided by the physical layer to a reliable stream:**
 - Performs error detection and error control
- **Examples: HDLC, LAPB, LLC, etc**

8/31/2014

Dr. Ashraf S. Hasan Mahmoud

9

The OSI Model – Network Layer

- **Service: transfer of information between two end systems across communication network – End to end delivery of packets**

- Two end systems may be connected by:
 - Point-2-point: no need for network layer
 - Same network (see figure)
 - Different network

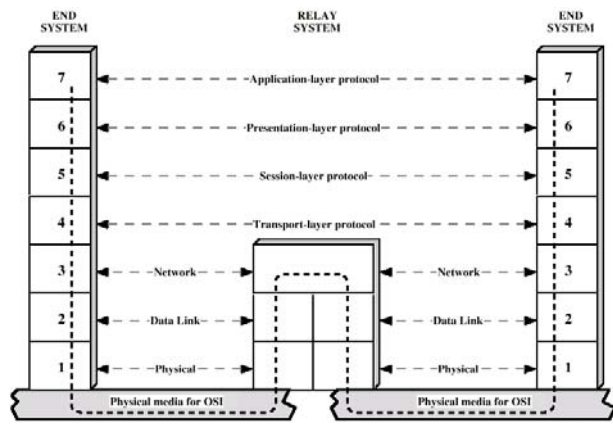

8/31/2014

The OSI Model – Transport Layer

- **Service: mechanism of exchanging data (or messages) between the two end systems:**
 - For connection oriented networks:
 - Error-free delivery
 - Ordered delivery
 - No loss or duplication
 - Attempts to provide a certain quality of service (QoS) {certain max error rate, delay jitter, etc) through optimizing the the network layer services
- **Example: TCP (connection oriented), UDP (connectionless)**

8/31/2014

Dr. Ashraf S. Hasan Mahmoud

11

The OSI Model – Session Layer

- **Service: mechanism of controlling the dialogue between applications at end systems**
 - Dialogue Discipline
 - Grouping
 - Recovery

8/31/2014

Dr. Ashraf S. Hasan Mahmoud

12

The OSI Model – Presentation

- **Service: defines format of data (format, encryption, and compression) to be exchanged between applications**

The OSI Model – Application

- **Service: A means for user applications (email, ftp, etc) to access the services provided by the OSI model**

The TCP/IP Model

- **TCP/IP is the result of R&D conducted on experimental packet switched network (ARPANET) and funded by Defense Advanced Research Agency (DARPA)**
- **TCP/IP is NOW the dominant commercial architecture – The foundation of the internet and its applications**

8/31/2014

Dr. Ashraf S. Hasan Mahmoud

15

The TCP/IP Model

- **Model has five independent layers:**
 - **Application layer: comm between processes or applications on separate hosts**
 - **Transport layer: end-2-end transfer service – may include reliability mechanisms**
 - **Internet layer: routing data from source to destination through one or more networks**
 - **Network access layer: logical interface between end systems and the network**
 - **Physical layer: defines mechanism of transmitting raw bits depending on media characteristic**

8/31/2014

Dr. Ashraf S. Hasan Mahmoud

16

The TCP/IP Model (using the OSI Model as a reference)

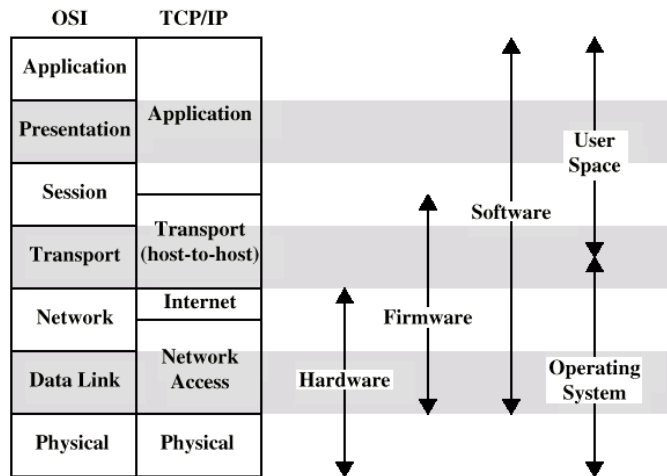

8/31/2014

Dr. Ashraf S. Hasan Mahmoud

17

Example of TCP/IP Communications

- A process (has port 1) on host A needs to communicate to another process: port 2 at host B
- The application layer on A hands the msg down to TCP with instructions to deliver it to (port2,host B)
- TCP hands msg down to IP with instructions to send it to host B:
 - The IP layer knows how to reach host B (or at least the first hop of the route) – does not care about port info
- IP hands down packets to network access (say Ethernet) with instructions to pass it to next router (first hop on the way to B)

8/31/2014

Dr. Ashraf S. Hasan Mahmoud

18

Example of TCP/IP Communications

- Does not show segmentation (or fragmentation in IP terms) process!

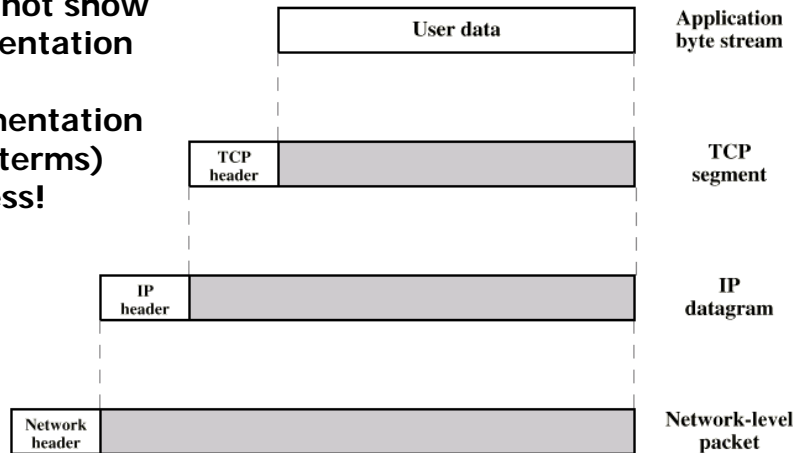

8/31/2014

Dr. Ashraf S. Hasan Mahmoud

19

TCP Headers

- TCP control info:
 - Destination port number
 - Sequence number
 - Checksum

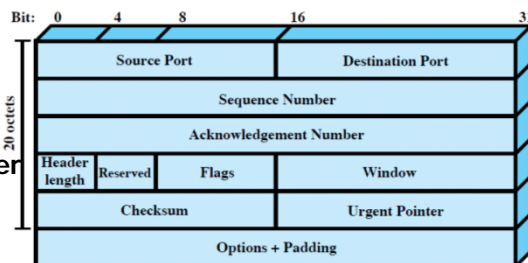

(a) TCP Header

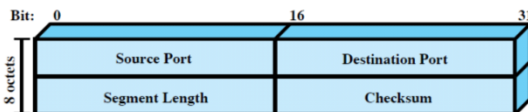

(b) UDP Header

8/31/2014

Dr. Ashraf S. Hasan Mahmoud

20

Figure 2.3 TCP and UDP Headers

IP Header

- **IP control Info**
 - Version
 - Source Address
 - Destination Address
 - Protocol
- Note the 32-bit address for IPv4 versus the 128-bit address for IPv6.

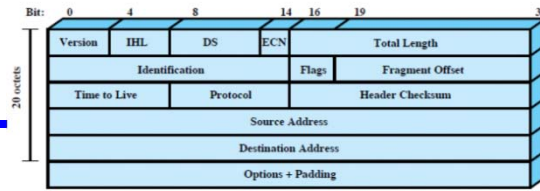

(a) IPv4 Header

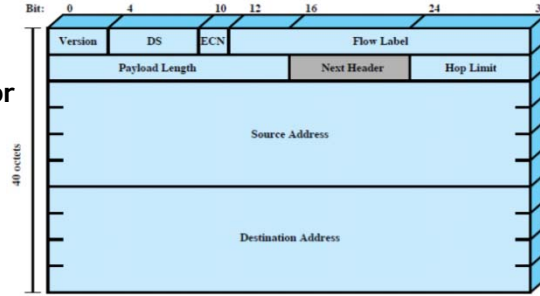

(b) IPv6 Header

DS = Differentiated services field
 ECN = Explicit congestion notification field

Note: The 8-bit DS/ECN fields were formerly known as the Type of Service field in the IPv4 header and the Traffic Class field in the IPv6 header.

Figure 2.4 IP Headers

TCP/IP Protocols

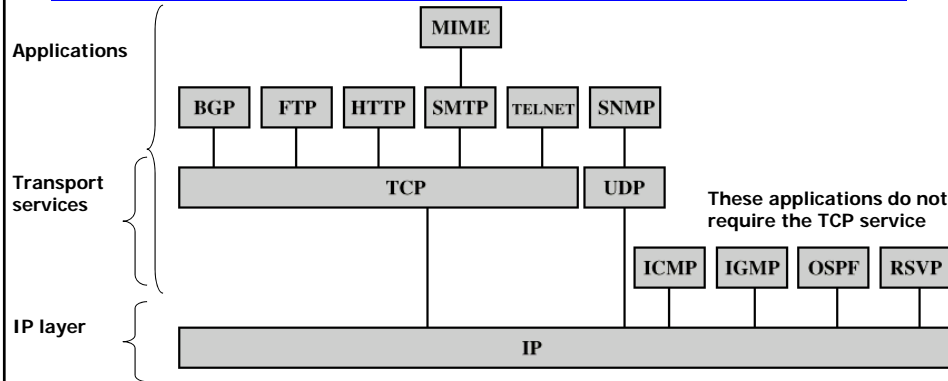

BGP = Border Gateway Protocol
 FTP = File Transfer Protocol
 HTTP = Hypertext Transfer Protocol
 ICMP = Internet Control Message Protocol
 IGMP = Internet Group Management Protocol
 IP = Internet Protocol
 MIME = Multi-Purpose Internet Mail Extension

OSPF = Open Shortest Path First
 RSVP = Resource ReSerVation Protocol
 SMTP = Simple Mail Transfer Protocol
 SNMP = Simple Network Management Protocol
 TCP = Transmission Control Protocol
 UDP = User Datagram Protocol

Typical Internet Applications

- **Simple Mail Transfer Protocol (SMTP)**
- **File Transfer Protocol (FTP)**
- **Telnet**

8/31/2014

Dr. Ashraf S. Hasan Mahmoud

23

Multimedia

- **Media: text, still images, and video**
- **Multimedia: Human-computer interaction involving text, graphics, images, and/or audio/video**
- **Streaming Media: video and audio clips**
- **Quality of Service (QoS) Parameters include:**
 - Throughput, delay, delay variation (jitter), packet loss, etc.
- **Types of Traffic:**
 - Elastic: can accept variable range of QoS levels across the internet – e.g. TCP/IP is designed for this
 - Inelastic – have very strict QoS levels requirements – e.g. (real-time) voice traffic

8/31/2014

Dr. Ashraf S. Hasan Mahmoud

24