

# King Fahd University of Petroleum & Minerals Computer Engineering Dept

---

COE 341 – Data and Computer  
Communications

Term 112

Dr. Ashraf S. Hasan Mahmoud

Rm 22-420

Ext. 1724

Email: [ashraf@kfupm.edu.sa](mailto:ashraf@kfupm.edu.sa)

3/12/2012

Dr. Ashraf S. Hasan Mahmoud

1

## Lecture Contents

---

1. Background
2. Digital Data, Digital Signals
3. Digital Data, Analog Signals
4. Analog Data, Digital Signals
5. Analog Data, Analog Signals

3/12/2012

Dr. Ashraf S. Hasan Mahmoud

2

## Background

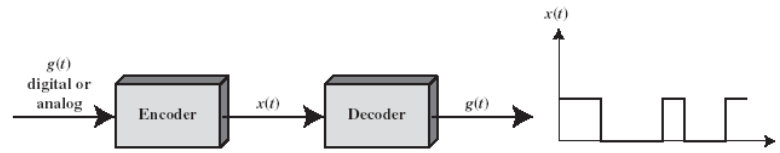

(a) Encoding onto a digital signal

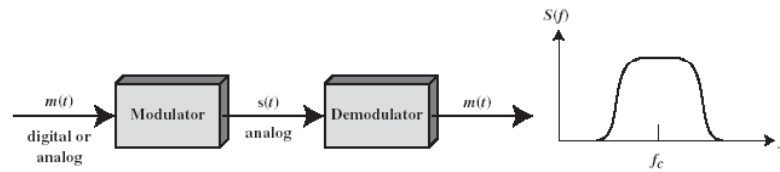

(b) Modulation onto an analog signal

3/12/2012

Dr. Ashraf S. Hasan Mahmoud

3

## Background - Digital Signaling

- **Data source  $g(t)$** 
  - Analog source – voice
  - Digital source – computer data (file)
- **ENCODED** – to match medium characteristics and optimize transmission – Result is  $x(t)$
- Note that  $x(t)$  is digital (discrete voltage levels)

3/12/2012

Dr. Ashraf S. Hasan Mahmoud

4

## Background – Analog Signaling

- **Data source  $m(t)$** 
  - Analog source – voice
  - Digital source – computer data (file)
- **MODULATED:**
  - We need a carrier signal: continuous-time constant frequency signal ( $f_c$ ) {i.e.  $A \cos(2\pi f_c t + \phi)$  or  $A \sin(2\pi f_c t + \phi)$ }
  - Frequency of carrier is chosen to match transmission characteristic of medium
  - Modulation: Encoding source data onto carrier:
    - Manipulating frequency – phase – Amplitude – or a combination of these elements
  - Process of encoding is chosen to optimize transmission

3/12/2012

Dr. Ashraf S. Hasan Mahmoud

5

## Background – Analog Signaling (2)

- Note that  $s(t)$  is analog (continuous voltage levels)
- Bandwidth of  $s(t)$  is usually centered around  $f_c$
- $s(t)$  is a *bandlimited* or *bandpass* signal:
  - Finite bandwidth at or around  $f_c$

3/12/2012

Dr. Ashraf S. Hasan Mahmoud

6

## Background – Baseband vs. Bandpass Signals

- **Baseband Signal:**
  - Spectrum not centered around non zero frequency
  - May have a DC component
- **Bandpass Signal:**
  - Does not have a DC component
  - Finite bandwidth around or at  $f_c$

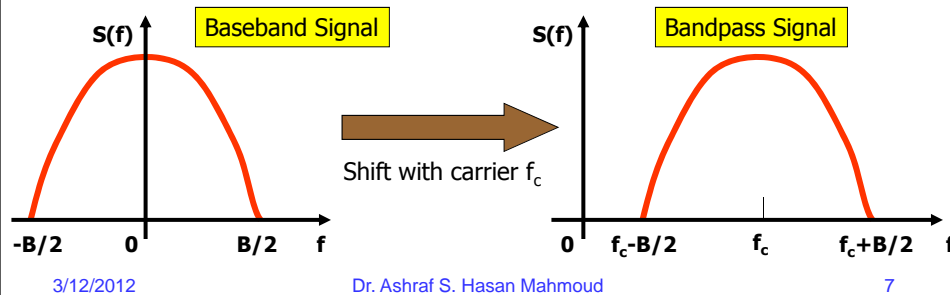

## Background

- **Digital Data, Digital Signaling:**
  - Less complex/expensive than digital-to-analog modulation equipment
- **Analog Data, Digital Signaling:**
  - Conversion of analog data to digital allows the use of modern digital tx and switching technology
- **Digital Data, Analog Signaling:**
  - Some transmission media can *ONLY* propagate analog signals – such as fiber optics and unguided
- **Analog Data, Analog Signaling:**
  - Analog data can be transmitted as baseband signals cheaply
  - Shifting bandwidth of baseband signals to occupy another portion of spectrum – different signals share same medium using frequency division multiplexing

3/12/2012

Dr. Ashraf S. Hasan Mahmoud

8

## Frequency Division Multiplexing

- Will be visited again in Chapter 8

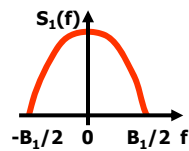

Shift with carrier  $f_{c1}$

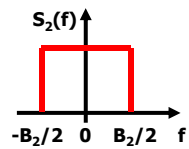

Shift with carrier  $f_{c2}$

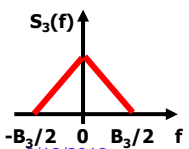

Shift with carrier  $f_{c3}$

$$x(t) = s_1(t) \times \cos(2\pi f_{c1}t) + s_2(t) \times \cos(2\pi f_{c2}t) + s_3(t) \times \cos(2\pi f_{c3}t)$$

- $x(t)$  is transmitted on the media
- The three spectra are not overlapping if  $f_{c1}$ ,  $f_{c2}$ , and  $f_{c3}$  are chosen appropriately
- Original composite signals  $s_1(t)$ ,  $s_2(t)$ , and  $s_3(t)$  can be recovered using bandpass filters with appropriate bandwidths centered at  $f_{c1}$ ,  $f_{c2}$ , and  $f_{c3}$ , respectively.

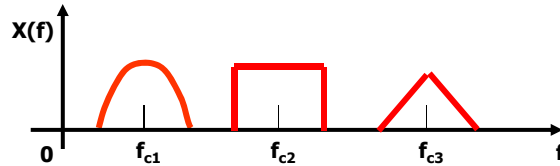

Dr. Ashraf S. Hasan Mahmoud

9

## Signal Elements or Pulses

- Unit of transmission – repeated to form the overall signal
- *Shape* of pulse determines the bandwidth of the transmitted signal
- Digital data is mapped or encoded to the different pulses or units of transmission

3/12/2012

Dr. Ashraf S. Hasan Mahmoud

10

# Signal Elements or Pulses

**Definitions of Pulses**      **Encoded Signal: 0 1 0 0 1 1 1 0**

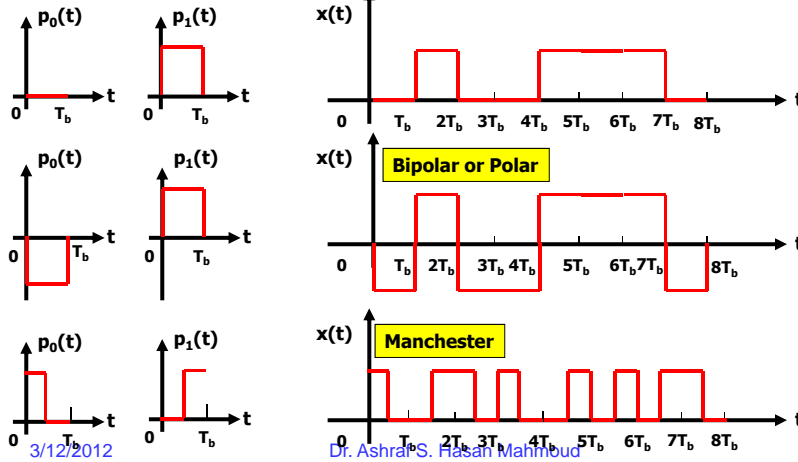

Examples of Digital Signaling

3/12/2012

Dr. Ashraf S. Hasan Mahmoud

11

# Signal Elements or Pulses

**Pluses Definitions**      **Encoded Signal: 0 1 0 0 1 1 1 0**

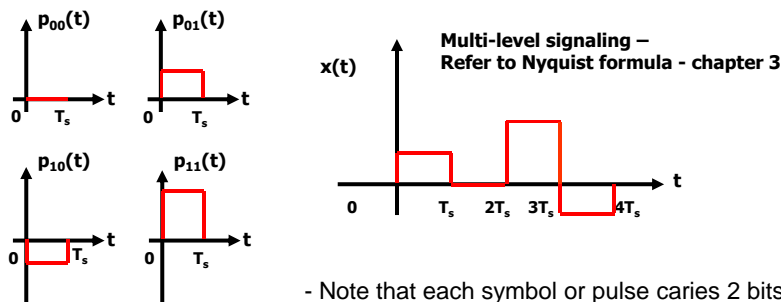

Example of Digital Signaling

- Note that each symbol or pulse carries 2 bits
- Symbol duration is  $T_s = 2T_b$
- Bit rate  $R$  equal to  $1/T_b$
- Symbol rate or *baud rate*  $R_s$  equal to  $1/T_s \rightarrow R = 2R_s$
- In general to encode  $n$  bits per pulse, you need  $2^n$  pulses

3/12/2012

Dr. Ashraf S. Hasan Mahmoud

12

# Signal Elements or Pulses

## Definitions of Pulses

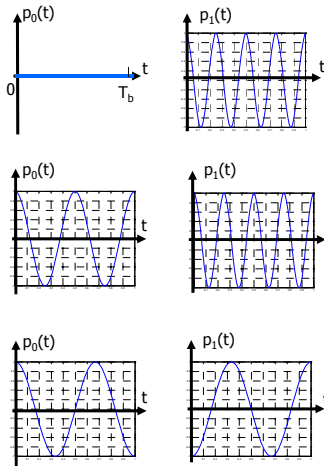

3/12/2012

## Encoded Signal:

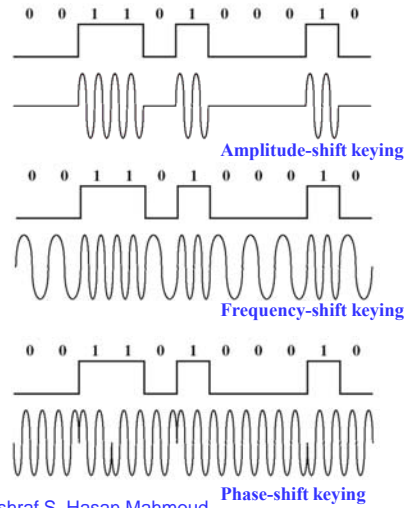

Dr. Ashraf S. Hasan Mahmoud

Example of Analog Signaling

13

# Digital Data – Digital Signals

- **Digital signal: sequence of discrete, discontinuous voltage pulses**
- **Digital data (bits) are encoded (or mapped) into signal elements**
- **Baud-rate: number of signal elements per second**
- **Mark – Space = 1 – 0**
- **Communication Tasks – Receiver must have:**
  - **Transmission elements timings**
  - **Pulse voltage level (to know whether it is 0 or 1 for example) – Rx samples at bit times to find voltage level**

3/12/2012

Dr. Ashraf S. Hasan Mahmoud

14

## Key Data Transmission Terms

Term	Units	Definition
Data element	Bits	A single binary one or zero
Data rate	Bits per second (bps)	The rate at which data elements are transmitted
Signal element	Digital: a voltage pulse of constant amplitude. Analog: a pulse of constant frequency, phase, and amplitude.	That part of a signal that occupies the shortest interval of a signaling code
Signaling rate or modulation rate	Signal elements per second (baud)	The rate at which signal elements are transmitted

3/12/2012

Dr. Ashraf S. Hasan Mahmoud

15

## How to Overcome Impairments?

- **Faults in detection of received signal register as BIT ERROR RATE at receiver – BER**
  - **A good communication channel has small or zero BER**
- **Factors:**
  - **SNR or  $E_b/N_0$**
  - **Data bit rate**
  - **Channel/system bandwidth**
  - **Encoding of data bits into signal elements**
- **Encoding scheme also affects bandwidth of signal**

3/12/2012

Dr. Ashraf S. Hasan Mahmoud

16



## Digital Signal Encoding Formats

- **Nonreturn to Zero-Level (NRZ-L)**
  - 0 = high level
  - 1 = low level
- **Nonreturn to Zero Inverted (NRZI)**
  - 0 = no transition at beginning of interval
  - 1 = transition at beginning of interval
- **Bipolar-AMI**
  - 0 = no line signal
  - 1 = +ve or -ve level; alternating successive ones
- **Pseudoternary**
  - 0 = +ve or -ve level; alternating for successive ones
  - 1 = no line signal
- **Manchester**
  - 0 = transition from high to low in middle of interval
  - 1 = transition from low to high in middle of interval
- **Differential Manchester: Always transition in middle of interval**
  - 0 = transition at beginning of interval
  - 1 = no transition at beginning of interval
- **Bipolar with 8 Zeros Substitution (B8ZS): same as bipolar AMI, except that any string of 8 zeros is replaced by a string with two code violations**
- **High Density bipolar-3 Zeros (HDB3): same as bipolar AMI, except that any string of 4 zeros is replaced by a string with one code violation**

3/12/2012

Dr. Ashraf S. Hasan Mahmoud

17

## Digital Signal Encoding Formats

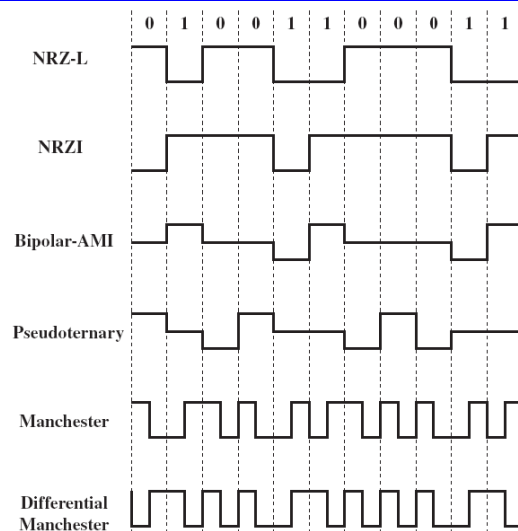

3/12/2012

Dr. Ashraf S. Hasan Mahmoud

18

## How to Evaluate Encoding Schemes?

---

- **Signal spectrum:**(remember this is dependent on pulse shape)
  - **Lack of high frequency component → lesser BW – signal does not required large BW - desirable**
  - **Lack of DC component - desirable**
- **Clocking (Synchronization):**
  - **Rxer needs to determine bit timing**
    - **Provide clock signal at receiver – EXPENSIVE**
    - **Derive clock signal from incoming signal**
  - **E.g. Differentiating a Manchester encoded signal results in the clock signal!**

3/12/2012

Dr. Ashraf S. Hasan Mahmoud

19

## How to Evaluate Encoding Schemes? (2)

---

- **Error detection:**
  - **Capability built into physical layer encoding – e.g. for pseudoternary successive ones have opposite signs**
  - **More sophisticated error detection and correction codes are used (Chapter 7)**
- **Signal interference and noise immunity**
  - **Certain codes are superior than others in the presence of noise and interference (i.e. give lower BER for same SNR or  $E_b/N_0$ )**
- **Cost and complexity:**
  - **Not a major factor compared to the rest of factors**
  - **In general, the higher the data rate the more expensive the hardware is**

3/12/2012

Dr. Ashraf S. Hasan Mahmoud

20

## Nonreturn to Zero (NRZ)

- **Nonreturn to Zero – Level (NRZ-L):**
  - Binary 0 – constant +ve level
  - Binary 1 – constant -ve level
- **Nonreturn to Zero – Invert on Ones (NRZI):**
  - Binary 0 – no transition at beginning of bit interval
  - Binary 1 – transition at beginning of bit interval
  - NRZI is an example of *differential encoding*:
    - If bit is equal to 1, bit encoding is opposite to previous bit
  - **Benefits of differential encoding**

3/12/2012

Dr. Ashraf S. Hasan Mahmoud

21

## Nonreturn to Zero (NRZ) (2)

- **Differential encoding – Involved memory (similar to sequential circuit design)**
- **Best represented using a state machine**

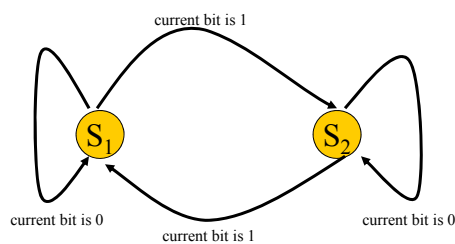

$S_1$ : output constant -ve level for  $T_b$   
 $S_2$ : output constant +ve level for  $T_b$

Nonreturn to Zero – Invert on Ones

3/12/2012

Dr. Ashraf S. Hasan Mahmoud

- **NO MEMORY**  
For RZ or NRZ-L

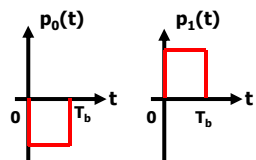
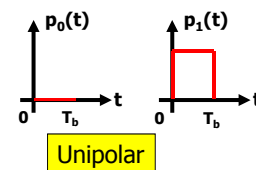

22

## Spectrum Characteristics of NRZ

- **Most of the energy in NRZ and NRZI signals is between DC and half of bit rate**
  - For example: When  $R = 9600$  b/s or  $T_b = 0.104$  msec, most of energy of the signal is between 0 Hz and 4800 Hz
- **Main limitations of NRZ:**
  1. presence of DC component
  2. lack of synchronization capability
  - Consider the case of a long string of ones or zeros:
    - One constant voltage level for long duration ( $\gg T_b$ ) – may cause drift in clock synchronization
- **Applications:**
  - Digital magnetic recording
  - Generally not used for signal transmission

3/12/2012

Dr. Ashraf S. Hasan Mahmoud

23

## Spectrum Characteristics of NRZ and Other Encoding Schemes

- Note the x-axis: normalized frequency ( $f/R$ )
  - E.g. value equal to 1.2, means  $f = 1.2 R$
- Schemes NRZ-L and NRZI have DC component
- Schemes B8ZS, HDB3, AMI, pseudoternary, Manchester and differential Manchester have no DC component
- NRZ-L, NRZI, B8ZS, HDB3, AMI, and pseudoternary have negligible energy beyond  $f = R$
- B8ZS, HDB3, AMI, and pseudoternary have their energy concentrated around  $f = R/2$
- Manchester and differential Manchester has significant energy concentration beyond  $f = R$  (because of the per bit transitions!)

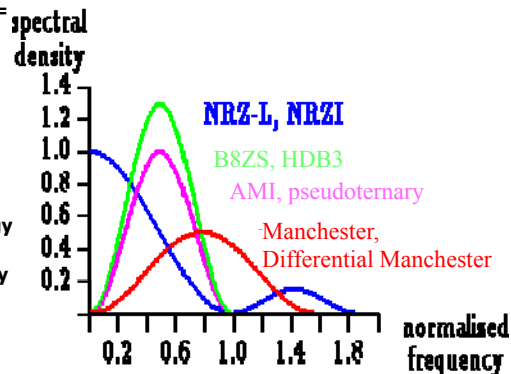

3/12/2012

Dr. Ashraf S. Hasan Mahmoud

24

## Multilevel Binary – Bipolar - AMI

- **Family of codes that uses more than two signal levels**
- **Bipolar-AMI:**
  - Binary 0 – no signal level
  - Binary 1 – +ve or -ve level; alternating
- **Advantages of Bipolar-AMI:**
  - Synch: long string of 1s is not a problem – but a long string of 0s is
  - No net DC component
  - Smaller BW compared to NRZ
  - Alternating pulses – simple error detection (no two consecutive ones can have same polarity)

3/12/2012

Dr. Ashraf S. Hasan Mahmoud

25

## Multilevel Binary – Pseudoternary

- **Pseudoternary:**
  - Binary 0 – +ve or -ve level; alternating
  - Binary 1 – no signal level
- **Same advantages as bipolar-AMI**
- **To provide clock synch info:**
  - Insert additional bits to force transition – used in ISDN for low bit rate connections – results in increased bit rate
  - Can not be used for already high bit rate connections – expensive
  - Use SCRAMBLING

3/12/2012

Dr. Ashraf S. Hasan Mahmoud

26

## NRZ V.S. Multilevel Binary

- **Spectrum:**
  - NRZ has DC component
  - Multilevel binary does not have DC component – smaller bandwidth
- **Synch:**
  - NRZ: long strings of 1s AND 0s present a problem
  - Multilevel binary: long strings of 0s for bipolar-AMI or long strings of 1s for pseudoternary present a problem

3/12/2012

Dr. Ashraf S. Hasan Mahmoud

27

## NRZ V.S. Multilevel Binary (2)

- **Efficiency:**
  - NRZ: two symbols – one for 0 and the other for 1 – i.e.  $\log_2 2 = 1$  information bit per symbol
  - Multilevel binary: three symbols – one for 0 and two for 1 (or the reverse for pseudoternary) – i.e.  $\log_2 3 = 1.58$  information bits per symbol
  - NRZ is more efficient – requires 3 dB less ( $1/2$ ) signal power to give same BER as Multilevel

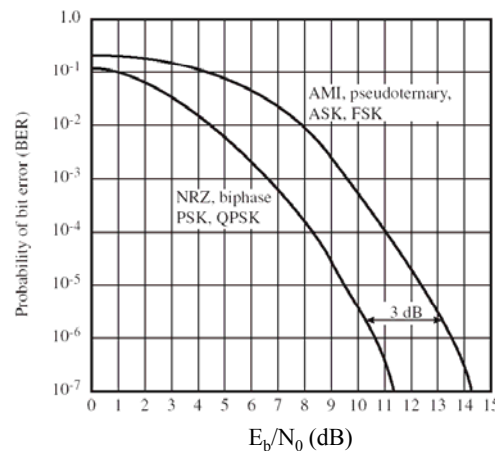

3/12/2012

Dr. Ashraf S. Hasan Mahmoud

28

## Biphase Encoding

- **Manchester: transition at the middle of each bit**
  - Binary 0 – high to low transition in the middle
  - Binary 1 – low to high transition in the middle
- **Differential Manchester: transition at the middle of each bit**
  - Binary 0 – transition at beginning of interval
  - Binary 1 – no transition at beginning of interval
- **THERE IS ALWAYS a TRANSITION at midbit – This provides the needed clock signal**
- **Biphase schemes require at least one transition per bit interval and sometimes two transitions per bit interval → Generate signal with higher frequency components compared to NRZ for same rate!!**

3/12/2012

Dr. Ashraf S. Hasan Mahmoud

29

## Advantages of Biphase Encoding

- **Synchronization:**
  - There is a predictable transition during each bit time
  - To derive clock signal – differentiate biphase signal
  - Biphase = Self clocking codes
- **No DC component**
- **Error Detection:**
  - A transition must happen at mid bit – if not present → ERROR
- **Applications:**
  - Manchester coding: IEEE 802.3 coaxial cable and TP CSMA/CD bus LANs
  - Differential Manchester: IEEE 802.5 token ring LANs on STP

3/12/2012

Dr. Ashraf S. Hasan Mahmoud

30

## Modulation Rate

- **Modulation (Baud) Rate - D:** number of symbols or signal elements transmitted per second
- **Data (or bit) Rate - R:** number of bits transmitted per second
- **$D = R/b$**  – where **b** is number of bits per symbol

Refer to slide number 12

3/12/2012

Dr. Ashraf S. Hasan Mahmoud

31

## Transitions Per Bit Time

- **The more transitions per bit time, the greater is the required bandwidth of the encoding scheme**

Encoding	Minimum	10101010...	Maximum
NRZ-L	0 (all 0s or 1s)	1.0	1.0
NRZI	0 (all 0s)	0.5	1.0 (all 1s)
Bipolar-AMI	0 (all 0s)	1.0	1.0
Pseudoternary	0 (all 1s)	1.0	1.0
Manchester	1.0 (10101...)	1.0	2.0 (all 0s or 1s)
Differential Manchester	1.0 (all 1s)	1.5	2.0 (all 0s)

Note that Manchester and differential Manchester encoding have the maximum number of transitions per bit time – This is the reason, their spectrum have significant components for  $f/R$  greater than 1.0 (refer to slide 24)



## Scrambling Techniques

- **Want to achieve:**

- **No DC component** → media
- **No long sequence of zero-level signals** → clocking/Synch
- **No reduction in data rate** → capacity
- **Error-detection capability** → reliability

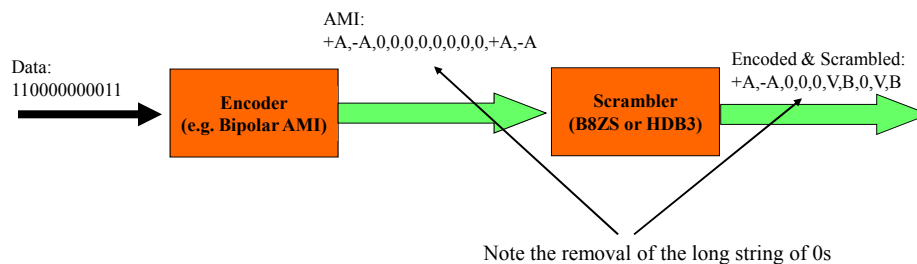

3/12/2012

Dr. Ashraf S. Hasan Mahmoud

33

## Bipolar with 8-Zeros Substitution (B8ZS)

- **Substitution Rules:**

- **If an octet of all zeros occurs and the last voltage pulse preceding the this octet was +ve, then the 8 zeros of the octet are encoded as 000+-0-+**
- **If an octet of all zeros occurs and the last voltage pulse preceding the this octet was -ve, then the 8 zeros of the octet are encoded as 000-+0+-**
- **Cause two code violations (signal patterns that are not allowed in AMI)**
- **Unlikely to be caused by noise**
- **Recognized by receiver and interpreted as 8 zeros**

3/12/2012

Dr. Ashraf S. Hasan Mahmoud

34

## High-Density Bipolar-3 Zeros (HDB3)

- **Substitution Rules:**
- **Replaces a string of 4 zeros with a pattern that contains 1 or 2 pulses.**
- **The fourth zero is replaced with a code violation**
- **Recognized by receiver and interpreted as 4 zeros**

Polarity of Preceding Pulse	Number of Bipolar Pulses (Ones) since Last Substitution	
	Odd	Even
-	000-	+00+
+	000+	-00-

3/12/2012

Dr. Ashraf S. Hasan Mahmoud

35

## B8ZS and HDB3

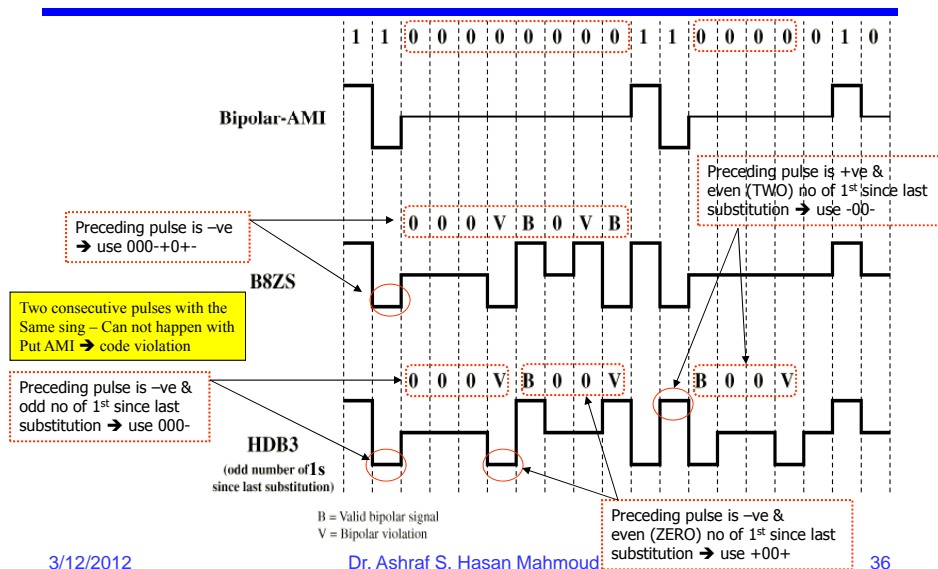

3/12/2012

Dr. Ashraf S. Hasan Mahmoud

36

## Digital Data – Analog Signals

- **Digital data (bits) transmitted using analog signals:**
  - E.g. computer-modem-PSTN
- **Subscriber-to-PSTN connection designed to carry analog (voice) signal from 300 Hz to 3400 Hz**
- **56K Modem – encodes data and generates a signal occupying the same range for voice signals → one line - one signal**
- **DSL Modem – encodes data and generates signal occupying higher range than that usually occupied by voice → one line – two signals**

3/12/2012

Dr. Ashraf S. Hasan Mahmoud

37

## Amplitude Shift Keying (ASK)

- **Analog pulses (signal elements) used are:**

$$s(t) = \begin{cases} A \cos(2\pi f_c t) & \text{bit} = 1 \\ 0 & \text{bit} = 0 \end{cases}$$

- **Spectrum of overall signal is centered around  $f_c$**

- **Application: on voice-grade lines used up to 1200 bps**

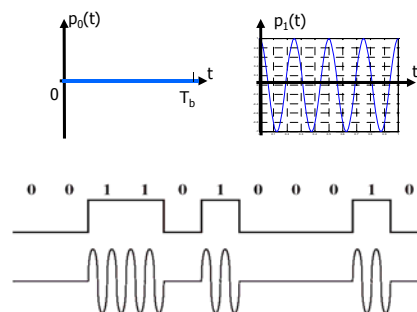

**This is called BASK**

3/12/2012

Dr. Ashraf S. Hasan Mahmoud

38

## Frequency Shift Keying (FSK)

- Analog pulses (signal elements) used are:

$$s(t) = \begin{cases} A \cos(2\pi f_1 t) & \text{bit} = 1 \\ A \cos(2\pi f_2 t) & \text{bit} = 0 \end{cases}$$

- Spectrum of overall signal is centered around  $f_1$  and  $f_2$

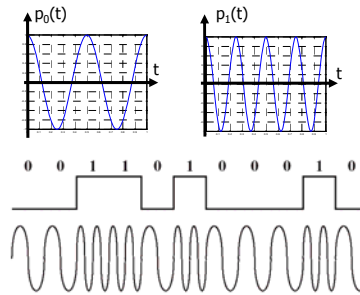

This is called BFSK

3/12/2012

Dr. Ashraf S. Hasan Mahmoud

39

## Frequency Shift Keying (FSK) (2)

- **Application: full duplex**
  - Direction 1:  $f_1 = 1070$  Hz,  $f_2 = 1270$  Hz
  - Direction 2:  $f_1 = 2025$  Hz,  $f_2 = 2225$  Hz
- **Less susceptible to errors (compared to ASK) – used for rates up to 1200 bps on voice-grade lines**

- Also used for high frequency (3 to 30 MHz) radio transmission
- LANs – coaxial cables

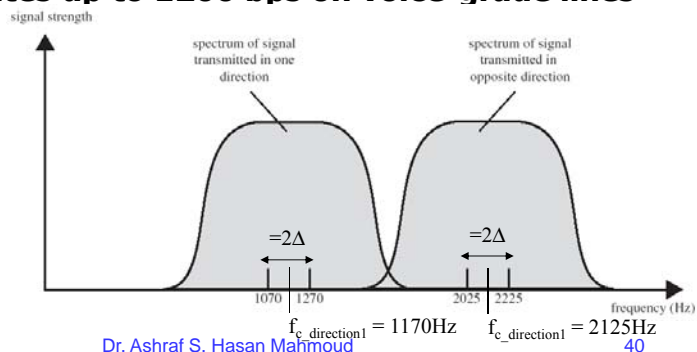

3/12/2012

Dr. Ashraf S. Hasan Mahmoud

40

## Phase Shift Keying (PSK)

- Analog pulses (signal elements) used are:

$$s(t) = \begin{cases} A \cos(2\pi f_c t + \pi) & \text{bit} = 1 \\ A \cos(2\pi f_c t) & \text{bit} = 0 \end{cases}$$

- Spectrum of overall signal is centered around  $f_c$

- Example of 2-phase (binary) system

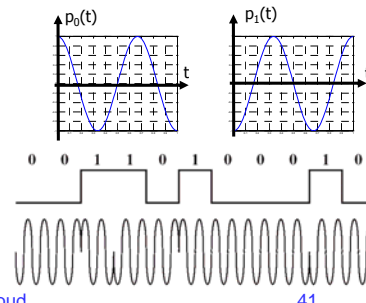

This is called BPSK

3/12/2012

Dr. Ashraf S. Hasan Mahmoud

41

## Multi-Level ASK

- ASK is also known as digital PAM – refer to PAM used for PCM encoding
- The transmitted symbols:

$$s_i(t) = A_i \cos(2\pi f_c t), \quad i = 1, 2, \dots, M \quad 0 \leq t \leq T_s$$

where

$$A_i = (2i-1-M)d, \quad i = 1, 2, \dots, M$$

$2d$  is distance between adjacent signal amplitudes

$M$  is number of different signal elements (the alphabet size) =  $2^L$

$L$  is number of bits per signal element or symbol

$T_s$  is the symbols duration.

- The energy for  $s_i(t)$ ,  $E_{i,r}$  is given by  $A_i^2 T_s / 2$

3/12/2012

Dr. Ashraf S. Hasan Mahmoud

42

## Multi-Level ASK - Examples

- **Examples:**

- **M = 2 – Binary ASK**

**A1 = -d, A2 = d**

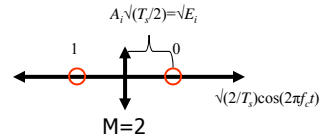

- **M = 4 – 4-level ASK**

**A1 = -3d, A2 = -d, A3 = d, A4 = 3d**

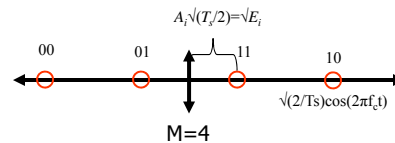

- **M = 8 – 8 level ASK**

**A1 = -7d, A2 = -5d, A3 = -3d, A4 = -d,  
A5 = d, A6 = 3d, A7 = 5d, A8 = 7d**

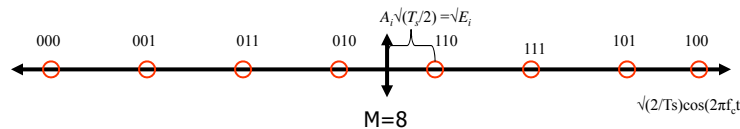

Note the grey coding!  
Adjacent symbols are different by 1 bit only.

asan Mahmoud

43

## Multi-Level PSK

- **The transmitted symbols:**

$$s_i(t) = A \cos(2\pi f_c t + \theta_i), \quad i = 1, 2, \dots, M \quad 0 \leq t \leq T_s$$

$$= A \{ \cos(\theta_i) \cos(2\pi f_c t) - \sin(\theta_i) \sin(2\pi f_c t) \}$$

where

$$\theta_i = 2\pi(i-1)/M, \quad i=1, 2, \dots, M.$$

**M** is number of different signal elements (the alphabet size) =  $2^L$

**L** is number of bits per signal element or symbol

**T<sub>s</sub>** is the symbols duration.

- **The energy for  $s_i(t)$ ,  $E_i$ , is given by  $A^2 T_s / 2$**

- **i.e. all symbols have equal energy  $\rightarrow E = A^2 T_s / 2!!$**

3/12/2012

Dr. Ashraf S. Hasan Mahmoud

44

# Multi-Level PSK - Examples

- **M = 2 – BPSK**  
 $\theta_1 = 0, \theta_2 = \pi$

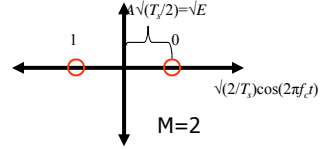

- **M = 4 – QPSK**  
 $\theta_1 = 0, \theta_2 = \pi/2,$   
 $\theta_3 = \pi, \theta_4 = 3\pi/2,$

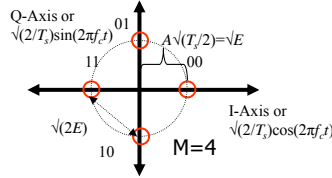

- **M = 8 – 8-PSK**  
 $\theta_1 = 0, \theta_2 = \pi/4, \theta_3 = \pi/2, \theta_4 = 3\pi/4,$   
 $\theta_5 = \pi, \theta_6 = 5\pi/4, \theta_7 = 3\pi/2, \theta_8 = 7\pi/4$

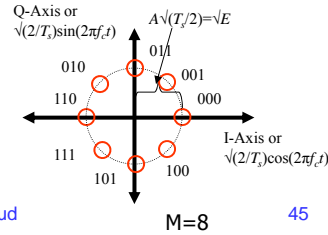

Note the grey coding!  
 Adjacent symbols are different by 1 bit only.

Dr. Ashraf S. Hasan Mahmoud

45

# Differential PSK Waveform

- (a) BPSK  
 $0 - A\cos(2\pi f_c t + \pi),$   
 $1 - A\cos(2\pi f_c t),$
- (b) DBPSK  
 same (a) symbols but  
 $0 -$  uses the same phase as previous bit  
 $1 -$  use opposite phase to the previous bit
- (c) DBPSK  
 same as (b) except the  $\sin()$  is used instead of  $\cos()$

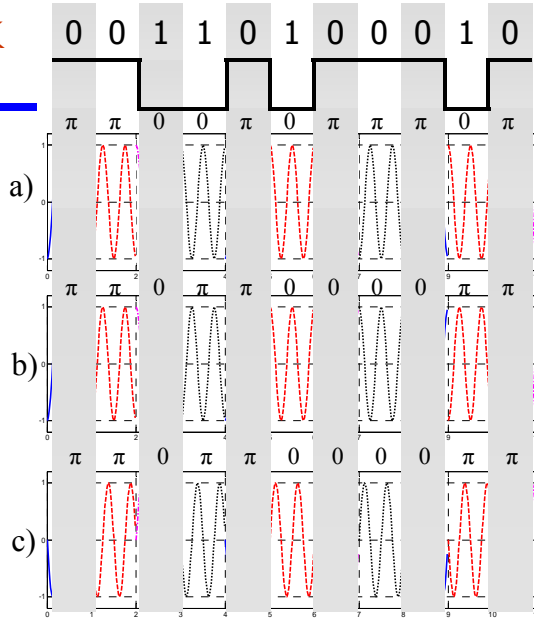

Compare (c) with Figure 5.10 of textbook

3/12/2012

Dr. Ashraf S. Hasan Mahmoud

46

## Four Level PSK - (QPSK)

- On slide 45 we used:
  - $\theta_1 = 0, \theta_2 = \pi/2, \theta_3 = \pi, \theta_4 = 3\pi/2$
- But we could use (as in the textbook page 146):
  - $\theta_1 = \pi/4, \theta_2 = 3\pi/4, \theta_3 = -3\pi/4, \theta_4 = -\pi/4$
- Therefore the transmitted symbols are:

$$s_i(t) = \begin{cases} A \cos(2\pi f_c t + \pi/4) & 11 \\ A \cos(2\pi f_c t + 3\pi/4) & 01 \\ A \cos(2\pi f_c t - 3\pi/4) & 00 \\ A \cos(2\pi f_c t - \pi/4) & 10 \end{cases}$$

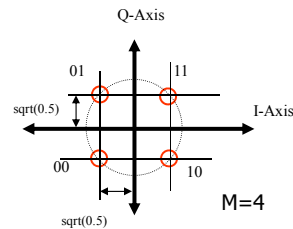

3/12/2012

Dr. Ashraf S. Hasan Mahmoud

47

## QPSK/OQPSK Waveform

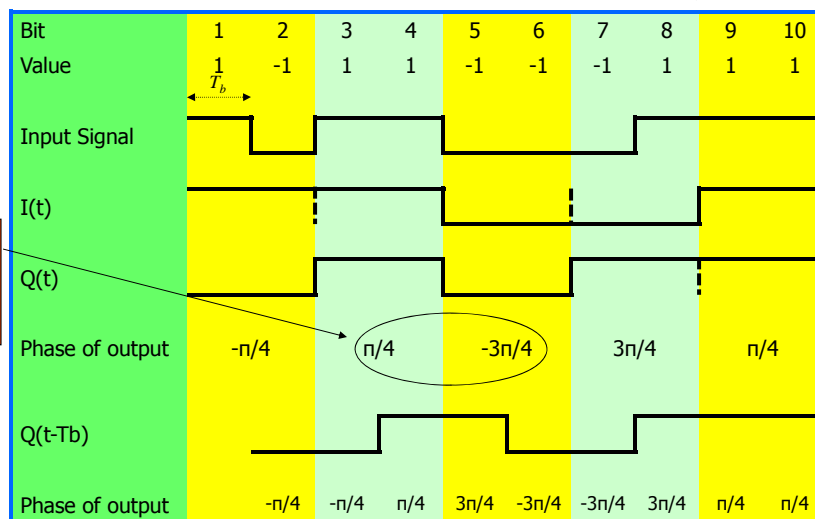
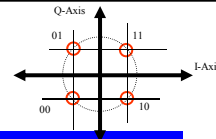

A change in phase equal to  $\pi$  - Can not occur with OQPSK!!

3/12/2012

Dr. Ashraf S. Hasan Mahmoud

48



## QPSK/OQPSK Modulator

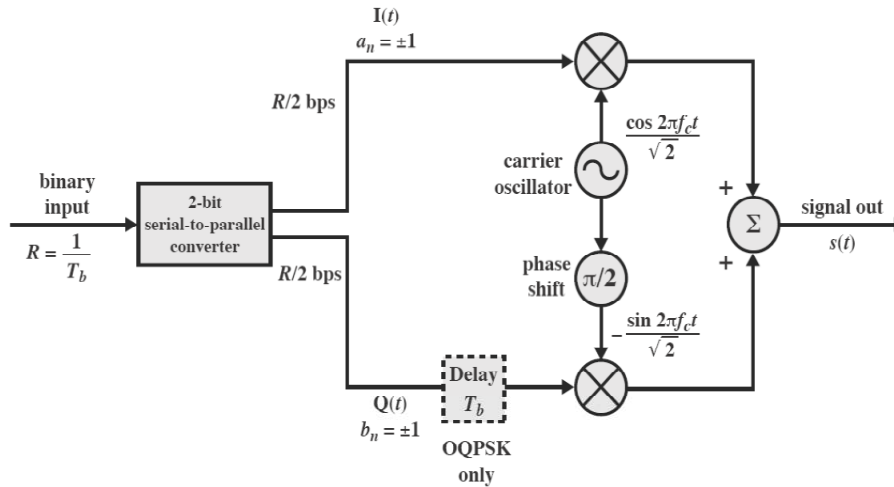
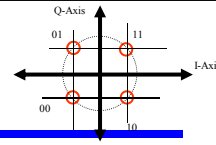

3/12/2012

Dr. Ashraf S. Hasan Mahmoud

49

## Encoding Techniques – Quadrature Phase Shift Keying (QPSK)

- One can extend this scheme to obtain: **8PSK** for example
- One can use ASK together with PSK to get more signal elements – e.g. 9600 kb/s modem uses 12 phase angles four of which have higher amplitude values
  - For this example:  $L = 4$   
(i.e. every signal element carries 4 bits)
- In general:  
 $D = R/L = \log_2 M$   
 where  $D$ : modulation rate or baud rate  
 $R$ : data rate, bps  
 $M$ : # of signal levels  
 $L$ : # of bits per signal element

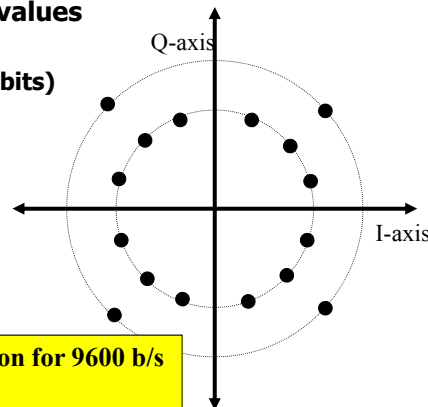

Signal Constellation for 9600 b/s modem standard

3/12/2012

Dr. Ashraf S. Hasan Mahmoud

50

## Multi-Level FSK (MFSK)

- Analog pulses (signal elements) used are:

$$s_i(t) = A \cos(2\pi f_i t) \quad 1 \leq i \leq M$$

- Where

- $f_i = f_c + (2i-1-M)f_d$
- $f_c$ : carrier frequency
- $f_d$ : the difference frequency
- M: number of different signal elements (the alphabet size) =  $2^L$
- L: number of bits per signal element or symbol

3/12/2012

Dr. Ashraf S. Hasan Mahmoud

51

## MFSK Example – M = 4

- Example – M = 4

- f1 =  $f_c - 3f_d \rightarrow 00$
- f2 =  $f_c - f_d \rightarrow 01$
- f3 =  $f_c + f_d \rightarrow 10$
- f4 =  $f_c + 3f_d \rightarrow 11$

Note this scheme does not utilize grey coding!! Why?

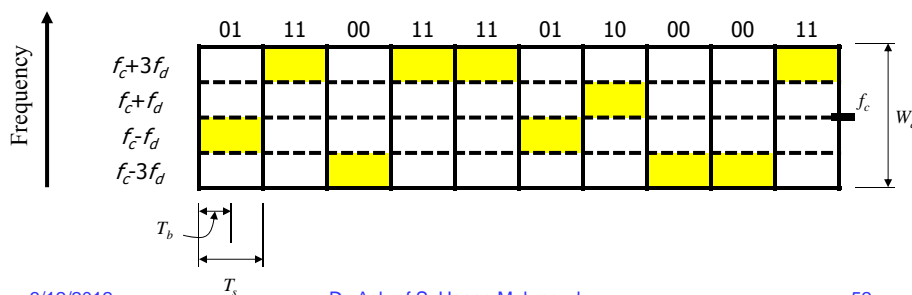

3/12/2012

Dr. Ashraf S. Hasan Mahmoud

52

## Performance - Bandwidth

- Signal (ASK, PSK, FSK, etc) BW depend on:

- Definition of BW
- Filtering technique

Encoding Scheme	BW (Signal Spectrum)
M-ASK	$B_T = (1+r)D$
M-PSK	$B_T = (1+r)D$
FSK (M=2)	$B_T = 2\Delta f + (1+r)R$
FSK (M > 2)	$B_T = (1+r)MD$

- $r$  – depends on filtering technique ( $0 < r < 1$ )
- For BFSK:  $\Delta f = f_2 - f_c = f_c - f_1$

- For multi-level ASK/PSK

$$B_T = (1+r)D = (1+r)R/L = (1+r)/\log_2 M \times R$$

- $R/B_T$  = data rate to transmission bandwidth  $\rightarrow$  **Bandwidth Efficiency**

- The higher this number the more efficient the scheme is (i.e. less number of Hzs is required to transmit the bits)

3/12/2012

Dr. Ashraf S. Hasan Mahmoud

53

## Performance – Bit Error Rate (BER)

- In presence of noise and in terms of BER: PSK and QPSK are 3 dB better than ASK And FSK

- Recall that  $E_b/N_0$  is equal to

$$\frac{E_b}{N_0} = \frac{S/R}{N/B_T} = \frac{S}{N} \times \frac{B_T}{R} = \text{SNR} \times \frac{1}{\text{BW efficiency}}$$

- Hence, one can decrease BER (i.e. increase  $E_b/N_0$ ) by either increasing SNR, increasing the transmission bandwidth ( $B_T$ ), or reducing the data rate (R)

- For multi-level signaling – Replace R with D

This formula is valid for D/R = b = 1 (1 symbol = 1 bit)

3/12/2012

Dr. Ashraf S. Hasan Mahmoud

54

## Performance – Example

- What is the bandwidth efficiency for FSK, ASK, PSK, and QPSK for a BER of  $10^{-7}$  on a channel with SNR = 12 dB

- Solution

- Bandwidth efficiency =  $R/B_T$   
 $E_b/N_0 = \text{SNR} / (R/B_T)$  or  
 $(E_b/N_0)_{\text{dB}} = \text{SNR}_{\text{dB}} - (R/B_T)_{\text{dB}}$

Therefore,  
 $(R/B_T)_{\text{dB}} = \text{SNR}_{\text{dB}} - (E_b/N_0)_{\text{dB}}$   
 $= 12 - (E_b/N_0)_{\text{dB}}$

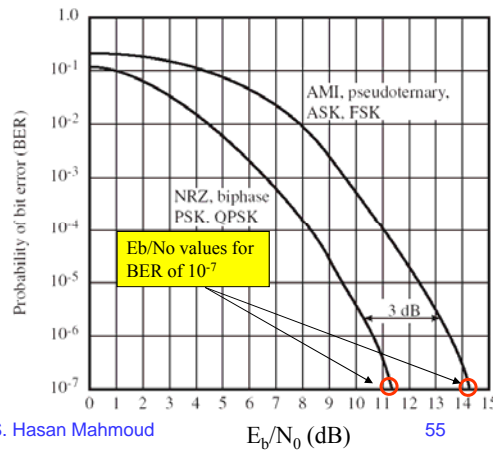

3/12/2012

Dr. Ashraf S. Hasan Mahmoud

$E_b/N_0$  (dB)

55

## Performance – Example – cont'd

- What is the bandwidth efficiency for FSK, ASK, PSK, and QPSK for a BER of  $10^{-7}$  on a channel with SNR = 12 dB

- Solution

Using the BER curves (previous slide):

(for ASK & FSK)  $\text{BER} = 10^{-7} \rightarrow (E_b/N_0)_{\text{dB}} = 14.2 \text{ dB}$   
Hence,  $(R/B_T)_{\text{dB}} = 12 - 14.2 = -2.2 \text{ dB}$ , or  $R/B_T = 0.6$

(for PSK)  $\text{BER} = 10^{-7} \rightarrow (E_b/N_0)_{\text{dB}} = 11.2 \text{ dB}$   
Hence,  $(R/B_T)_{\text{dB}} = 12 - 11.2 = 0.8 \text{ dB}$ , or  $R/B_T = 1.2$

(for QPSK) same curve as PSK  $\rightarrow (E_b/N_0)_{\text{dB}} = 11.2 \text{ dB}$   
Hence,  $(D/B_T)_{\text{dB}} = 12 - 11.2 = 0.8 \text{ dB}$ , or  
 $D/B_T = 1.2$  and  $R/B_T = 2.4$  (since  $D = R/2$  for QPSK)

BW Efficiency: 0.6  $\rightarrow$  1.2  $\rightarrow$  2.4

3/12/2012

Dr. Ashraf S. Hasan Mahmoud

56

## Performance – Bandwidth Efficiency

### Bandwidth Efficiency for various digital-to-analog encoding schemes.

	$r = 0$	$r = 0.5$	$r = 1.0$
<b>ASK</b>	1.0	0.67	0.5
<b>FSK</b>			
Wideband ( $\Delta F \gg R$ )	$\sim 0$	$\sim 0$	$\sim 0$
Narrowband ( $\Delta F \approx f_c$ )	1.0	0.67	0.5
<b>PSK</b>			
<b>Multilevel signaling</b>			
$M=4, L=2$	2.00	1.33	1.00
$M=8, L=3$	3.00	2.00	1.5
$M=16, L=4$	4.00	2.67	2.00
$M=32, L=5$	5.00	3.33	2.5

3/12/2012

Dr. Ashraf S. Hasan Mahmoud

57

## Performance – cont'd

- Theoretical bit error rate for (a) Multilevel FSK and (b) Multilevel PSK.

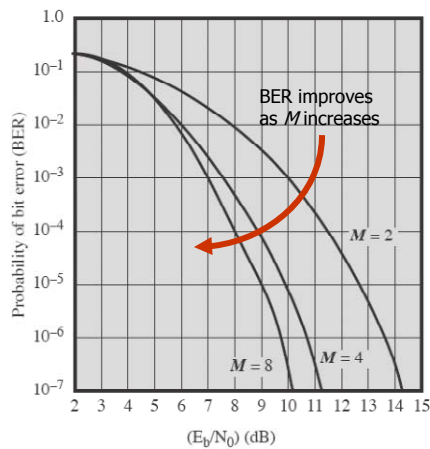

3/12/2012

(a)

Dr. Ashraf S. Hasan Mahmoud

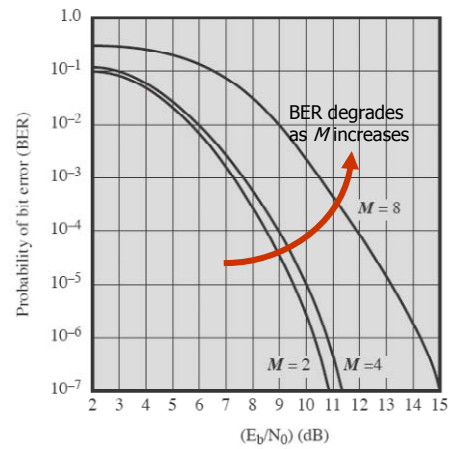

58

(b)

## Quadrature Amplitude Modulation (QAM)

- Popular analog signaling technique – used in ADSL
- A combination of ASK and PSK
- Example signal constellations:

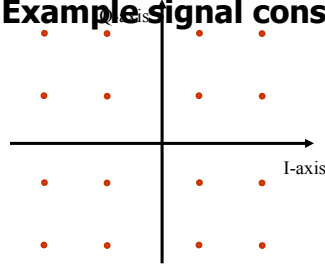

16 QAM

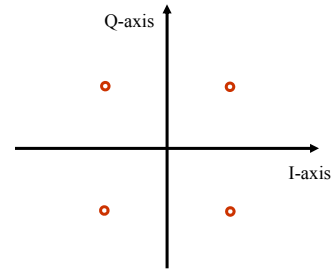

4 QAM  
(similar to QPSK with  
 $\theta_1 = \pi/4, \theta_2 = 3\pi/4,$   
 $\theta_3 = -3\pi/4, \theta_4 = -\pi/4$  –  
refer to slide 47

3/12/2012

Dr. Ashraf S. Hasan Mahmoud

59

## Quadrature Amplitude Modulation (QAM)

- Signal given by:  
 $s(t) = d_1(t) \cos(2\pi f_c t) + d_2(t) \sin(2\pi f_c t)$

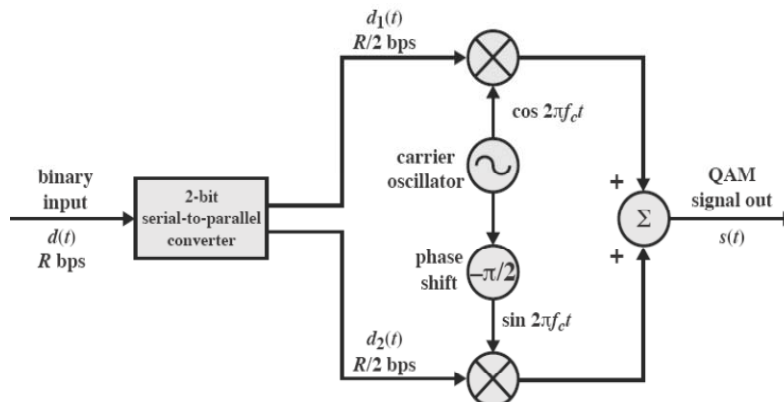

3/12/2012

Dr. Ashraf S. Hasan Mahmoud

60

## Example: Problem 5-11

5-10. The figure below shows the QAM demodulator corresponding to the QAM modulator shown in previous slide. Show that this arrangement DOES recover the two signals  $d_1(t)$  and  $d_2(t)$ , which can be combined to recover the original signal.

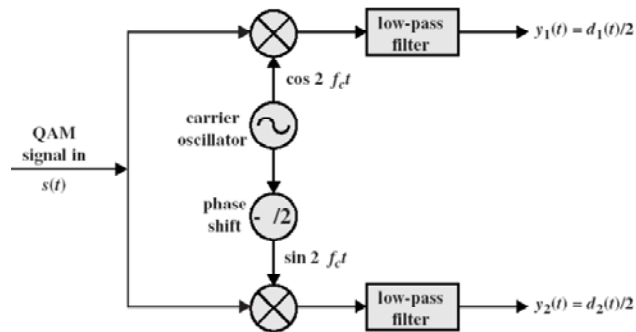

3/12/2012

Dr. Ashraf S. Hasan Mahmoud

61

## Example: Problem 5-11 - Solution

### Solution:

$$s(t) = d_1(t)\cos(\omega_c t) + d_2(t)\sin(\omega_c t)$$

Use the following identities:

$$\cos(2\alpha) = 2\cos^2(\alpha) - 1; \sin^2(\alpha) = 2\sin(\alpha)\cos(\alpha)$$

For upper branch:

$$\begin{aligned} s(t) \times \cos(\omega_c t) &= d_1(t)\cos(2\omega_c t) + d_2(t)\sin(\omega_c t)\cos(\omega_c t) \\ &= (1/2)d_1(t) + (1/2)d_1(t)\cos(2\omega_c t) + (1/2)d_2(t)\sin(2\omega_c t) \end{aligned}$$

Use the following identities:

$$\cos(2\alpha) = 1 - 2\sin^2(\alpha); \sin^2(\alpha) = 2\sin(\alpha)\cos(\alpha)$$

For lower branch:

$$\begin{aligned} s(t) \times \sin(\omega_c t) &= d_1(t)\cos(\omega_c t)\sin(\omega_c t) + d_2(t)\sin(2\omega_c t) \\ &= (1/2)d_1(t)\sin(2\omega_c t) + (1/2)d_2(t) - (1/2)d_2(t)\cos(2\omega_c t) \end{aligned}$$

All terms at  $2\omega_c$  are filtered out by the low-pass filter, yielding:

$$y_1(t) = (1/2)d_1(t); \quad y_2(t) = (1/2)d_2(t)$$

3/12/2012

Dr. Ashraf S. Hasan Mahmoud

62

## Analog Data – Digital Signal

- **Analog Data is “Digitized”** i.e converted to digital
- **Once in digital form:**
  - Use Digital signaling (NRZ-L, etc)
  - Use Analog Signaling (ASK, FSK, etc) – Shown in figure below
- **CODEC: Device for converting analog data to digital for transmission – and for recovering original analog data**

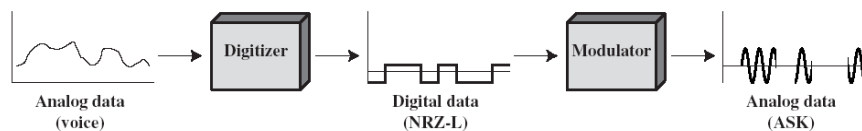

3/12/2012

Dr. Ashraf S. Hasan Mahmoud

63

## CODEC Procedures

- **Two main procedures are used in CODECs:**
  - 1. Pulse Code Modulation (PCM)**
  - 2. Delta Modulation**

3/12/2012

Dr. Ashraf S. Hasan Mahmoud

64



## Pulse Code Modulation (PCM)

- A scheme for digitizing ANALOG data
- For flash animation of PCM procedure click [HERE](#)
- Procedure:
  - **SAMPLING:** Analog signal is sampled (The rate of sampling SHOULD BE greater than twice the highest frequency – refer to the sampling theorem) → Result: Analog Samples
  - **QUANTIZATION:** Analog samples are mapped to discrete levels and each level is given a binary code → Result: binary word for each sample
    - Example: if we decide to use 256 discrete levels, then every level will have 8-bit word – correspondingly, every analog sample will be translated into 8 bits

3/12/2012

Dr. Ashraf S. Hasan Mahmoud

65

## Pulse Amplitude Modulation (PAM)

- Sampling Frequency,  $f_s = 2Xf_m$
- Sampling Time,  $T_s = 1/f_s = 1/(2Xf_m)$

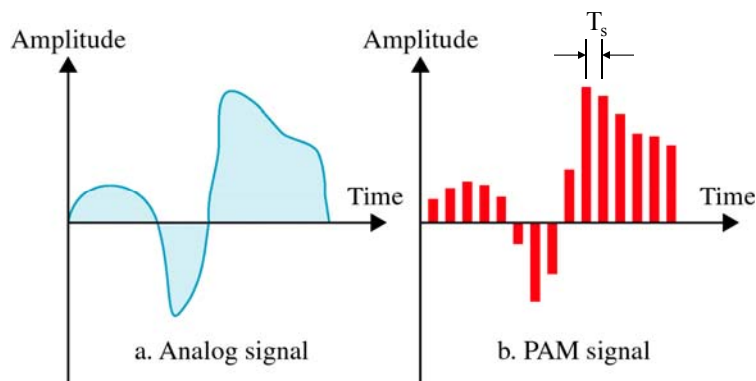

3/12/2012

Dr. Ashraf S. Hasan Mahmoud

Figure from package by Forouzan

66

# Quantization

- Analog samples are **ROUNDED** to **DISCRETE** levels (finite number of levels)
- For  $N$  bits per word  $\rightarrow$  we have  $2^N$  levels

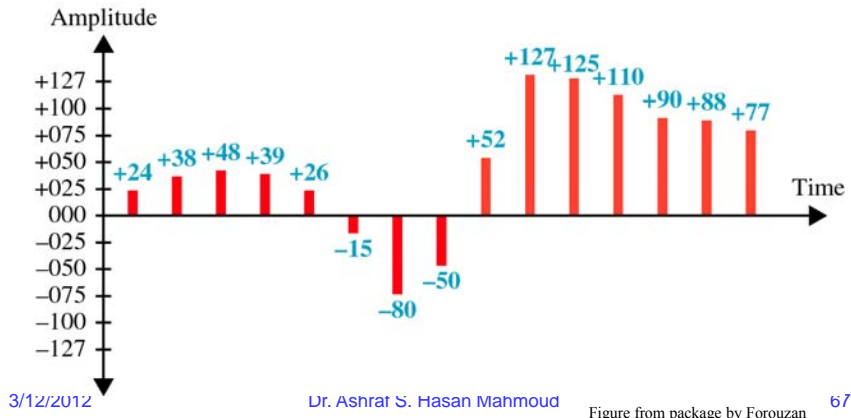

# Quantization – PCM

- $N$ -bit word is then generated for every sample

+024	00011000	-015	10001111	+125	01111101
+038	00100110	-080	11010000	+110	01101110
+048	00110000	-050	10110010	+090	01011010
+039	00100111	+052	00110110	+088	01011000
+026	00011010	+127	01111111	+077	01001101

Sign bit  
+ is 0 - is 1

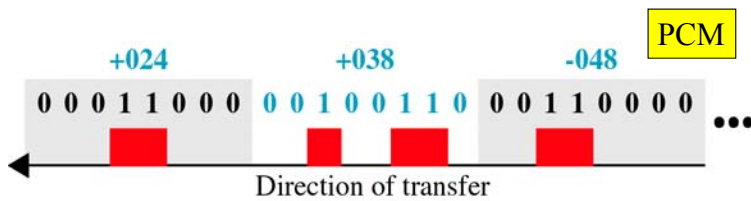

## PCM – overall picture

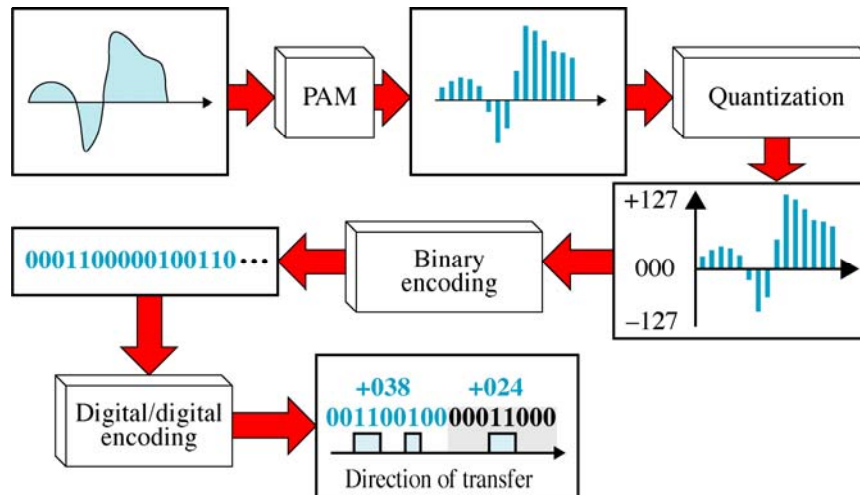

3/12/2012

Dr. Ashraf S. Hasan Mahmoud

Figure from package by Forouzan 69

## Pulse Code Modulation - SNR

- SNR is given by

$$\text{SNR} = 6.02n + 1.76 \text{ dB}$$

Where  $n$  is the number of bits per word/sample

- Assumes uniform distribution of signal level
- Errors: difference between quantized samples and original analog samples → QUANTIZATION NOISE
- Thermal noise is NOT accounted for
- NOTE:
  - As number of bits is increased (less rounding errors), SNR increases by 6 dB every extra bit

3/12/2012

Dr. Ashraf S. Hasan Mahmoud

70

## Pulse Code Modulation – Linear vs. Nonlinear Quantization

- **Linear quantization: equally spaced levels**  
 → magnitude of quantization error is same for large amplitude samples and small amplitude samples >> low signal levels are more affected by quantization errors
- **Solution:** to increase "resolution" in the low signal level region →
  - increase total number of levels OR
  - use companding function before quantization
- **For shown figure:**
  - Relative error for  $X_2$  is much greater than that for  $X_1$
  - Relative error is equal to  $\Delta$  (quantization error) divided by original signal level

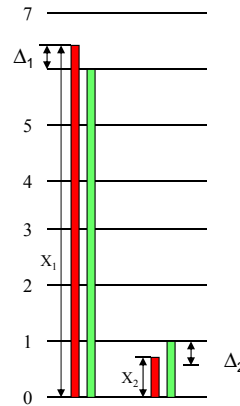

3/12/2012

Dr. Ashraf S. Hasan Mahmoud

71

## Pulse Code Modulation – Linear vs. Nonlinear Quantization (2)

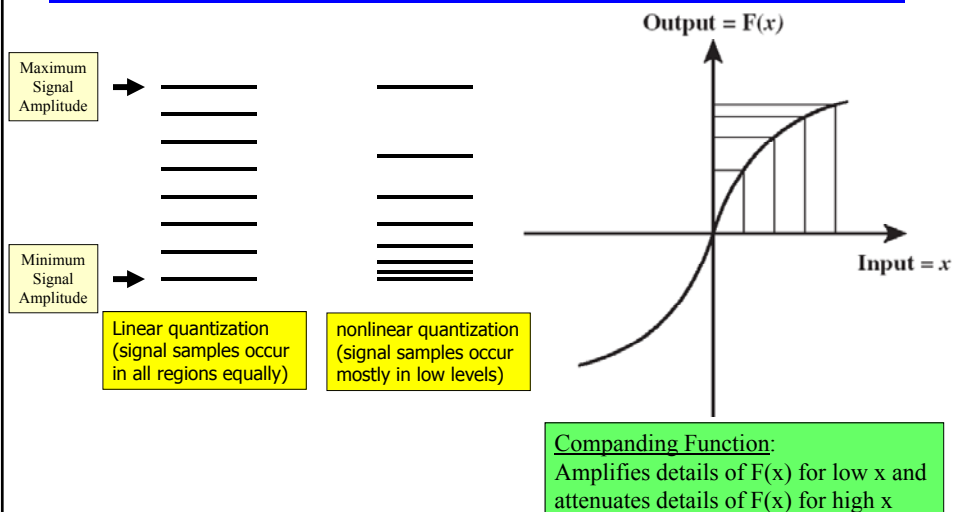

3/12/2012

Dr. Ashraf S. Hasan Mahmoud

72

## Example: Problem 5-20

---

**5-19: Consider an audio signal with spectral components in the range of 300 to 3000 Hz. Assuming a sampling rate of 7000 samples per second will be used to generate the PCM signal.**

- a) For SNR = 30 dB, what is the number of uniform quantization levels needed?**
- b) What data rate is required?**

## Example: Problem 5-20 - Solution

---

**a)  $(SNR)_{dB} = 6.02 n + 1.76 = 30 \text{ dB}$   
 $n = (30 - 1.76)/6.02 = 4.69$   
Rounded off,  $n = 5 \text{ bits}$   
This yields  $2^5 = 32 \text{ quantization levels}$**

**b)  $R = 7000 \text{ samples/s} \times 5 \text{ bits/sample} = 35 \text{ Kbps}$**

# Sigma-Delta Modulation

- Approximates the signal by a staircase function that moves up or down one quantization level ( $\delta$ ) every step (sampling time  $T_s$ )
- Transition up or down occurs at sampling instant
- **Slope overload:** function increasing/decreasing at a rate faster than  $\delta/T_s$  – staircase function can not catch up with original signal
- We still have **quantization noise** – rounding of original signal level

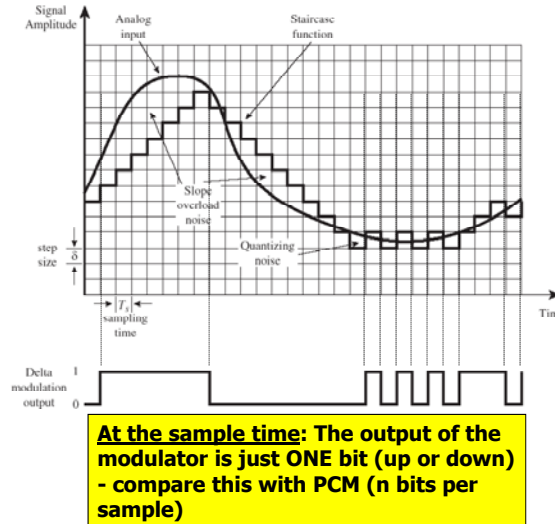

3/12/2012

Dr. Ashraf S. Hasan Mahmoud

COMPRESSION

75

# Sigma-Delta Modulation( 2)

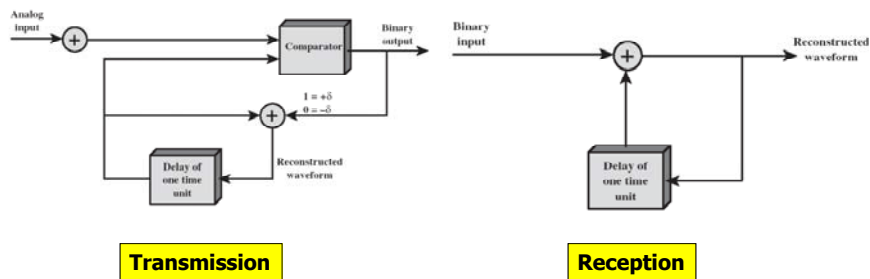

- **Ways to improve over Delta Modulation:**
  - Adaptive step delta modulation

3/12/2012

Dr. Ashraf S. Hasan Mahmoud

76

## Analog Data – Analog Signals

- Two principle reasons for analog modulation of analog signals:
  - High frequency may be more effective for transmission
  - Use of FDM (refer to [slide 9: Frequency Division Multiplexing](#))

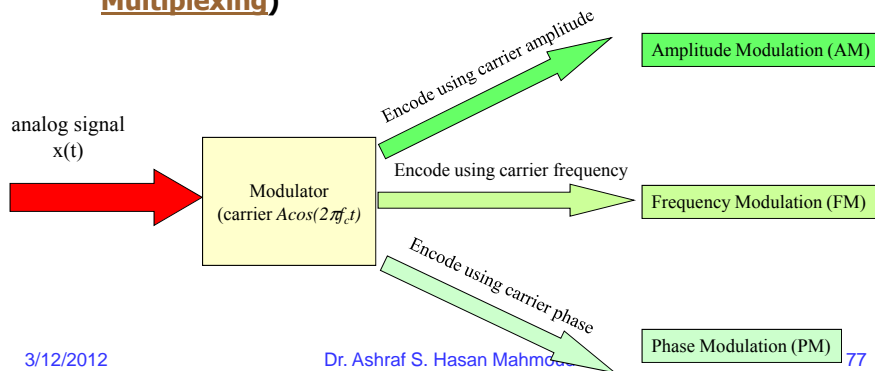

## Amplitude Modulation (AM)

- Simplest form of modulation:

$$s(t) = [1 + n_a x(t)] \cos(2\pi f_c t)$$

where  $\cos(2\pi f_c t)$  is the carrier

$x(t)$  is the input signal (carrying data)

$n_a$  is modulation index (control parameter)

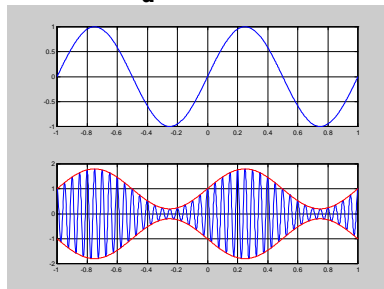

Information is "the envelope" of the overall signal  $s(t)$   
To preserve the envelope,  $n_a$  should be  $< 1$ ; for  $n_a > 1$ ,  
The envelope crosses the x-axis (info is lost)

3/12/2012

Dr. Ashraf S. Hasan Mahmoud

78

## Bandwidth of AM signal

- $S(t)$  has a double sided spectrum function centered around  $f_c$  – in addition to the carrier itself → Double sideband transmitted carrier (DSBTC)
- If  $B$  is the bandwidth of  $x(t)$ , the required transmission bandwidth for the AM signal is  $B_T = 2B$

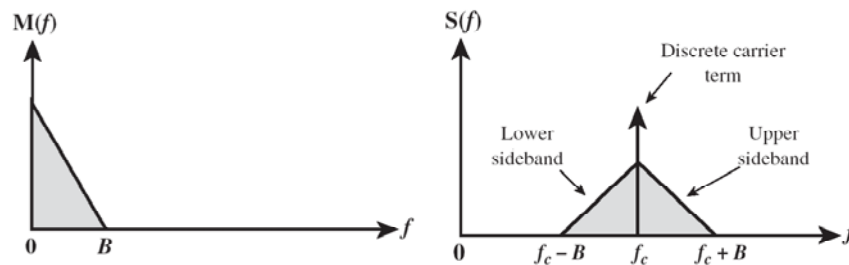

3/12/2012

Dr. Ashraf S. Hasan Mahmoud

79

## Power of AM signal

- Total signal power:  $P_t = P_c(1+n_a^2/2)$ , where  $P_c$  is the transmitted power in carrier
- $s(t)$  contains extra info: the carrier itself – removal of carrier (i.e  $s(t) = m(t)\cos(2\pi f_c t)$ ) is referred to as double sideband suppressed carrier (DSBSC)
- DSBSC signal has same BW as DSBTC
- Carrier info is useful in helping receiver lock to exact frequency and phase of carrier

3/12/2012

Dr. Ashraf S. Hasan Mahmoud

80



## Frequency Modulation (FM)

- Simplest form of modulation:

$$s(t) = A_c \cos(2\pi f_c t + \phi(t))$$

$$\phi'(t) = n_f m(t)$$

where  $A_c/f_c$  are the amplitude/frequency of carrier

$m(t)$  is the input signal (carrying data)

$n_f$  is frequency modulation index (control parameter)

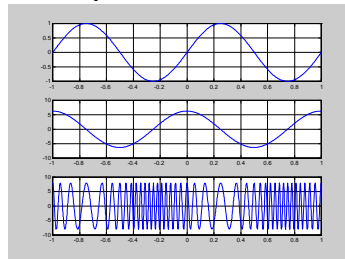

Instantaneous frequency of  $s(t)$ ,  
 $f_i(t)$ , is equal to  $f_c + n_f m(t)/(2\pi)$

3/12/2012

Dr. Ashraf S. Hasan Mahmoud

81

## Bandwidth/Power of FM signal

- If  $B$  is the bandwidth of  $m(t)$ , the required transmission bandwidth for the FM signal is

$$B_T = 2(1+\beta)B$$

$$\beta = \Delta F/B = n_f A_m/(2\pi B)$$

- $\Delta F$  is the peak deviation around  $f_c$ ,  $A_m$  is the maximum amplitude of  $m(t)$ . Note  $\Delta F = n_f A_m/(2\pi)$
- Note  $B_T$  for PM signal is greater than that of AM signal
- Power of FM signal:  $A_c^2/2$

3/12/2012

Dr. Ashraf S. Hasan Mahmoud

82

## Phase Modulation (PM)

- Simplest form of modulation:

$$s(t) = A_c \cos(2\pi f_c t + \phi(t))$$

$$\phi(t) = n_p m(t)$$

where  $A_c/f_c$  are the amplitude/frequency of carrier

$m(t)$  is the input signal (carrying data)

$n_p$  is phase modulation index (control parameter)

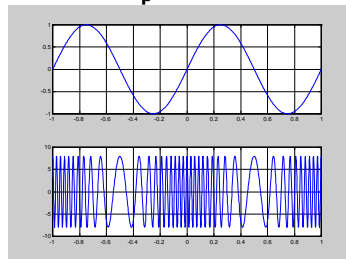

Instantaneous phase of  $s(t)$ ,  $\phi(t)$ , is equal to  $n_p m(t)$

3/12/2012

Dr. Ashraf S. Hasan Mahmoud

83

## Bandwidth/Power of PM signal

- If  $B$  is the bandwidth of  $m(t)$ , the required transmission bandwidth for the FM signal is

$$B_T = 2(1+\beta)B$$

$$\beta = n_p A_m$$

- Note  $B_T$  for PM signal is greater than that of AM signal
- Power of PM signal:  $A_c^2/2$

3/12/2012

Dr. Ashraf S. Hasan Mahmoud

84

## Example: Problem 5-24

---

- Consider the angle modulation signal

$$s(t) = 10 \cos(10^8\pi t + 5\sin(2\pi(10^3)t))$$

Find the maximum phase deviation and the maximum frequency deviation

**Solution:**

$$s(t) = A_c \cos[2\pi f_c t + \phi(t)] = 10 \cos [(10^8)\pi t + 5 \sin(2\pi(10^3)t)]$$

Therefore,

$$\phi(t) = 5 \sin 2\pi(10^3)t,$$

and the maximum phase deviation is 5 radians.

For frequency deviation, recognize that the change in frequency is determined by the derivative of the phase:

$$\phi'(t) = 5 (2\pi) (10^3) \cos [2\pi(10^3)t]$$

which yields a frequency deviation of  $\Delta f = 1/(2\pi)[5(2\pi)(10^3)] = 5 \text{ kHz}$

3/12/2012

Dr. Ashraf S. Hasan Mahmoud

85

## Textbook Problems of INTEREST

---

- Textbook Problems of Interest List: 5-4, 5-5, 5-6, 5-7, 5-8, 5-9, 5-11<sup>s</sup>, 5-12, 5-13, 5-14, 5-16, 5-19, 5-20<sup>s</sup>, 5-21, 5-22, 5-23, 5-24<sup>s</sup>, 5-25, and 5-26

3/12/2012

Dr. Ashraf S. Hasan Mahmoud

86