

**Problem Solutions to Problems Marked With a * in
Logic Computer Design Fundamentals, Ed. 2**

CHAPTER 3

© 2000 by Prentice-Hall, Inc.

3-2.

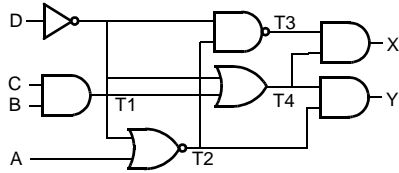

$$\begin{aligned} T1 &= BC, & T2 &= \overline{A}D \\ T3 &= 1, & T4 &= \overline{D} + BC \\ X &= T3T4 \\ &= \overline{D} + BC \\ Y &= T2T4 \\ &= \overline{A}D(\overline{D} + BC) = \overline{A}BCD \end{aligned}$$

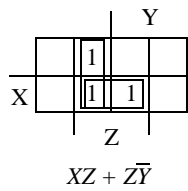

X	Y	Z	T1	T2	T3	T4	T5	F
0	0	0	1	1	1	1	1	0
0	0	1	1	1	1	0	0	1
0	1	0	1	1	0	1	1	0
0	1	1	1	1	0	1	1	0
1	0	0	1	0	1	1	1	0
1	0	1	1	0	1	1	0	1
1	1	0	0	1	1	1	1	0
1	1	1	0	1	1	0	0	1

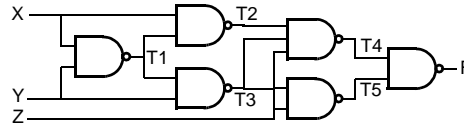
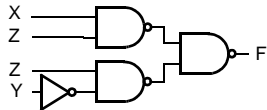

3-3.

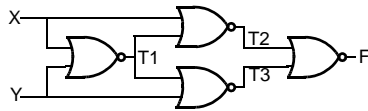

X	Y	T1	T2	T3	F
0	0	1	0	0	1
0	1	0	1	0	0
1	0	0	0	1	0
1	1	0	0	0	1

3-6.

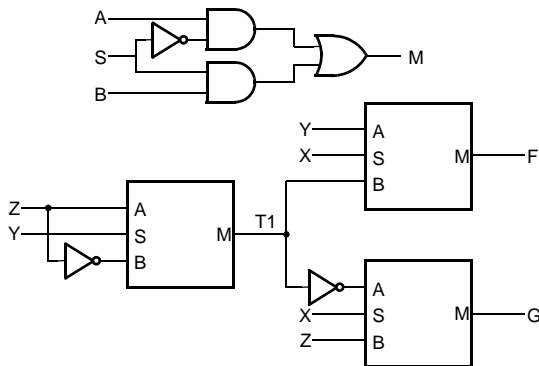

$$M = A\overline{S} + BS$$

$$T_1 = \overline{Z}Y + \overline{Z}Y$$

$$\begin{aligned} F &= Y\overline{X} + T_1X &= Y\overline{X} + X(\overline{Z}Y + \overline{Z}Y) \\ &= \overline{X}Y + X\overline{Y}Z + XY\overline{Z} \end{aligned}$$

$$\begin{aligned} G &= \overline{T}_1\overline{X} + ZX &= XZ + \overline{X}(\overline{Z} + Y)(\overline{Z} + \overline{Y}) \\ &= XZ + \overline{X}(YZ + \overline{Y}\overline{Z}) = XZ + \overline{X}YZ + \overline{X}\overline{Y}\overline{Z} \end{aligned}$$

Problem Solutions – Chapter 3

3-11.

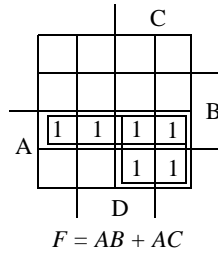

3-13.

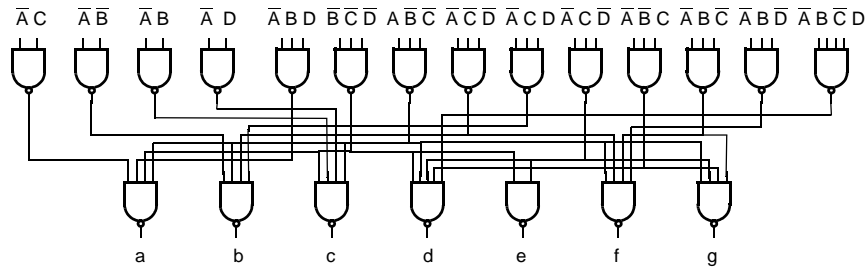

3-15.

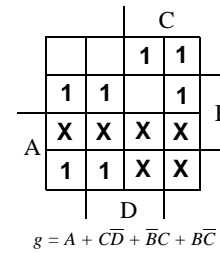
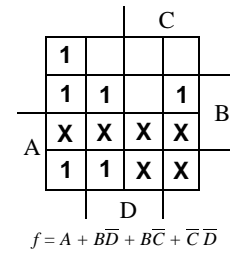
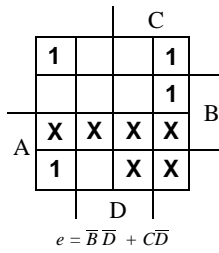
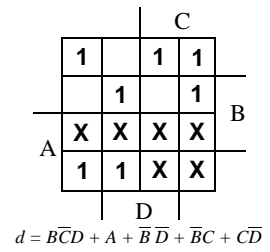
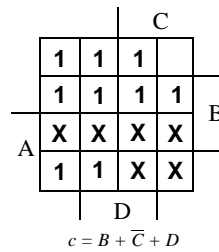
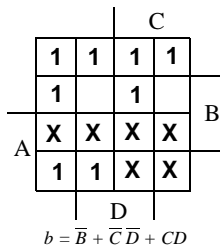
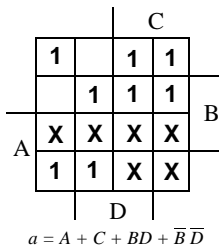

3-20.

D3	D2	D1	D0	A1	A0	V
0	0	0	0	X	X	0
X	X	X	1	0	0	1
X	X	1	0	0	1	1
X	1	0	0	1	0	1
1	0	0	0	1	1	1

$V = D0 + D1 + D2 + D3$

$A0 = D1 + \overline{D0} \overline{D2}$

$A1 = \overline{D0} \overline{D1}$

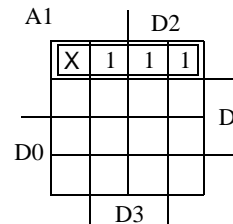
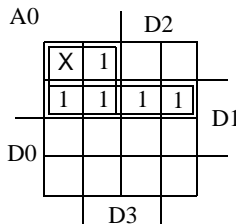

Problem Solutions – Chapter 3

3-25.

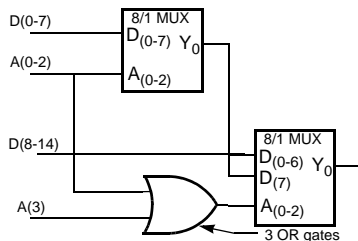

3-29.

A	B	C	D	F	
0	0	0	0	0	D
0	0	0	1	1	
0	0	1	0	0	
0	0	1	1	1	
0	1	0	0	1	\overline{CD}
0	1	0	1	0	
0	1	1	0	0	
0	1	1	1	0	

A	B	C	D	F	
1	0	0	0	0	CD
1	0	0	1	0	
1	0	1	0	0	
1	0	1	1	1	
1	1	0	0	1	+V
1	1	0	1	1	
1	1	1	0	1	
1	1	1	1	1	

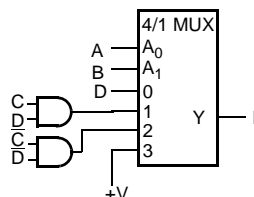

3-35.

$$C_1 = \overline{T_3 + T_2} = \overline{T_1 \overline{C_0} + T_2} = \overline{\overline{A_0 B_0 C_0} + \overline{A_0 + B_0}} = \overline{(\overline{A_0 + B_0}) \overline{C_0} + \overline{A_0 B_0}} = (A_0 B_0 + C_0)(A_0 + B_0)$$

$$C_1 = A_0 B_0 + A_0 C_0 + B_0 C_0$$

$$S_0 = C_0 \oplus T_4 = C_0 \oplus T_1 \overline{T_2} = C_0 \oplus \overline{A_0 B_0} (A_0 + B_0) = C_0 \oplus (\overline{A_0 + B_0}) (A_0 + B_0) = C_0 \oplus A_0 \overline{B_0} + \overline{A_0} B_0$$

$$S_0 = A_0 \oplus B_0 \oplus C_0$$

3-38.

1 0 0 1 1 0 0 0	1 0 0 1 1 0 0 1	1 0 1 0 1 1 0 0	0 0 0 0 0 0 0 0	1 0 0 0 0 0 0 0
0 1 1 0 0 1 1 1	0 1 1 0 0 1 1 0	0 1 0 1 0 0 1 1	1 1 1 1 1 1 1 1	0 1 1 1 1 1 1 1
0 1 1 0 1 0 0 0	0 1 1 0 0 1 1 1	0 1 0 1 0 1 0 0	0 0 0 0 0 0 0 0	1 0 0 0 0 0 0 0

3-41.

+43 = 0101011	43	0101011
-17 = 1101111	+(-17)	+ <u>1101111</u>
-43 = 1010101		10011010
+17 = 0010001	= 26	= 0011010
	-43	1010101
	+ <u>17</u>	+ <u>0010001</u>
	= -26	= 1100110

Problem Solutions – Chapter 3

3-45.

	S	A	B	C4	S3	S2	S1	S0
a)	0	0111	0110	0	1	1	0	1
b)	0	0100	0101	0	1	0	0	1
c)	1	1100	1010	1	0	0	1	0
d)	1	0101	1010	0	1	0	1	1
e)	1	0000	0010	0	1	1	1	0

3-49.

78430258 98989899 09580089 99999999

3-52.

BCD

	A	B	C	D	E	F	G	H
0	0	0	0	0	1	0	0	1
1	0	0	0	1	1	0	0	0
2	0	0	1	0	0	1	1	1
3	0	0	1	1	0	1	1	0
4	0	1	0	0	0	1	0	1
5	0	1	0	1	0	1	0	0
6	0	1	1	0	0	0	1	1
7	0	1	1	1	0	0	1	0
8	1	0	0	0	0	0	0	1
9	1	0	0	1	0	0	0	0

$$H = \bar{D}$$

$$G = C$$

$$F = \bar{B}C + B\bar{C}$$

$$E = \bar{A}\bar{B}\bar{C}$$

Gates: 8

Literals: 9

EXCESS-3

	A	B	C	D	E	F	G	H
0	0	0	1	1	1	1	0	0
1	0	1	0	0	1	0	1	1
2	0	1	0	1	1	0	1	0
3	0	1	1	0	1	0	0	1
4	0	1	1	1	1	0	0	0
5	1	0	0	0	0	1	1	1
6	1	0	0	1	0	1	1	0
7	1	0	1	0	0	1	0	1
8	1	0	1	1	0	1	0	0
9	1	1	0	0	0	0	1	1

$$H = \bar{D}$$

$$G = \bar{C}$$

$$F = \bar{B}$$

$$E = \bar{A}$$

Gates: 4

Literals: 4

3-55.

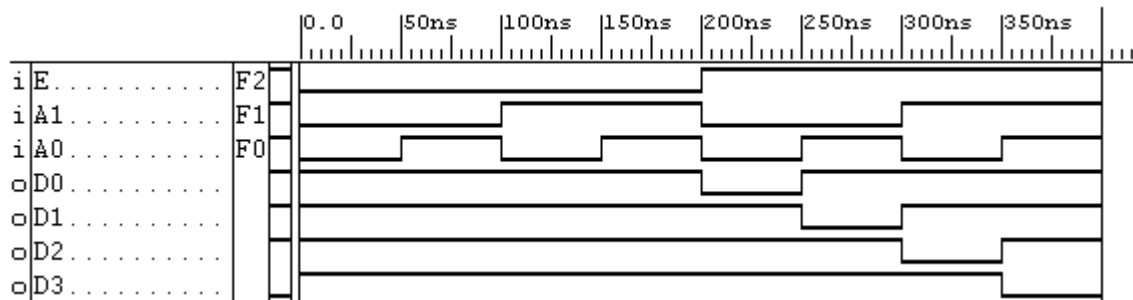

3-58.

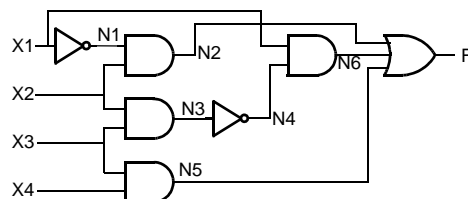

3-62.

From 3-2: $F = XZ + Z\bar{Y}$

Using Nand Gates:

```

...
signal T: std_logic_vector(0 to 2);
begin
  g0: NOT1 port map (Y, T(0));
  g1: NAND2 port map (X, Z, T(1));
  g2: NAND2 port map (Z, T(0), T(2));
  g3: NAND2 port map (T(1), T(2), F);
end

```

3-66.

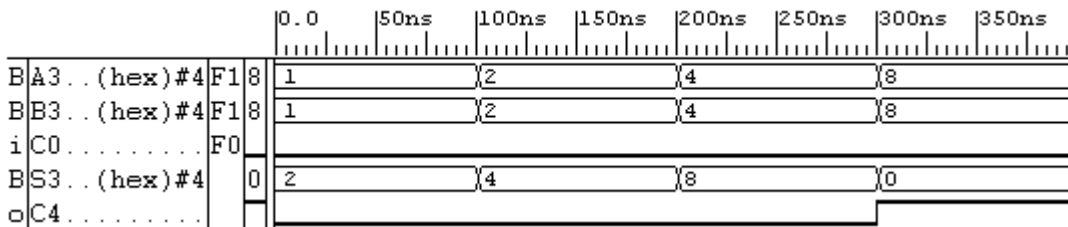
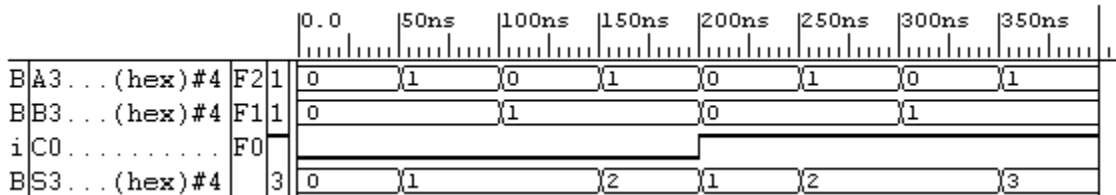

3-69.

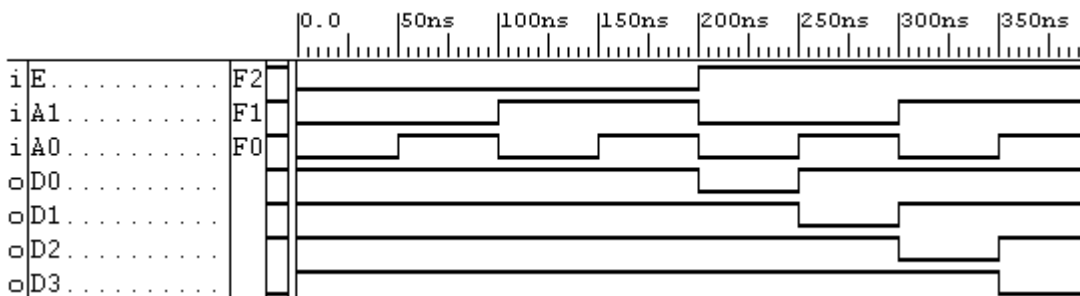

3-72.

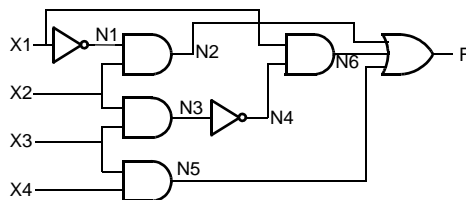

Problem Solutions – Chapter 3

3-76.

//Function F from problem 3-2 = $XZ + ZY$

```

module circuit_3_76(X, Y, Z, F);
    input X, Y, Z;
    output F;

    assign F = (X & Z) | (Z & ~Y);
endmodule
    
```

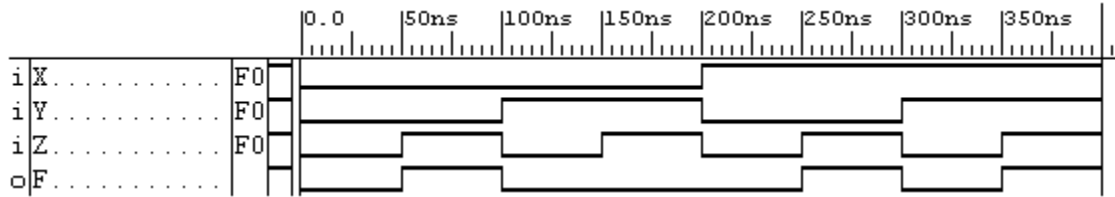

3-80.

