

King Fahd University of Petroleum & Minerals Computer Engineering Dept

**COE 202 – Fundamentals of Computer
Engineering**

Term 081

Dr. Ashraf S. Hasan Mahmoud

Rm 22-148-3

Ext. 1724

Email: ashraf@kfupm.edu.sa

11/18/2008

Dr. Ashraf S. Hasan Mahmoud

1

Karnaugh Map (K-Map)

- A tabular method to simplify function expressions – an alternative to algebraic manipulation
- Produces 2-level (sum of products or product of sums) implementation

11/18/2008

Dr. Ashraf S. Hasan Mahmoud

2

1-variable K-map

- Consider the function $F(X)$

$$F(X) = 0 \quad \begin{array}{c} x \quad 0 \quad 1 \\ (F \text{ is NOT dependent on } X) \quad \begin{array}{|c|c|} \hline 0 & 0 \\ \hline \end{array} \end{array}$$

$$F(X) = 1 \quad \begin{array}{c} x \quad 0 \quad 1 \\ (F \text{ is NOT dependent on } X) \quad \begin{array}{|c|c|} \hline 1 & 1 \\ \hline \end{array} \end{array}$$

$$F(X) = X \quad \begin{array}{c} x \quad 0 \quad 1 \\ \begin{array}{|c|c|} \hline 0 & 1 \\ \hline \end{array} \end{array}$$

$$F(X) = X' \quad \begin{array}{c} x \quad 0 \quad 1 \\ \begin{array}{|c|c|} \hline 1 & 0 \\ \hline \end{array} \end{array}$$

11/18/2008

Dr. Ashraf S. Hasan Mahmoud

3

2-variable K-map

- Consider the function $F(X,Y)$
- The general 2-variable K-map is as shown
- The map is formed by putting two 1-variable K-maps side by side

		Y=1	
		0	1
X	0	$X'Y'$ (m_0)	$X'Y$ (m_1)
	1	XY' (m_2)	XY (m_3)

- Examples:

		Y	
		0	1
X	0	0	0
	1	0	1

$$F(X,Y) = XY$$

11/18/2008

		Y	
		0	1
X	0	0	1
	1	1	1

$$F(X,Y) = X'Y + XY' + XY = X + Y$$

4

2-variable K-map – cont'd

- Neighbors sharing one literal:
 - $X'Y'$ (or m_0) and $X'Y$ (or m_1) → sharing the literal X'
 - $X'Y'$ (or m_0) and XY' (or m_2) → sharing the literal Y'
 - $X'Y$ (or m_1) and XY (or m_3) → sharing the literal Y
 - XY' (or m_2) and XY (or m_3) → sharing the literal X

If for example
 $F(X,Y) = m_0 + m_1 = X'Y' + X'Y$

Then once can simplify F as follows:

$$F(X,Y) = X'(Y' + Y)$$

$$= X' \rightarrow \text{the shared literal}$$

	Y	0	1
X	0	1	1
	1	0	0

11/18/2008

Dr. Ashraf S. Hasan Mahmoud

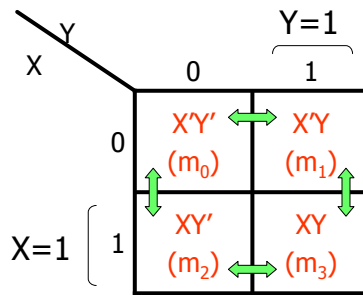

5

2-variable K-map – cont'd

- Example2: $F(X,Y) = \Sigma m(1,2,3)$

F can be simplified as in

$$F = X'Y + XY' + XY$$

$$= X'Y + XY + XY' + XY$$

$$= (X'+X)Y + X(Y'+Y)$$

$$= Y + X$$

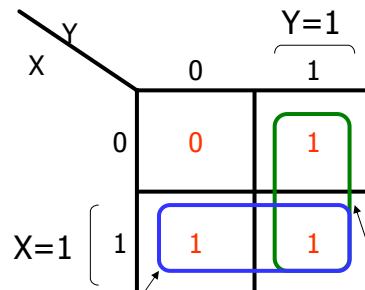

X – the common literal for this neighboring group

Y – the common literal for this neighboring group

11/18/2008

Dr. Ashraf S. Has

2-variable K-map – All Possible Squares

- 4 Groups each of one minterm
- 4 groups each of two minterms
- 1 group of 4 minterms

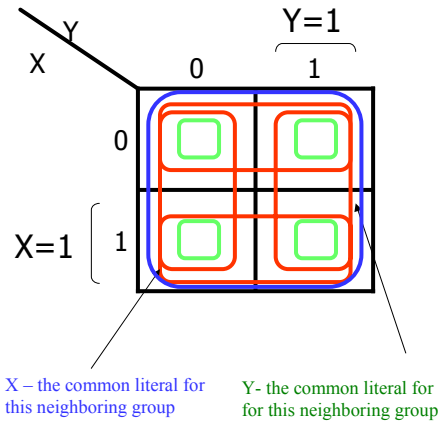

11/18/2008

Dr. Ashraf S. Has

3-variable K-map

- Consider the function $F(X,Y,Z)$
- The general 3-variable K-map is as shown
- The map is formed by putting two 2-variable K-maps side by side
- Note:
 - The minterms are ordered such that any two neighboring minterm differ only in one literal

- The K-Map (the numbering of the minterms) assumes X is the most significant variable and Z is the least significant variable

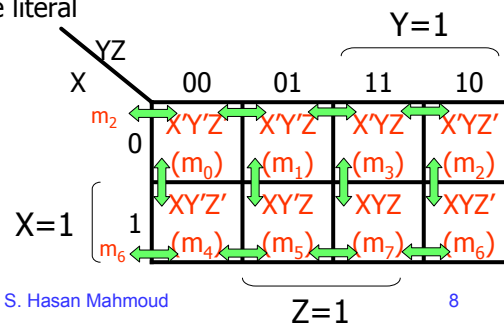

11/18/2008

Dr. Ashraf S. Hasan Mahmoud

8

3-variable K-map – cont'd

- Example $F(X,Y,Z) = m_5 + m_7$

Once can simplify as in

$$\begin{aligned} F &= m_5 + m_7 \\ &= XY'Z + XYZ \\ &= XZ(Y'+Y) \\ &= XZ \end{aligned}$$

Or once can use the K-map as shown

The common literals for this group is XZ (they differ in Y)

Therefore: $F(X,Y) = XZ$

		YZ			
		00	01	Y=1 11 10	
X	0				
	1		1	1	
		Z=1			

11/18/2008

Dr. Ashraf S. Hasan Mahmoud

9

3-variable K-map – cont'd

- Example $F(X,Y,Z) = \Sigma m(2,3,4,5)$

Once can simplify as in

$$\begin{aligned} F &= m_2 + m_3 + m_4 + m_5 \\ &= X'YZ' + X'YZ + XY'Z' + XY'Z \\ &= X'Y(Z'+Z) + XY'(Z'+Z) \\ &= X'Y + XY' \end{aligned}$$

Or one can use the K-map as shown

The common literals for the 1st group is $X'Y$ (they differ in Z), while the common literals for the 2nd group is XY' (they differ in Z)

Therefore: $F(X,Y) = X'Y + XY'$

		YZ			
		00	01	Y=1 11 10	
X	0			1	1
	1	1	1		
		Z=1			

11/18/2008

Dr. Ashraf S. Hasan Mahmoud

10

3-variable K-map – cont'd

- Example $F(X,Y,Z) = \Sigma m(0,2,4,5,6)$

Once can simplify as in

$$\begin{aligned}
 F &= m_0 + m_2 + m_4 + m_5 + m_6 \\
 &= X'Y'Z' + X'YZ' + XY'Z' + XY'Z + XYZ' \\
 &= X'Y'Z' + X'YZ' + XY'Z' + XY'Z + XY'Z \\
 &\quad + XYZ' \\
 &= Y'Z'(X' + X) + YZ'(X' + X) + \\
 &\quad XY'(Z' + Z) \\
 &= Z'(Y' + Y) + XY' \\
 &= Z' + XY'
 \end{aligned}$$

Or one can use the K-map as shown

The common literals for the 1st group is XY' (they differ in Z), while the common literal for the 2nd group is Z' (they differ in XY)

Therefore: $F(X,Y) = Z' + XY'$

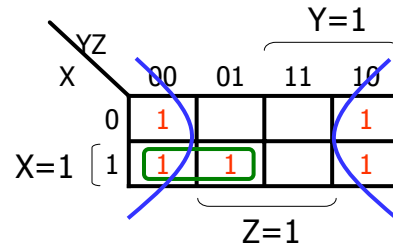

11/18/2008

Dr. Ashraf S. Hasan Mahmoud

11

3-variable K-map – All Possible Groups

- 8 groups each of 1 minterms
- 12 groups each of 2 minterms
- 4 groups each of 4 minterms
- 1 group of 8 minterms

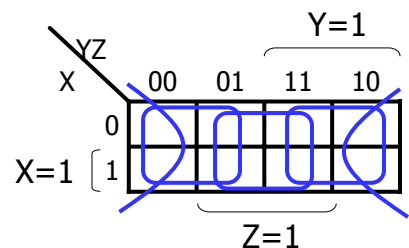
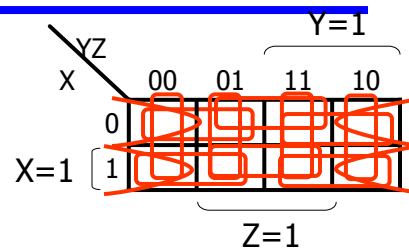

11/18/2008

Dr. Ashraf S. Hasan Mahmoud

12

Rules for Choosing Groups

- The groups SHOULD cover all minterms
- The groups SHOULD have minimum overlap
- The groups SHOULD be maximized in size (to reduce their number or product terms)

11/18/2008

Dr. Ashraf S. Hasan Mahmoud

13

Example

- Consider $F(X,Y,Z) = \Sigma m(1,3,4,5,6)$

Following the groups selection rules:

- there is no group of 8 or 4 that can be selected
- there are only groups of 2 that can be selected
- once can select the groups as shown (minimum no of groups)

Therefore $F(X,Y,Z) = X'Z + Y'Z + XZ'$

OR (See second K-Map)

$F(X,Y,Z) = X'Z + XZ' + XY'$

The simplest expression is NOT unique!

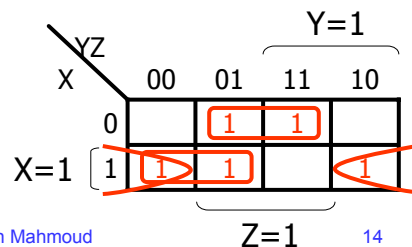
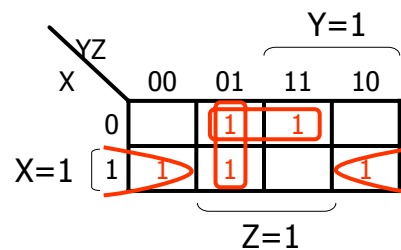

11/18/2008

Dr. Ashraf S. Hasan Mahmoud

14

Definitions

- Map manipulation: to minimize number of terms (i.e. simplify function and avoid redundant terms)
- Implicant:
 - A product term
 - Any valid square or group
- Prime Implicant: If you list all implicants, the removal of any literal does not lead to an implicant – the original implicant is a prime implicant
 - i.e. largest possible square
- Essential Prime Implicant: A prime implicant covering a minterm no other prime implicant does

11/18/2008

Dr. Ashraf S. Hasan Mahmoud

15

Example

- Consider $F(X,Y,Z) = \Sigma m(1,3,4,5,6)$

List all implicants, prime implicants and essential prime implicants

- Solution:
- Implicants: $XY'Z'$, XZ' , XY' , $XY'Z$, $X'Y'Z$, $Y'Z$, ...
- P.Is: XY' , XZ' , $Y'Z$, $X'Z$
- EPIs: $X'Z$, XZ'

The simplest expression is NOT unique!

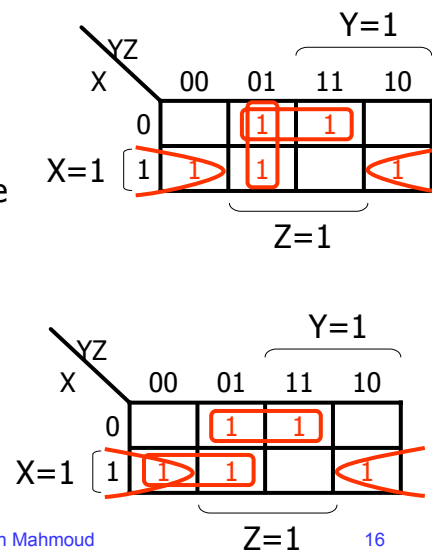

11/18/2008

Dr. Ashraf S. Hasan Mahmoud

16

4-variable K-map

- Consider the function $F(W,X,Y,Z)$
- The general 4-variable K-map is as shown
- The map is formed by putting two 3-variable K-maps on top of each other

- Note:

- The minterms are ordered such that any two neighboring minterm differ only in one literal
- The K-Map (the numbering of the minterms) assumes W is the most significant variable and Z is the least significant

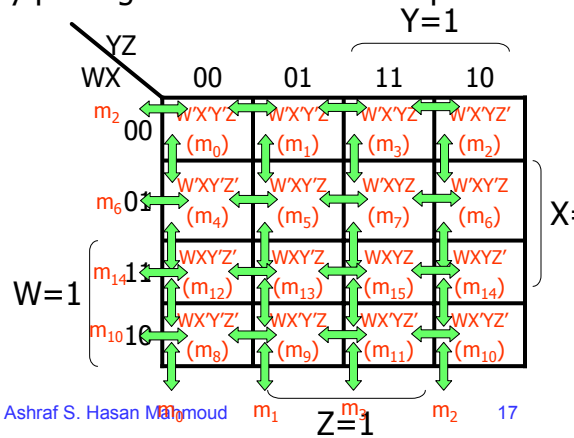

11/18/2008

Dr. Ashraf S. Hasan Mahmoud

m1 m2 m3 17

4-variable K-map – All Possible Groups

- 16 groups of one minterm
- 32 groups of two minterms
- ? groups of four minterms
- 8 groups of 8 minterms
- 1 group of 16 minterms

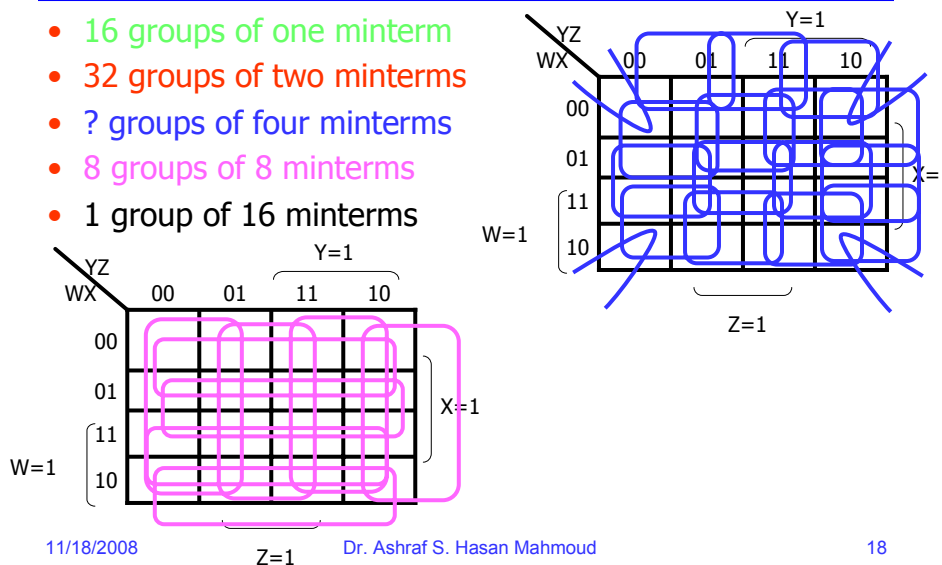

11/18/2008

Dr. Ashraf S. Hasan Mahmoud

18

4-variable K-map – Example

- Consider $F(W,X,Y,Z) = \Sigma m(0,1,2,4,5,6,8,9,12,13,14)$

$$F(W,X,Y,Z) = Y' + W'Z' + XZ'$$

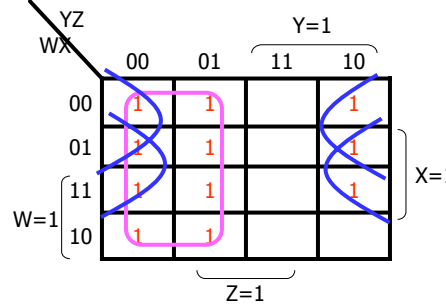

11/18/2008

Dr. Ashraf S. Hasan Mahmoud

19

Example

- Consider $F(A,B,C,D) = \Sigma m(1,3,4,5,6,7,12,13,14, 15)$
Find essential prime implicants?

- Solution:

$B, A'D$ are EPI

What is $F(A,B,C,D)$?

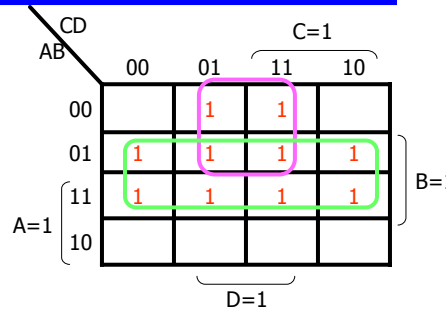

11/18/2008

Dr. Ashraf S. Hasan Mahmoud

20

Example

- Consider $F(W,X,Y,Z) = \Sigma m(0,1,5,10,11,12,13,15)$
Find all essential prime implicants?
Write all possible expressions for F?

- Solution:

$$\text{EPI} = A'B'C'D', BC'D, ABC', AB'C$$

$$F(A,B,C,D) = A'B'C'D' + BC'D + ABC' + AB'C + ACD \text{ (or ABD)}$$

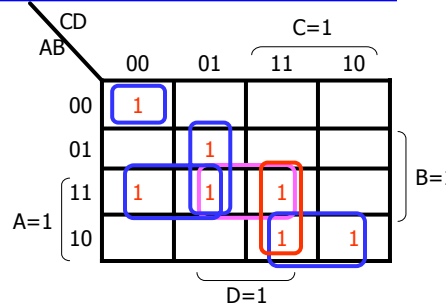

11/18/2008

Dr. Ashraf S. Hasan Mahmoud

21

Problem 2-19(a)

- Consider $F(W,X,Y,Z) = \Sigma m(0,2,5,7,8,10,12,13,14,15)$
Find all implicants, prime implicants, and essential prime implicants? Write all possible expressions for F?

- Solution:

Implicants: $W'X'Y'Z', W'X'Z', WX'Y'Z', WX'YZ', WX'Z', X'Z', \dots$

PIs: $WZ', XZ, X'Z', WX$

EPIs: $X'Z'$ (only PI covering $W'X'Y'Z'$),

XZ (only PI covering $W'XY'Z$ or $W'XYZ$)

$$F(W,X,Y,Z) = X'Z' + XZ + WX, \text{ OR} \\ = X'Z' + XZ + WZ'$$

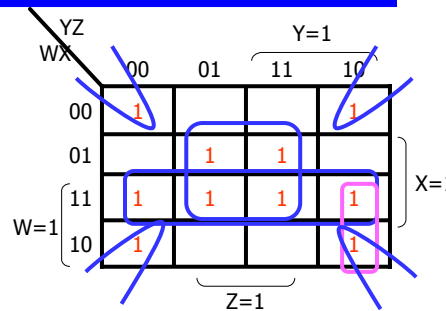

11/18/2008

Dr. Ashraf S. Hasan Mahmoud

22

Product of Sums Simplification - Example

- Consider $F(A,B,C,D) = \Sigma m(0,1,2,5,8,9,10)$
Write F in the simplified product of sums

- Solution:
Follow same rule as before but for the ZEROS

$$F' = AB + CD + BD'$$

Therefore,

$$F'' = F = (A'+B')(C'+D')(B'+D)$$

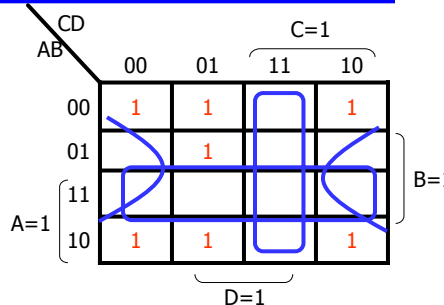

11/18/2008

Dr. Ashraf S. Hasan Mahmoud

23

Don't Care Conditions - Example

- Consider
 $F(A,B,C,D) = \Sigma m(1,3, 11, 15)$
 $d(A,B,C,D) = \Sigma m(0,2,5)$
Simplify F.

- Solution:
 $F = A'B' + CD$

Note – for the simplification we assumed $A'B'C'D'$ (m_0) = 1, and $A'B$ (m_2) = 1, while $A'BC'D$ (m_5) = 0

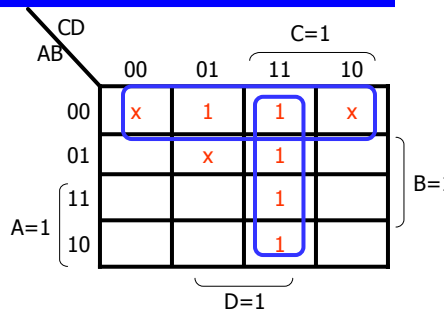

11/18/2008

Dr. Ashraf S. Hasan Mahmoud

24

More Gates: NAND - NOR

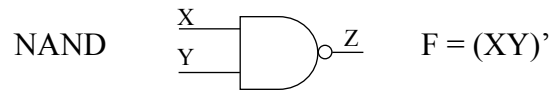

X	Y	Z=(XY)'
0	0	1
0	1	1
1	0	1
1	1	0

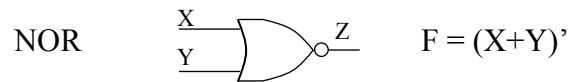

X	Y	Z=(X+Y)'
0	0	1
0	1	0
1	0	0
1	1	0

- Sometimes it is desirable to build circuits using NAND gates only or NOR gates only

11/18/2008

Dr. Ashraf S. Hasan Mahmoud

25

More Gates: XOR - XNOR



X	Y	Z=X⊕Y
0	0	0
0	1	1
1	0	1
1	1	0



X	Y	Z=(X⊕Y)'
0	0	1
0	1	0
1	0	0
1	1	1

11/18/2008

Dr. Ashraf S. Hasan Mahmoud

26

NAND Circuits

We have learned how to build any function using

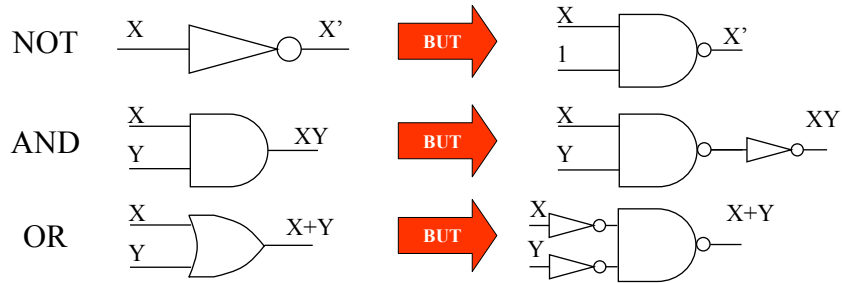

- Therefore, we can build all functions we learned so far using NAND gates ONLY
- NAND is a UNIVERSAL gate

11/18/2008

Dr. Ashraf S. Hasan Mahmoud

27

Graphic Symbols for NAND Gate

- Two equivalent graphic symbols or shapes for the SAME function

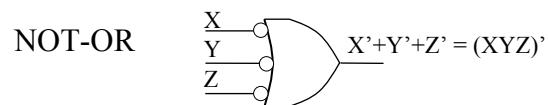
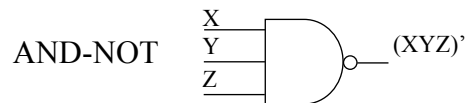

11/18/2008

Dr. Ashraf S. Hasan Mahmoud

28

Two Level Implementation

- We use the sum of products form
 - This results from K-map simplification or algebraic manipulation
- The AND gates – 1st level
- The OR gate – 2nd level
- Inverters to inputs of ANDs or output of OR are not counted as levels

11/18/2008

Dr. Ashraf S. Hasan Mahmoud

29

Two Level Implementation – cont'd

- Example: Consider $F = AB + CD$

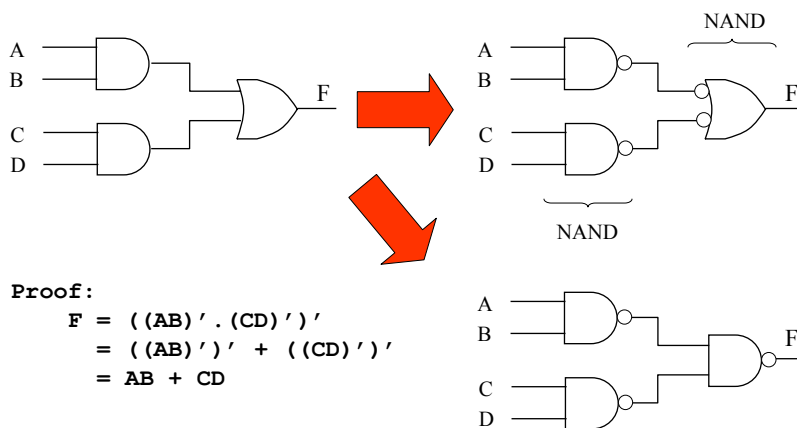

Proof:

$$\begin{aligned}
 F &= ((AB)' \cdot (CD)')' \\
 &= ((AB)')' + ((CD)')' \\
 &= AB + CD
 \end{aligned}$$

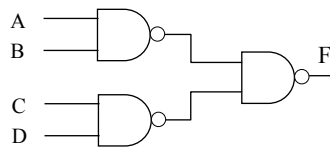

11/18/2008

Dr. Ashraf S. Hasan Mahmoud

30

Example

- Consider $F = \sum m(1,2,3,4,5,7)$ – Implement using NAND gates

		Y=1			
	YZ	00	01	11	10
X	0		1	1	1
X=1	1	1	1	1	
		Z=1			

$$F(X,Y) = Z + XY' + X'Y$$

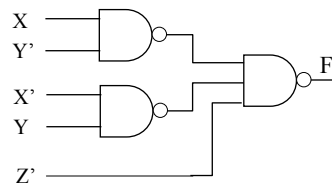
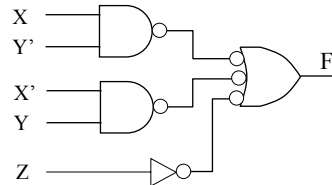

11/18/2008

Dr. Ashraf S. Hasan Mahmoud

31

Rules for 2-Level NAND Implementations

- Simplify the function and express it in sum-of-products form
- Draw a NAND gate for each product term (with 2 literals or more)
- Draw a single NAND gate at the 2nd level (in place of the OR gate)
- A term with single literal requires a NOT

What about multi-level circuits?

11/18/2008

Dr. Ashraf S. Hasan Mahmoud

32

Rules for Multi-Level NAND Implementations

- NOTE: the function is NOT in the standard form – WHY?
- Steps:
 - Draw a NAND gate for each AND gate
 - Draw a NAND gate (using the NOT-OR symbol) for each OR gate
 - Check paths – add inverters to make even number of bubbles

11/18/2008

Dr. Ashraf S. Hasan Mahmoud

33

Example (1): Rules for Multi-Level NAND Implementations

- Consider the function $F = A(CD+B)+BC'$

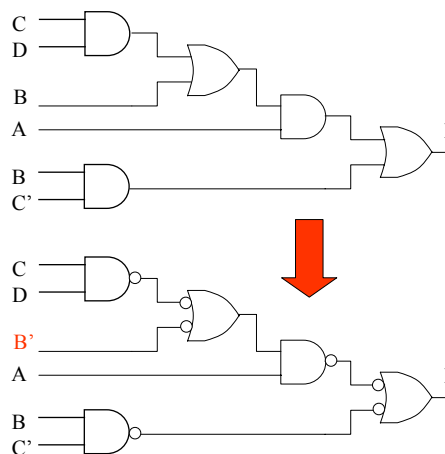

Note: an inverter is added to the path for the literal B

11/18/2008

Dr. Ashraf S. Hasan Mahmoud

34

Example (2): Rules for Multi-Level NAND Implementations

- Consider the function $F = (AB' + A'B)E(C + D')$

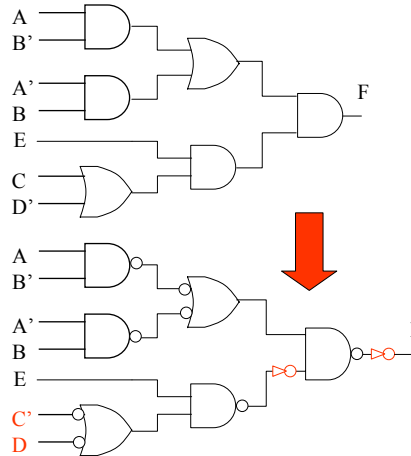

Note: an inverter is added to three paths

11/18/2008

Dr. Ashraf S. Hasan Mahmoud

35

NOR Circuits

We have learned how to build any function using

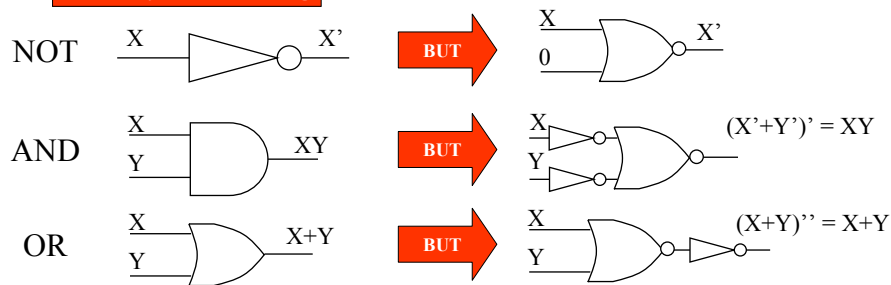

- Therefore, we can build all functions we learned so far using NOR gates ONLY
- NOR is a UNIVERSAL gate

11/18/2008

Dr. Ashraf S. Hasan Mahmoud

36

Graphic Symbols for NOR Gate

- Two equivalent graphic symbols or shapes for the SAME function

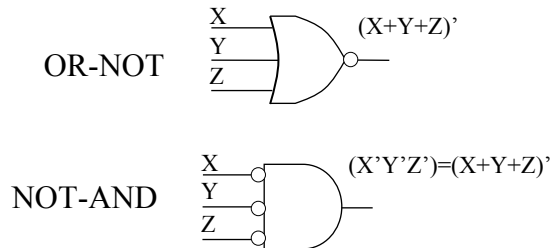

11/18/2008

Dr. Ashraf S. Hasan Mahmoud

37

Two Level Implementation - NOR

- Consider $F = (A+B)(C+D)E$

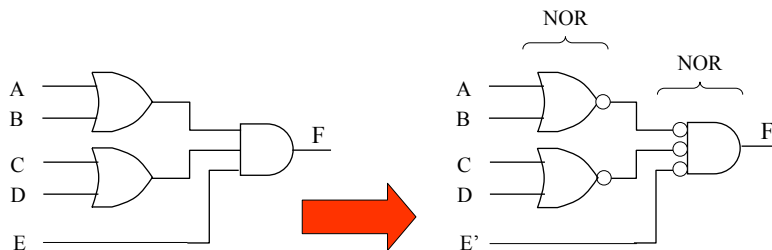

11/18/2008

Dr. Ashraf S. Hasan Mahmoud

38

Two Level Implementation - NOR

- We use the *product of sums* form
 - This results from K-map simplification or algebraic manipulation
 - Note to get product of sums we use the zeros – simplify and then complement the expression
- The OR gates – 1st level
- The AND gate – 2nd level
- Inverters to inputs of ORs or output of AND are not counted as levels

11/18/2008

Dr. Ashraf S. Hasan Mahmoud

39

Example

- Consider $F = \sum m(1,2,3,5,7)$ – Implement using NOR gates

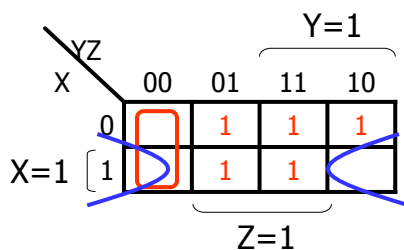

$$F'(X,Y) = Y'Z' + XZ', \text{ or}$$

$$F(X,Y) = (Y+Z)(X'+Z)$$

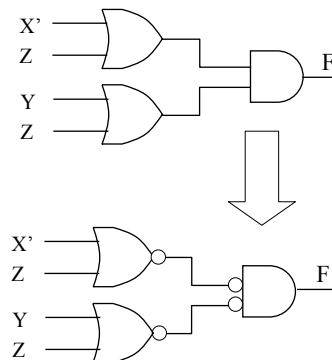

11/18/2008

Dr. Ashraf S. Hasan Mahmoud

40

Rules for 2-Level NOR Implementations

- Simplify the function and express it in product of sums form
- Draw a NOR gate (using OR-NOT symbol) for each sum term (with 2 literals or more)
- Draw a single NOR gate (using NOT-AND symbol) the 2nd level (in place of the AND gate)
- A term with single literal requires a NOT

What about multi-level circuits?

11/18/2008

Dr. Ashraf S. Hasan Mahmoud

41

Rules for Multi-Level NOR Implementations

- NOTE: the function is NOT in the standard form – WHY?
- Steps:
 - Draw a NOR (OR-NOT) gate for each OR gate
 - Draw a NOR (NOT-AND) gate for each AND gate
 - Check paths – add inverters to make even number of bubbles

11/18/2008

Dr. Ashraf S. Hasan Mahmoud

42

Example: Rules for Multi-Level NOR Implementations

- Consider the function $F = (AB' + A'B)E(C + D')$

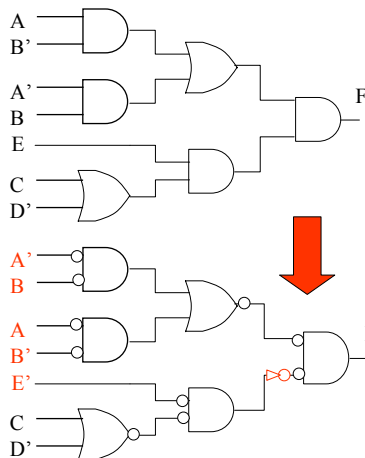

Note: an inverter is added to six paths

11/18/2008

Dr. Ashraf S. Hasan Mahmoud

43

Example (2): Rules for Multi-Level NOR Implementations

- Consider the function $F = (AB)' + C$

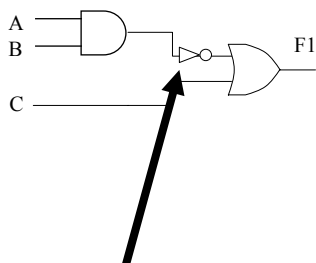

• Hence this bubble need not be complemented
• Only the ones added!!

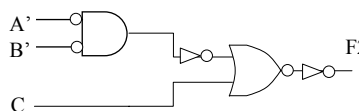

$$\begin{aligned}
 F2 &= ((A' B')' + C)' \\
 &= (AB)' + C \\
 &= F1
 \end{aligned}$$

11/18/2008

Dr. Ashraf S. Hasan Mahmoud

44

Example (3): Rules for Multi-Level NOR Implementations

- Consider the function $F = (A+B)'C$

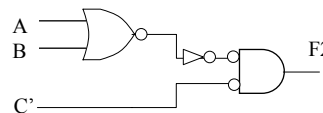
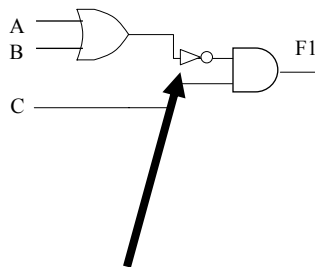

• Hence this bubble need not be complemented
 • Only the ones added!!

$$\begin{aligned}
 F2 &= (A+B)''C'' \\
 &= (A+B)'C' \\
 &= (A+B)'C \\
 &= F1
 \end{aligned}$$

11/18/2008

Dr. Ashraf S. Hasan Mahmoud

45

Example (4):

- Problem:** Simplify the following expression and implement using 2-level circuit with NAND gates. Assume both true and complement version of the input variables are available.

$$WX' + WXZ + W'Y'Z + W'XZ' + WXZ'$$

11/18/2008

Dr. Ashraf S. Hasan Mahmoud

46

Example (4): cont'd

- Solution:**

- Simplified 2-level implementation \rightarrow K-Map

$$F(W,X,Y,Z) = WX' + WXZ + W'Y'Z' + W'XY' + WXZ'$$

$$F(W,X,Y,Z) = W + XZ' + YZ'$$

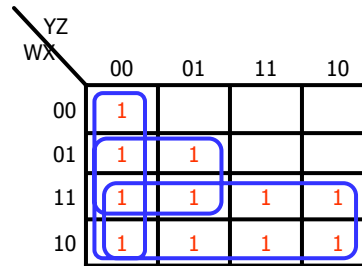
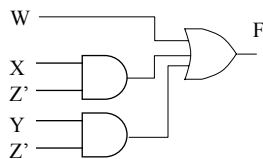

11/18/2008

Dr. Ashraf S. Hasan Mahmoud

47

Example (4): cont'd

- Solution:**

$$F(W,X,Y,Z) = W + XZ' + YZ'$$

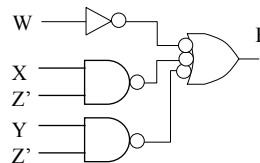
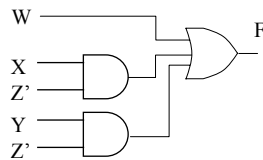

11/18/2008

Dr. Ashraf S. Hasan Mahmoud

48

XOR-XNOR Gates and Parity Checking

- **Required Material**
- **Refer to lesson2_7.pdf at:**
http://www.ccse.kfupm.edu.sa/~elrabaa/coe202/Lessons/Lesson2_7.pdf