

Diode

الوصلة الثنائية

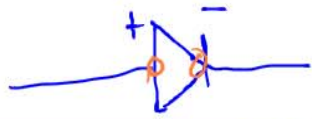

من الوجد

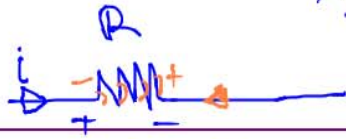
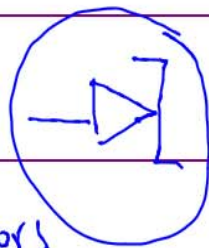
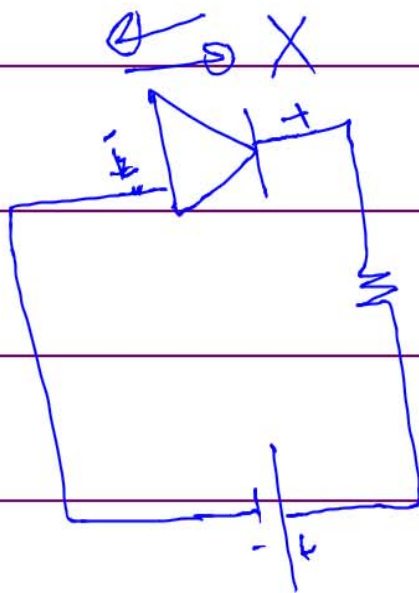
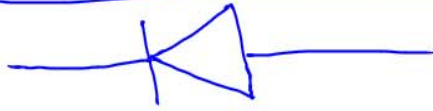
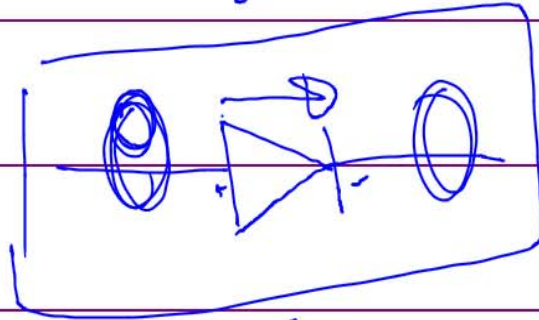

Zener diode

regulators

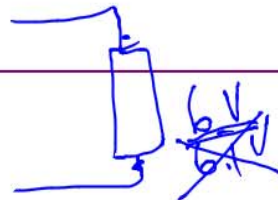

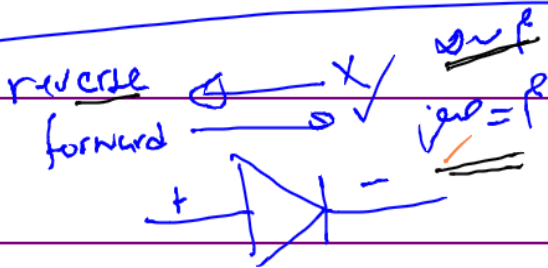
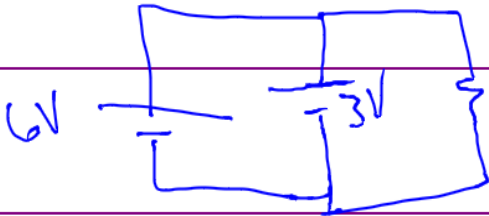
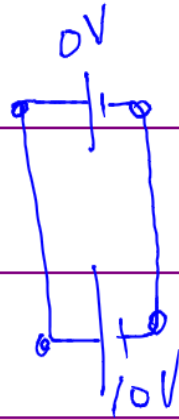
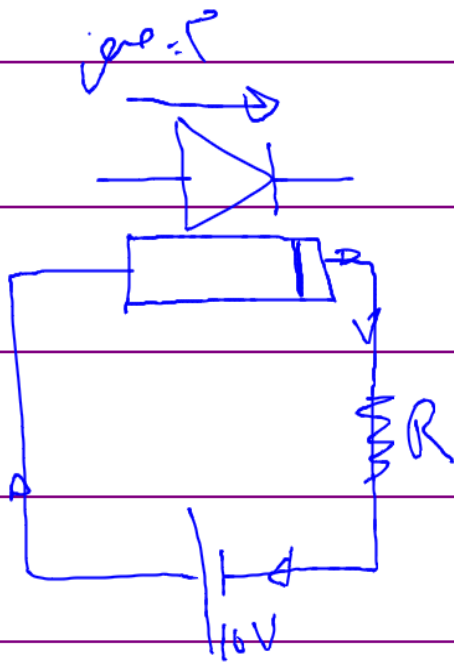

$$U_D = U_P$$

$$R_D = R_P = R$$

$$U_P = I$$

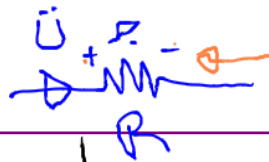
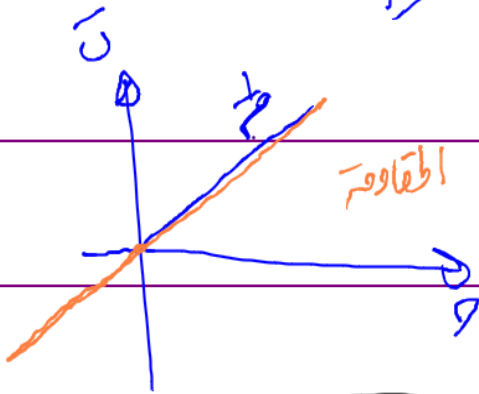

I-V
 Characteristics

$$\text{Volt/A} = \Omega$$

$$\frac{1}{R} = \sigma_0$$



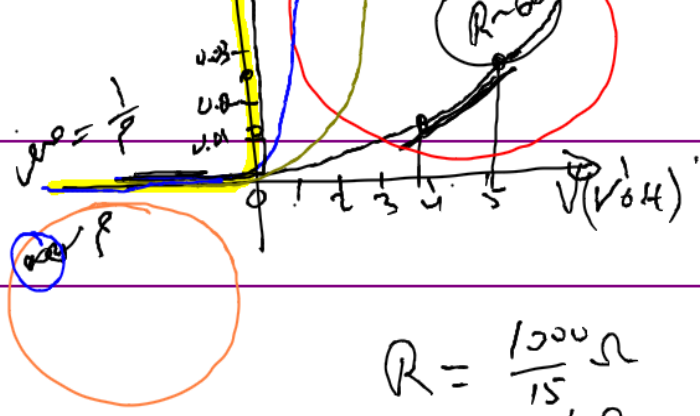

$$\frac{0.025 - 0.01}{5 - 4} \text{ A/V}$$

$$0.015 \frac{1}{\Omega}$$

$$R = \frac{1000}{15} \Omega \approx 66.6 \Omega$$

$$\left(\frac{1}{R}\right) = \frac{15}{1000} \frac{1}{\Omega}$$

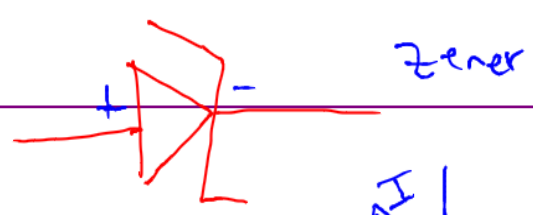
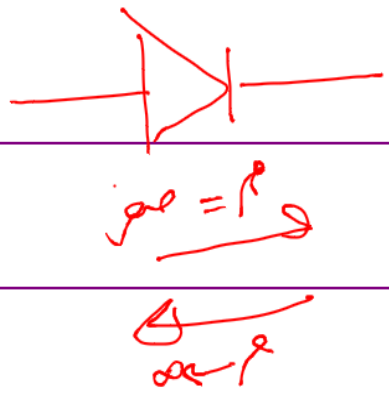
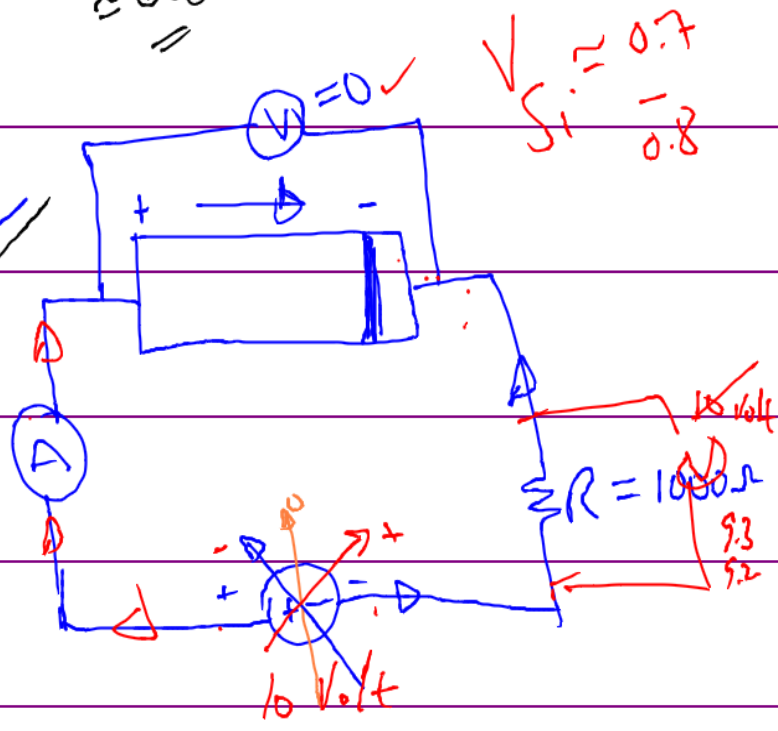
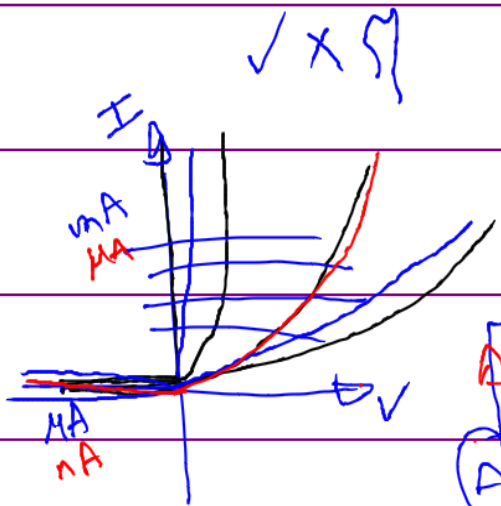

Regulator
series limiting resistor



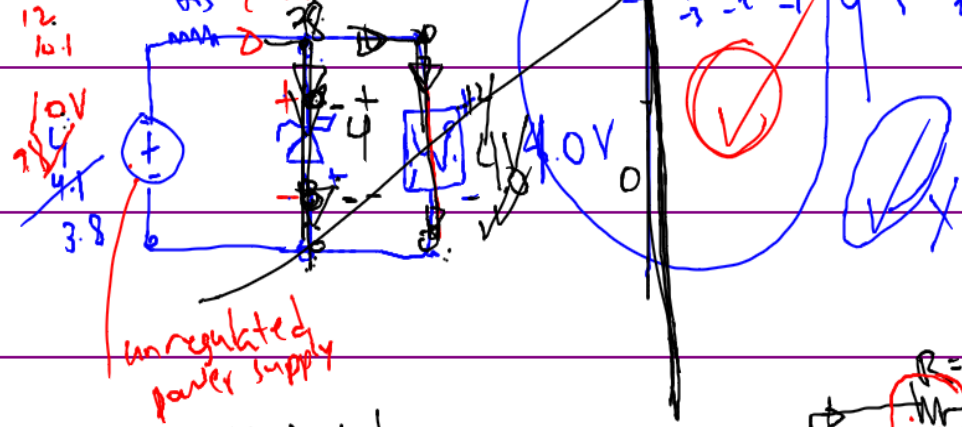

assume ideal diode

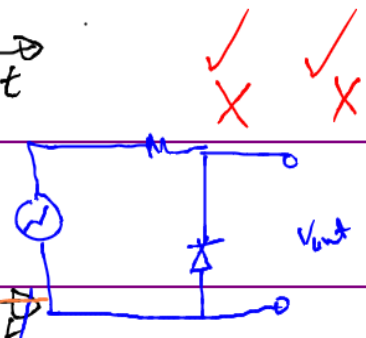
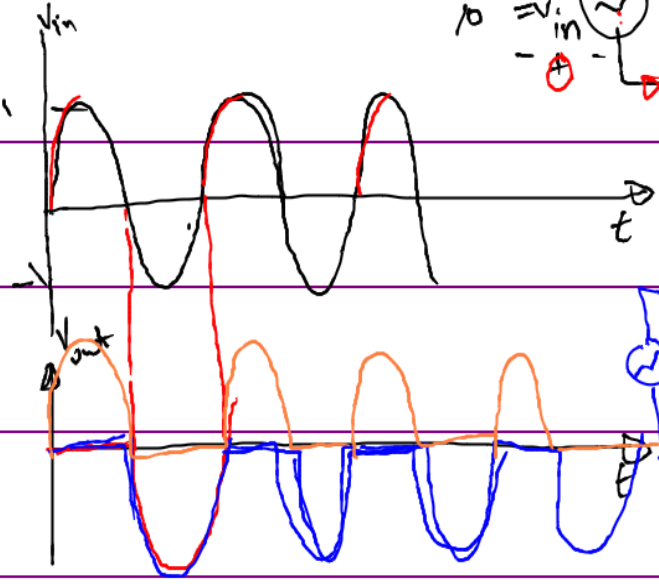
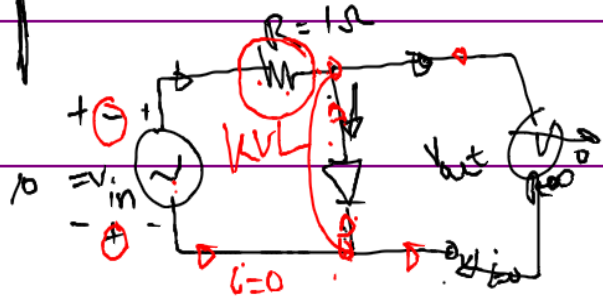

$\frac{1}{1000}$

0.1%

كيف يعمل الريود

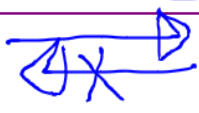
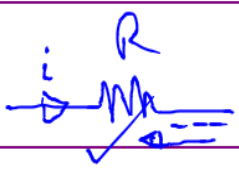
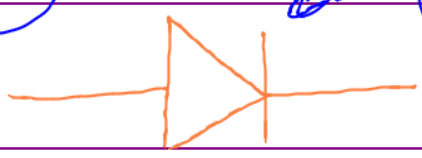

فزيلا
آكالة
الهلبة

2nd LDE band pass filter

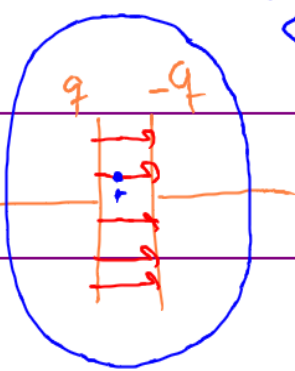

✓ ✗

Fourier components

HTW: Diode

