

STUDENT NUMBER:

NAME:

SECTION NUMBER:

KING FAHD UNIVERSITY OF PETROLEUM AND MINERALS

COURSE: PH102

EXAM: PH102 2ND MAJOR EXAM - 002

TEST CODE NUMBER: XXX

INSTRUCTIONS:

1. PRINT YOUR STUDENT NUMBER, NAME, AND SECTION NUMBER ON THE EXAM.
2. PRINT YOUR STUDENT NUMBER, SECTION NUMBER, AND YOUR NAME ON THE EXAM ANSWER FORM. PRINT THE TEST CODE NUMBER, OR CHECK IT IF IT HAS ALREADY BEEN PRINTED ON YOUR ANSWER FORM.
3. CODE YOUR STUDENT NUMBER AND SECTION NUMBER ON THE EXAM ANSWER FORM. CODE THE TEST CODE NUMBER, OR CHECK IT IF IT IS ALREADY CODED.
4. CODE YOUR ANSWERS ON THE EXAM ANSWER FORM. YOU MUST NOT GIVE MORE THAN ONE ANSWER PER QUESTION.
5. RETURN THE EXAM AND ANSWER FORM TO THE INSTRUCTOR WHEN YOU HAVE FINISHED.

 QUESTION NO: 1

Two uniformly charged, concentric and hollow, spheres have radii r and $1.5r$. The charge of the inner sphere is $q/2$ and that on the outer sphere is $3q/2$. Find the electric field at a distance $2.0r$ from the center of the spheres.

- A. $0.25kq/(r^2)$.
- B. $0.13kq/(r^2)$.
- C. $0.5kq/(r^2)$.
- D. $0.35kq/(r^2)$.
- E. Zero.

 QUESTION NO: 2

An infinitely long line has a charge density of 7.6 nano-C/m. Calculate the electric flux through a spherical surface of radius $R = 7.7$ cm whose center, C , lies on the line charge as shown in Figure 3.

- A. $610 (Nm^2)/C$.
- B. Zero.
- C. $415 (Nm^2)/C$.
- D. $92.0 (Nm^2)/C$.
- E. $132 (Nm^2)/C$.

 QUESTION NO: 3

A charged particle has a mass of 2.0×10^{-4} kg. If it is held stationary by a downward 300 N/C electric field, the charge of the particle is:

- A. -6.5×10^{-6} C.
- B. 6.5×10^{-6} C.
- C. -1.5×10^{-6} C.
- D. -3.0×10^{-6} C.
- E. 1.5×10^{-6} C.

 QUESTION NO: 4

Two neutral metal sphere are separated by 0.3 km. How much electric charge must be transferred from one sphere to the other so that their electrical attraction is 10^{**3} N?

- A. 0.4 C.
 B. 0.6 C.
 C. 0.9 C.
 D. 0.1 C.
 E. 0.2 C.

 QUESTION NO: 5

Not required for second major 032

A parallel-plate capacitor, of capacitance $1.0 \times 10^{**(-9)}$ F, is charged by a battery to a potential difference of 12.0 volts. The charging battery is then disconnected and oil with dielectric constant = 4.0 fills the inside space between the plates. The resulting potential difference, in volts, between the plates is:

- A. 12.
 B. 48.
 C. 3.
 D. $1.0 \times 10^{**(-9)}$.
 E. $3.0 \times 10^{**(-9)}$.

 QUESTION NO: 6

Not required for second major 032

If V_{ab} is equal to 50 V, find the charge stored and the potential difference across the 25 micro-F capacitor shown in Figure 5.

- A. 300 micro-C and 20 V.
 B. 250 micro-C and 10 V.
 C. 600 micro-C and 20 V.
 D. 600 micro-C and 10 V.
 E. 250 micro-C and 40 V.

QUESTION NO: 7

An ideal engine absorbs heat at 527 degrees Celsius and rejects heat at 127 degrees Celsius. If it has to produce useful mechanical work at the rate of 750 Watts, it must absorb heat at the rate of:

- A. 1500 Watts.
- B. 750 Watts.
- C. 375 Watts.
- D. 2250 Watts.
- E. 527 Watts.

QUESTION NO: 8

A heat engine has a monatomic gas as the working substance and its operating cycle is shown by the P-V diagram in Figure 1. In one cycle, 18.2 kJ of heat energy is absorbed by the engine. Find the efficiency of the heat engine.

- A. 0.44
- B. 0.31
- C. 0.22
- D. 0.25
- E. 0.55

QUESTION NO: 9

What is the change in entropy of 200-g of water as its temperature increases from 0 degrees Celsius to 50 degrees Celsius. [For water: the specific heat = 4.19 kJ/(kg.K) and the latent heat of fusion = 333 kJ/kg.]

- A. 4.19×10^3 J/K.
- B. 3.35×10^3 J/K.
- C. 1.41×10^2 J/K.
- D. 0.35×10^3 J/K.
- E. 2.55×10^3 J/K.

 QUESTION NO: 10

Not required for second major 032

The equivalent capacitance between points a and b in the combination of capacitors in figure 6 is:

- A. $1.0 \times 10^{(-6)}$ F.
- B. $2.0 \times 10^{(-6)}$ F.
- C. $1.5 \times 10^{(-6)}$ F.
- D. $0.5 \times 10^{(-6)}$ F.
- E. $3.0 \times 10^{(-6)}$ F.

 QUESTION NO: 11

A negative charge is placed at the center of a square. Each corner of the square has a fixed charge of $1.00 \times 10^{(-6)}$ C. If the resulting force acting on each charge is zero, the magnitude of the negative charge is:

- A. $0.77 \times 10^{(-6)}$ C.
- B. $0.96 \times 10^{(-6)}$ C.
- C. $0.69 \times 10^{(-6)}$ C.
- D. $6.92 \times 10^{(-6)}$ C.
- E. $9.60 \times 10^{(-6)}$ C.

 QUESTION NO: 12

In figure 2, four charges are fixed at the corners of a square whose sides are of length d. The work done by an external agent to bring a fifth charge, Q, from infinity to the center of the square is:

- A. $-1.4kqQ/d$.
- B. $2.8kqQ/d$.
- C. $3.4kqQ/d$.
- D. $-2.8kqQ/d$.
- E. $1.4kqQ/d$.

 QUESTION NO: 13

Not required for second major 032

If 110 Volts is applied to a wire, the current density is $1.5 \times 10^6 \text{ A/m}^2$. If the resistivity of the wire is $48.2 \times 10^{-8} \text{ Ohm.m}$, the length of the wire is:

- A. 19 m.
- B. 38 m.
- C. 152 m.
- D. 254 m.
- E. 76 m.

 QUESTION NO: 14

A point charge of 4.0 nano-C is located at a point having coordinates (30.0 cm, 40.0 cm). At what point will the electric field be 72 N/C and pointing in the negative y-direction?

- A. (10.0, -89.9) cm
- B. (30.0, 70.7) cm
- C. (30.0, -49.9) cm
- D. (30.0, -30.7) cm
- E. (30.0, 49.9) cm

 QUESTION NO: 15

Not required for second major 032

An electric dipole consists of a positive charge of magnitude $6.0 \times 10^{-6} \text{ C}$ at the origin and a negative charge of magnitude $6.0 \times 10^{-6} \text{ C}$ on the x-axis at $x = 3.0 \times 10^{-3} \text{ m}$. Its dipole moment is:

- A. $1.8 \times 10^{-8} \text{ C.m}$, perpendicular to the x-axis.
- B. $1.8 \times 10^{-8} \text{ C.m}$, in the positive x direction.
- C. $1.8 \times 10^{-8} \text{ C.m}$, in the negative x direction.
- D. Zero because the net charge is Zero.
- E. $3.6 \times 10^{-8} \text{ C.m}$, in the negative x direction.

 QUESTION NO: 16

Not required for second major 032

At what temperature would the resistance of a conductor be double its resistance at 30 degrees Celsius?
 [The temperature coefficient of resistivity of the conductor is $2.0 \times 10^{(-2)} \text{ K}^{-1}$]

- A. 80 degrees Celsius.
- B. -20 degrees Celsius.
- C. 20 degrees Celsius.
- D. 50 degrees Celsius.
- E. 60 degrees Celsius.

 QUESTION NO: 17

A charge q is located at the center of a circle with a large radius R , see figure 4. Another charge Q is located on the circumference of the circle at the x -axis. What is the work, in Joules, needed to move Q from its location to point F , on the x -axis, along the circumference?

- A. $2kqQ/R$.
- B. Zero.
- C. kqQ/R .
- D. $kqQ/(2R)$.
- E. $kq/(2R)$.

 QUESTION NO: 18

Fig. 7 shows two parallel plates, infinite and non-conducting, with surface charge densities of $8.9 \times 10^{(-4)} \text{ C/m}^2$ and $-8.9 \times 10^{(-4)} \text{ C/m}^2$. B, a ball with negligible mass, carries a positive charge of $6.0 \times 10^{(-8)} \text{ C}$ and is attached to point A with a non-conducting string of length 10 cm. At equilibrium, the tension in the string is:

- A. 0.3 N.
- B. 1.5 N.
- C. 6.0 N.
- D. 3.0 N.
- E. Zero.

 QUESTION NO: 19

A particle [$m = 8.0 \times 10^{-9}$ kg, $q = +6.0 \times 10^{-9}$ C] has a speed of 80 m/s at point A and moves to point B where the potential is 2.0×10^3 V greater than at point A. What is the particle's kinetic energy at point B? (Assume that only electric forces act on the particle during its motion.)

- A. 40×10^{-6} J.
- B. 14×10^{-6} J.
- C. 28×10^{-6} J.
- D. 10×10^{-6} J.
- E. 38×10^{-6} J.

 QUESTION NO: 20

Which of the following statements are CORRECT:

1. Electric charge is quantized.
2. The potential at the center of a charged conductor is zero.
->
3. If $E = 0$ at a point P then V must be zero at P.
4. The electric field inside a charged conductor is zero.
->
5. If $V = 0$ at a point P then E must be zero at P.

- A. 1, 2 and 3.
- B. 1, 2, and 5.
- C. 1 and 4.
- D. 3 and 5.
- E. 2 and 4.

Physics 102
Formula Sheet for 2nd Major Exam
Second Semester 2000-2001 (Term 002)

$$Q = mc\Delta T, \quad Q = mL$$

$$Q = nc_p \Delta T, \quad Q = nc_v \Delta T$$

$$W = Q_h - Q_c$$

$$\varepsilon = \frac{W}{Q_h} = 1 - \frac{Q_c}{Q_h}$$

$$K = \frac{Q_c}{W}$$

$$\frac{Q_c}{Q_h} = \frac{T_c}{T_h}, \quad \Delta S = \int \frac{dQ_r}{T}$$

$$F = \frac{kq_1q_2}{r^2}, \quad \Phi = \int_{\text{Surface}} \vec{E} \cdot d\vec{A}$$

$$E = \sigma / 2\varepsilon_0, \quad E = \sigma / \varepsilon_0$$

$$E = \frac{kQ}{r^2}, \quad E = \frac{kQ}{R^3} r, \quad E = \frac{2k\lambda}{r}$$

$$U = -\vec{P} \cdot \vec{E}$$

$$\vec{\tau} = \vec{P} \wedge \vec{E}$$

$$\Phi_c = \oint \vec{E} \cdot d\vec{A} = \frac{q_{\text{in}}}{\varepsilon_0}$$

$$E_x = -\frac{\partial V}{\partial x}, \quad E_y = -\frac{\partial V}{\partial y}, \quad E_z = -\frac{\partial V}{\partial z}$$

$$\Delta V = V_B - V_A = - \int_A^B \vec{E} \cdot d\vec{S} = \frac{\Delta U}{q_0}$$

$$V = \frac{kQ}{r}$$

$$U = \frac{kq_1q_2}{r_{12}}$$

$$C = \frac{Q}{V}, \quad C = \kappa C_0$$

$$I = nq v_d A = JA, \quad J = \sigma E$$

$$P = IV, \quad U = \frac{1}{2} CV^2$$

$$I = \frac{dQ}{dt}; \quad I = \frac{\Delta Q}{\Delta t}$$

$$R = \frac{V}{I} = \rho \frac{L}{A}$$

$$\rho = \rho_0 [1 + \alpha (T - T_0)]$$

$$v = v_0 + at$$

$$x - x_0 = v_0 t + \frac{1}{2} a t^2$$

$$v^2 = v_0^2 + 2 a (x - x_0)$$

Constants:

$$k = 9.0 \times 10^9 \text{ N.m}^2/\text{C}^2$$

$$\varepsilon_0 = 8.85 \times 10^{-12} \text{ C}^2/\text{N.m}^2$$

$$e = 1.6 \times 10^{-19} \text{ C}$$

$$m_e = 9.11 \times 10^{-31} \text{ kg}$$

$$m_p = 1.67 \times 10^{-27} \text{ kg}$$

$$k_B = 1.38 \times 10^{-23} \text{ J/K}$$

$$N_A = 6.022 \times 10^{23} \text{ molecules/mole}$$

$$R = 8.314 \text{ J/mol.K}$$

$$1 \text{ atm} = 1.013 \times 10^5 \text{ N/m}^2$$

$$g = 9.8 \text{ m/s}^2$$

$$\text{micro} = 10^{-6}$$

$$\text{nano} = 10^{-9}$$

$$\text{pico} = 10^{-12}$$

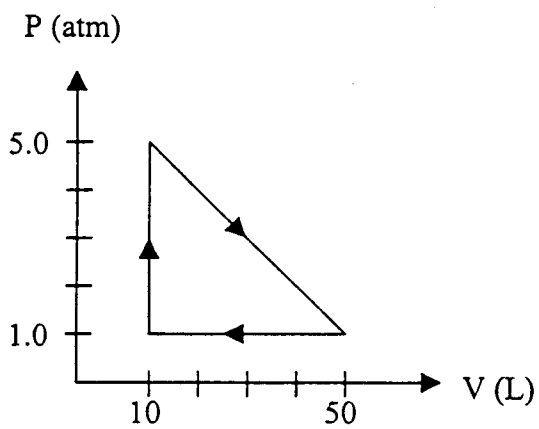

FIGURE 1

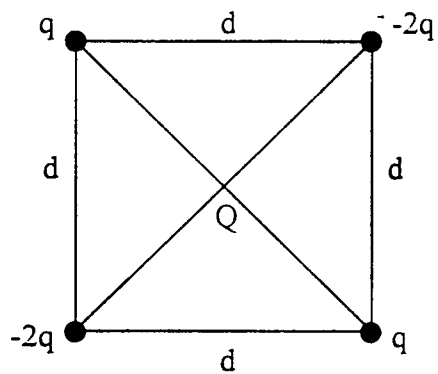

FIGURE 2

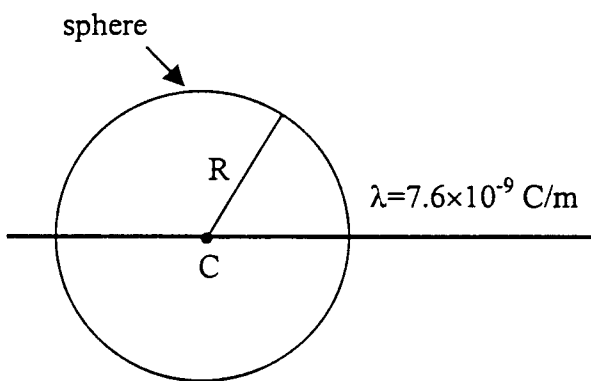

FIGURE 3

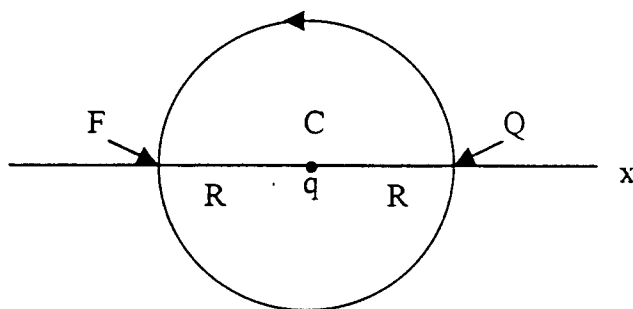

FIGURE 4

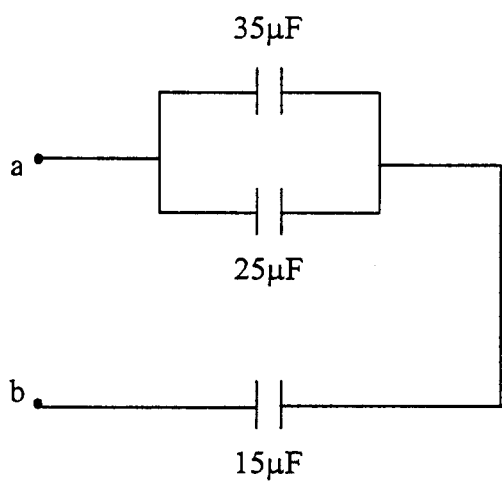

FIGURE 5

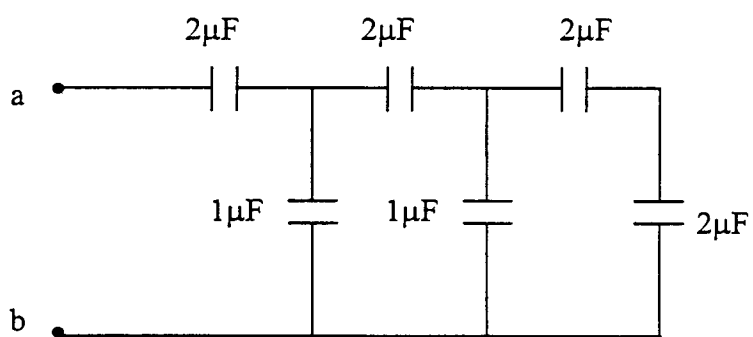

FIGURE 6

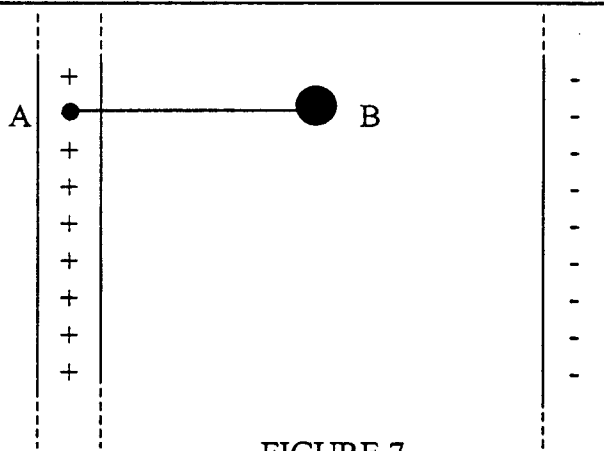

FIGURE 7

Apr 26, 02

Phys 102 - major 2 - 002 - P1

Q1

$$E = \frac{k \left(\frac{q}{2} + \frac{3}{2}q \right)}{(2r)^2}$$

$$= \frac{1}{2} \frac{kq}{r^2}$$

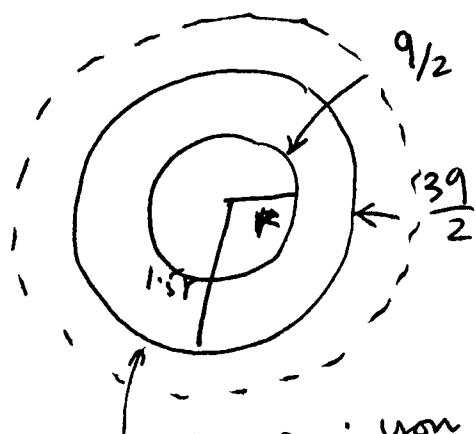

Shell theorem: you can ~~three~~ treat the two shells as point charges at the center

Q2 flux through the closed surface = $\frac{\text{charged inside the surface}}{\epsilon_0}$

$$= \frac{\lambda(2R)}{\epsilon_0} = \frac{(7.6 \times 10^{-9})(2 \cdot 0.077)}{8.85 \times 10^{-12}}$$

$$= 132 \text{ Nm}^2/\text{C}$$

Q3

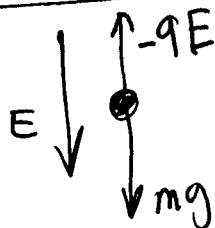

Newton's Second law

$$-qE = mg$$

$$q = -\frac{(2 \times 10^{-4})(9.8)}{300} = -6.5 \times 10^{-6} \text{ C}$$

Q4

$$F = k \frac{q^2}{r^2}$$

$$q = \sqrt{\frac{Fr^2}{k}} = \sqrt{\frac{10^3}{8.99 \times 10^9}} \cdot 0.3 \times 10^3 = 0.1 \text{ C}$$



Q5

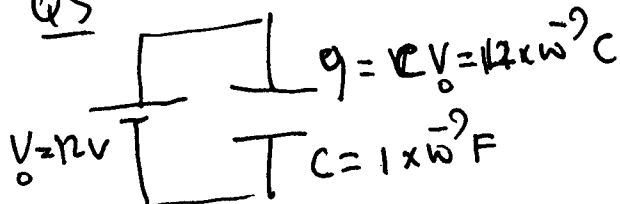

Since the battery is disconnected charge does not change

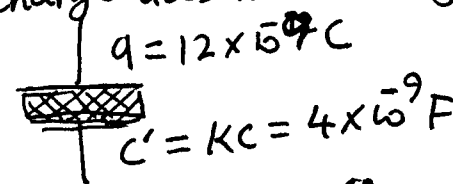

$$V' = \frac{q}{C'} = \frac{12 \times 10^{-9}}{4 \times 10^{-9}} = 3 \text{ V}$$

Apr 26, 02

Phys 102 - major 2 - 002 - p2

Q6

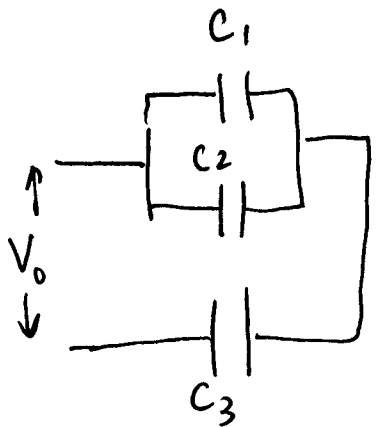

$$C_{12} = C_1 + C_2 = 60 \mu\text{F}$$

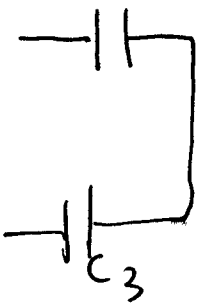

series \rightarrow

$$C_{123} = \frac{C_{12}C_3}{C_{12} + C_3} = 12 \mu\text{F}$$

$$Q_{123} = C_{123} V_0 = (12 \mu)(150) = 600 \mu\text{C}$$

$$Q_2 = C_2 V_2 = (25 \mu)(10) = 250 \mu\text{F}$$

$$V_{12} = \frac{Q_{12}}{C_{12}} = \frac{600 \mu\text{C}}{60 \mu} = 10 \text{ V}$$

C_1 and C_2 are connected in parallel

Since C_2 and C_3 are connected in series

$$V_2 = 10 \text{ V}$$

$$Q_2 = 250 \mu\text{F}$$

Q7

$$\epsilon = 1 - \frac{T_L}{T_H} = 1 - \frac{127 + 273}{527 + 273} = 0.50$$

$$\epsilon = \frac{W}{Q_H} = \frac{\Delta W / \Delta t}{\Delta Q_H / \Delta t} \Rightarrow \frac{\Delta Q_H}{\Delta t} = \frac{\Delta W / \Delta t}{\epsilon} = \frac{750}{0.5} = 1500 \text{ W}$$

Q8

$$\epsilon = \frac{W}{Q_H} = \frac{\frac{1}{2}(5-1)(50-10) \text{ atm} \cdot \text{L}}{80 \text{ atm} \cdot \text{L} \left(\frac{1.01 \times 10^5 \text{ Pa}}{\text{atm}} \right) \left(\frac{10^{-3} \text{ m}^3}{\text{L}} \right)} = \frac{10 \text{ atm} \cdot \text{L}}{18.2 \times 10^3 \text{ J}} = 0.44$$

Work = area of the closed loop

Q9

$$\Delta S = mc \ln \frac{T_f}{T_i} = 0.2 (4.19 \times 10^3) \ln \frac{50 + 273}{273} = 1.41 \text{ kW}^2 \text{ J/k}$$

Q10

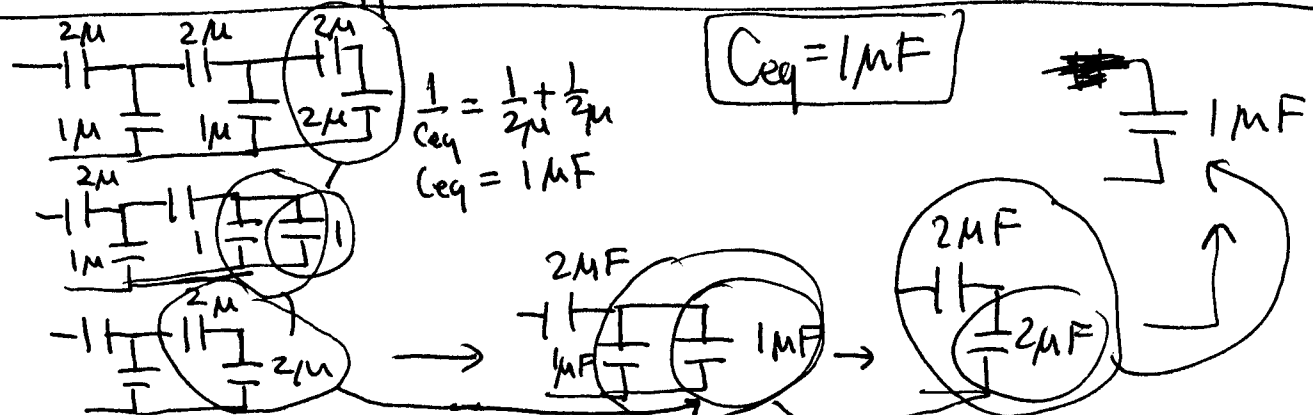

Apr 26, 02

Phys102 - major 2 - 002 - p3

Q11

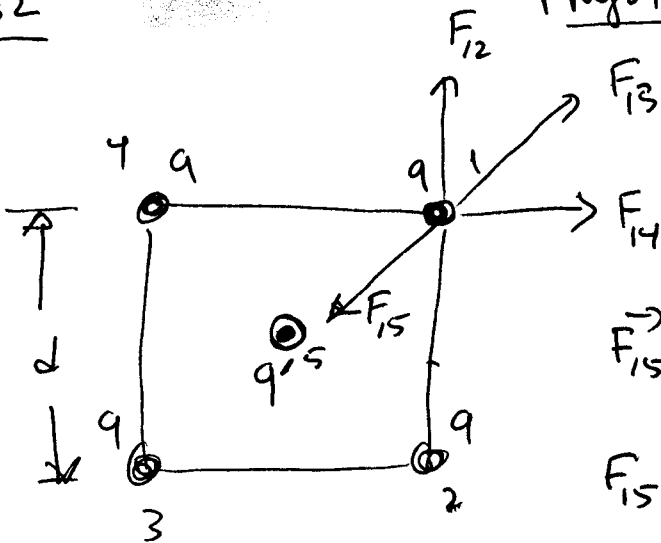

$$\vec{F}_{15} = \vec{F}_{12} + \vec{F}_{13} + \vec{F}_{14}$$

$$F_{15} = \sqrt{F_{12}^2 + F_{14}^2} + F_{13}$$

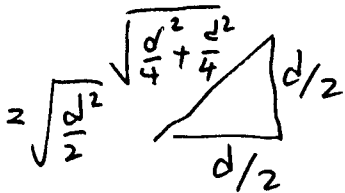

$$\frac{kqq'}{d^2} = \sqrt{\left(\frac{kq^2}{d^2}\right)^2 + \left(\frac{kq^2}{d^2}\right)^2} + \frac{kq^2}{(\sqrt{2}d)^2}$$

$$2\frac{kqq'}{d^2} = \frac{kq^2}{d^2} \left[\sqrt{2} + \frac{1}{2} \right]$$

$$2q' = q \left[\sqrt{2} + \frac{1}{2} \right]$$

$$q' = q \left[\frac{\sqrt{2}}{2} + \frac{1}{4} \right] = 0.96 \mu\text{C}$$

Q12

$$W_{\text{app}} = QV$$

$$= Q \left[k\frac{q}{\frac{d}{\sqrt{2}}} + k\frac{q}{\frac{d}{\sqrt{2}}} + k\frac{(-2q)}{\frac{d}{\sqrt{2}}} + k\frac{(-2q)}{\frac{d}{\sqrt{2}}} \right]$$

$$= Q \frac{kq}{d} \sqrt{2} [2 - 4]$$

$$= -2\sqrt{2} k \frac{Qq}{d} = -2.8 k \frac{Qq}{d}$$

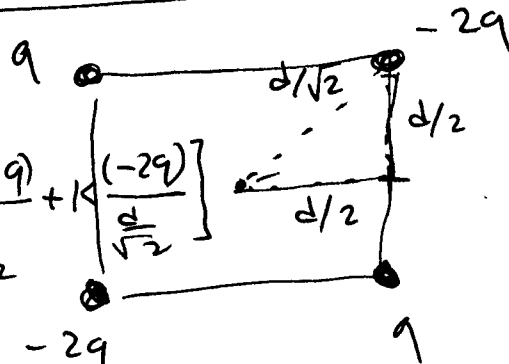

Q13

$$V = IR \quad \checkmark \frac{I}{A}$$

$$= \frac{IA}{A} R = JAR = \frac{JARE}{l} = Jpl$$

$$110 = \frac{1.5 \times 10^6 (48.2 \times 10^{-8})}{110} l$$

$$l = \frac{110}{1.5 \times 10^6 (48.2 \times 10^{-8})} = 152 \text{ m}$$

Apr 27, 02

Phys 102 - major 2 - 002 - p4

Q14

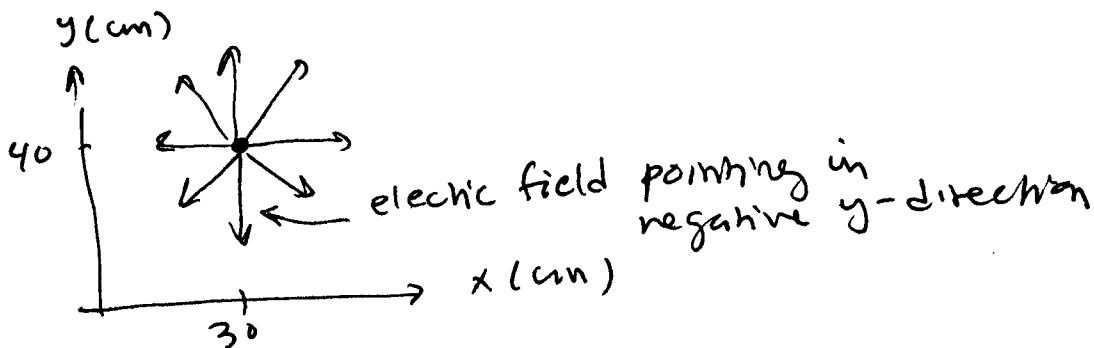

$$E = k \frac{q}{r^2}$$

r ← distance from the charge

$$r = \sqrt{\frac{kq}{E}} = \sqrt{\frac{8.99 \times 10^9 \cdot 4 \times 10^{-9}}{72}} = -30.7$$

at (30.0, -30.7) E is 72 pointing along -ve y-axis

Q15

$$P = qd = (6 \mu)(3 \times 10^{-3}) = 18 \times 10^{-9} \text{ C}\cdot\text{m}$$

in the negative x-axis direction

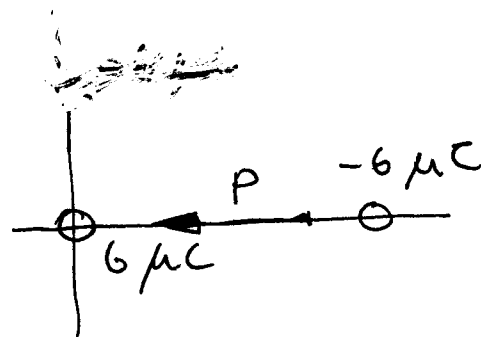

Q16

$$P - P_0 = \alpha P_0 (T - T_0)$$

$$; P = 2P_0$$

$$2P_0 - P_0 = \alpha P_0 (T - T_0)$$

$$1 = \alpha (T - T_0) \Rightarrow T = \frac{1}{\alpha} + T_0 = \frac{1}{2 \times 10^{-2}} + 30 = 80^\circ \text{C}$$

Q17

$$W_{op} = Q\Delta V = 0$$

Q18

$$T = qE$$

To find E, Supper impose electric field from positive and negative plates



+ve plate

$$E_{+A} + E_{-A} = \frac{\sigma_{+A}}{\epsilon_0}$$

$$E_{+} = \frac{\sigma_{+}}{2\epsilon_0}$$

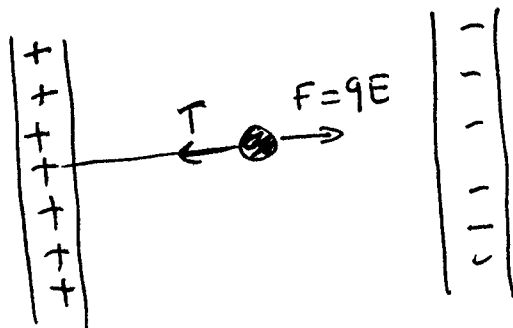

Apr 27, 02

Phys 102, major 2 - 002 - PS

-ve plate

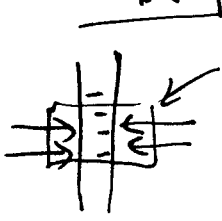

Gaussian surface
flux through the surface = $\frac{Q_{in}}{\epsilon_0}$

$$E_+ A + E_- A = \frac{\sigma_- A}{\epsilon_0} \Rightarrow E_- = \frac{\sigma_-}{2\epsilon_0}$$

between the two plates $\vec{E} = (E_+ + E_-) \hat{c}$
 $= \frac{1}{2\epsilon_0} (\sigma_+ + |\sigma_-|) \hat{c}$

$$E = \frac{2(8.9 \times 10^{-4})}{2(8.85 \times 10^{-12})}$$

$$T = 6.0 \times 10^{-8} \frac{8.9 \times 10^{-4}}{8.85 \times 10^{-12}} = 6.0 \text{ N}$$

Q19 Mechanical energy is conserved

$$K_A + U_A = K_B + U_B$$

$$\frac{1}{2} m v_A^2 + (U_A - U_B) = K_B$$

initial v_0

final $v_0 + 2 \times 10^3 \text{ V}$

$$K_B = \frac{1}{2} (8 \times 10^{-9}) (80)^2 + 6 \times 10^{-9} (v_0 - (v_0 + 2 \times 10^3))$$

$$= \frac{1}{2} (8 \times 10^{-9}) (80)^2 + 6 \times 10^{-9} (2 \times 10^3) = 14 \times 10^{-6} \text{ J}$$

Q20 1 and 4