

Introduction To Mathematica

By: Dr. Rajai Alassar

E-mail: aalassar@kfupm.edu.sa Homepage:

<http://faculty.kfupm.edu.sa/math/aalassar>

Released in 1988 as a fully integrated system for technical computing with the visionary concept to create once and for all a single system that could handle all the various aspects of technical computing in a coherent way.

- You normally interact with *Mathematica* through documents called notebooks.
- Notebooks consist of cells that can contain text, calculations, or graphics.
- Cells are indicated by brackets on the right.
- Input for *Mathematica* to evaluate goes in input cells.
- To create a new input cell, just click outside an existing cell and start typing.
- When you have finished, press `SHIFT+ENTER`. *Mathematica* evaluates your input and puts the result in an output cell immediately underneath.

Numerical Calculations

Addition, Subtraction, Multiplication, Division, and Powers

```
In[1]:= 1 + 2
```

```
Out[1]= 3
```

```
In[2]:= 3 - 9
```

```
Out[2]= -6
```

You can either use a star or space between numbers

```
In[3]:= -2 * 6
```

```
Out[3]= -12
```

```
In[4]:= -2 6
```

```
Out[4]= -12
```

```
In[5]:= 8 / 2
```

```
Out[5]= 4
```

```
In[6]:= 7 / 3
```

```
Out[6]=  $\frac{7}{3}$ 
```

```
In[7]:= 2 ^ 3
```

```
Out[7]= 8
```

```
In[8]:= 2 ^ (1 / 3)
```

```
Out[8]=  $2^{1/3}$ 
```

```
In[9]:= 5 ^ (1 / 2)
```

```
Out[9]=  $\sqrt{5}$ 
```

Approximating Numbers

To approximate $2^{1/3}$ or $\sqrt{5}$, we can use `N` as

```
In[10]:= N[2 ^ (1 / 3)]
```

```
Out[10]= 1.25992
```

```
In[11]:= N[2^(1/3), 500]
```

```
Out[11]= 1.25992104989487316476721060727822835057025146470150798008197511215529967651.
395948372939656243625509415431025603561566525939902404061373722845911030426.
935524696064261662500097747452656548030686718540551868924587251676419937370.
969509838278316139915512931369536618394746344857657030311909589598474110598.
116290705359081647801147352132548477129788024220858205325797252666220266900.
566560819947156281764050606648267735726704194862076214429656942050793191724.
41480920448232840127470321964282081201905714188996
```

```
In[12]:= 5^(1/2) // N
```

```
Out[12]= 2.23607
```

```
In[13]:= 2 + 3 / 4
```

```
Out[13]=  $\frac{11}{4}$ 
```

```
In[14]:= 2. + 3 / 4
```

```
Out[14]= 2.75
```

```
In[15]:= 2^100
```

```
Out[15]= 1267650600228229401496703205376
```

```
In[16]:= 2.^100
```

```
Out[16]=  $1.26765 \times 10^{30}$ 
```

Order of Operations

Brackets -> Powers -> Multiplication/Division -> Addition/Subtraction

```
In[17]:= 4 + 8 / 2
```

```
Out[17]= 8
```

```
In[18]:= (4 + 8) / 2
```

```
Out[18]= 6
```

```
In[19]:= -3^2 / 4
```

```
Out[19]=  $-\frac{9}{4}$ 
```

```
In[20]:= (-3)^2 / 4
```

```
Out[20]=  $\frac{9}{4}$ 
```

```
In[21]:= -3^(2/4)
```

```
Out[21]=  $-\sqrt{3}$ 
```

```
In[22]:= (-3)^(2/4)
```

```
Out[22]= i√3
```

Note : $i = \sqrt{-1}$

Using *Mathematica's* Palettes

```
In[23]:= 2^3 + 4/2 + √16 + ∛27
```

```
Out[23]= 17
```

Built-In Constants

```
In[24]:= Pi + π
```

```
Out[24]= 2π
```

```
In[25]:= N[Pi]
```

```
Out[25]= 3.14159
```

```
In[26]:= E^2 + e^2
```

```
Out[26]= 2e^2
```

```
In[27]:= N[E, 20]
```

```
Out[27]= 2.7182818284590452354
```

```
In[28]:= I * i
```

```
Out[28]= -1
```

```
In[29]:= (i - 1)^4 / (1 + i)
```

```
Out[29]= -2 + 2i
```

```
In[30]:= Infinity + ∞
```

```
Out[30]= ∞
```

Built-In Functions

The names of built-in *Mathematica* functions begin with *capital letters*

The arguments of *Mathematica* functions are enclosed in *square brackets*

In[31]:= Exp[-2]

Out[31]= $\frac{1}{e^2}$

In[32]:= N[$\frac{1}{e^2}$]

Out[32]= 0.135335

In[33]:= Abs[-2]

Out[33]= 2

In[34]:= Sqrt[2]

Out[34]= $\sqrt{2}$

In[35]:= Factorial[4]

Out[35]= 24

In[36]:= 4!

Out[36]= 24

**The function Log[x] is the natural logarithmic function In x.
Log[a,x] is the logarithmic function with base a.**

In[37]:= Log[2]

Out[37]= Log[2]

In[38]:= Log[E]

Out[38]= 1

In[39]:= Log[10, 100]

Out[39]= 2

In[40]:= Log[2, 10]

Out[40]= $\frac{\text{Log}[10]}{\text{Log}[2]}$

In[41]:= Log[2, 10] // N

Out[41]= 3.32193

In[42]:= Cos[$\frac{\pi}{4}$] + Sec[$\frac{\pi}{4}$]

Out[42]= $\frac{1}{\sqrt{2}} + \sqrt{2}$

In[43]:= $\cos\left(\frac{\pi}{4}\right)$

General::spell1 :

Possible spelling error: new symbol name "cos" is similar to existing symbol "Cos". More...

Out[43]= $\frac{\cos \pi}{4}$

In[44]:= $\tan\left[\frac{\pi}{3}\right] + \cot\left[\frac{\pi}{3}\right]$

Out[44]= $\frac{1}{\sqrt{3}} + \sqrt{3}$

In[45]:= $\sin[30] + \csc\left[\frac{\pi}{6}\right]$

Out[45]= $2 + \sin[30]$

In[46]:= $\sin[30] // N$

Out[46]= -0.988032

Use 'Degree' if the argument is specified in degrees and not radians

In[47]:= $\sin[30 \text{ Degree}] // N$

Out[47]= 0.5

In[48]:= $\sin[\pi / 4]^2$

Out[48]= $\frac{1}{2}$

In[49]:= $\sin^2[\pi / 4]$

Out[49]= $\sin^2\left[\frac{\pi}{4}\right]$

In[50]:= $\sin\left[\frac{5\pi}{4}\right]$

Out[50]= $-\frac{1}{\sqrt{2}}$

In[51]:= $\text{ArcSin}\left[-\frac{1}{\sqrt{2}}\right]$

Out[51]= $-\frac{\pi}{4}$

In[52]:= $\sinh[-5] // N$

Out[52]= -74.2032

In[53]:= $\text{ArcSinh}[-74.2]$

Out[53]= -4.99996

Some interesting functions

Round: rounds a number to its closest integer

Mod: returns the remainder when dividing two numbers

Random: returns a random number between 0 and 1

Max: (Min) selects the maximum (minimum) number in a list

FactorInteger: factors an integer to its prime numbers

```
In[54]:= Round[3.1]
```

```
Out[54]= 3
```

```
In[55]:= Mod[11, 3]
```

```
Out[55]= 2
```

```
In[56]:= Random[]
```

```
Out[56]= 0.13218
```

```
In[57]:= Max[1, -3, 4.01, 2,  $\sqrt{17}$ , 6.2 * Abs[Sin[7]]]
```

```
Out[57]=  $\sqrt{17}$ 
```

```
In[58]:= FactorInteger[1627956652000]
```

```
Out[58]= {{2, 5}, {5, 3}, {7, 1}, {17, 2}, {23, 1}, {8747, 1}}
```

The functions:

Re: returns the real part of a complex number

Im: returns the imaginary part of a complex number

Others are self-explanatory

```
In[59]:= Re[1 + 2 i]
```

```
Out[59]= 1
```

```
In[60]:= Im[1 + 2 i]
```

```
Out[60]= 2
```

```
In[61]:= Abs[1 + 2 i]
```

```
Out[61]=  $\sqrt{5}$ 
```

```
In[62]:= Conjugate[1 + 2 i]
```

```
Out[62]= 1 - 2 i
```

```
In[63]:= Arg[1 + 2 i]
```

```
Out[63]= ArcTan[2]
```

```
In[64]:= Arg[1 + 2 i] // N
```

```
Out[64]= 1.10715
```

```
In[65]:= Plot[Sin[x], {x, 0, 4 π}]
```

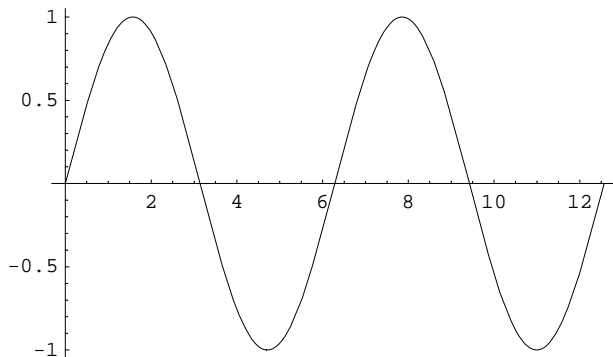

```
Out[65]= - Graphics -
```

Using Previous Results

```
In[66]:= 2 ^ 2
```

```
Out[66]= 4
```

You can use the last output as %

```
In[67]:= % + 1
```

```
Out[67]= 5
```

```
In[68]:= 2 * % + 7
```

```
Out[68]= 17
```

You can use Out[n] or equivalently %n (n is the number of output line)

```
In[69]:= %67 + 6 * Out[66]
```

```
Out[69]= 29
```

Defining Variables

x = value

assign a value to x

x = y = value

assign a value to both x and y

```
In[70]:= x = 4
```

```
Out[70]= 4
```



```
In[71]:= z =  $\sqrt{x}$ 
```

```
Out[71]= 2
```

```
In[72]:= x = y = 5
```

```
Out[72]= 5
```

```
In[73]:= x
```

```
Out[73]= 5
```

```
In[74]:= y^3
```

```
Out[74]= 125
```

```
In[75]:= y = 7
```

```
Out[75]= 7
```

```
In[76]:= x + y + z
```

```
Out[76]= 14
```

x = . or Clear [x] remove any value assigned

```
In[77]:= Clear[x]
```

```
In[78]:= x
```

```
Out[78]= x
```

```
In[79]:= y
```

```
Out[79]= 7
```

```
In[80]:= y = .
```

```
In[81]:= y
```

```
Out[81]= y
```

```
In[82]:= z = .
```

Note:

Values assigned are permanent until you clear them or start a new session

No limit on the length of names

Names can not start with numbers (x2 is a name but 2x means 2*x)

x y means x*y

xy with no space means the variable with name xy

x^2y means $(x^2)y$, not $x^{(2y)}$

Advice:

Remove values you assign as soon as you finish using them

To avoid confusion with built-in functions which start with capital letters, use lower-case letters for variables

Suppressing Output (Use `;`)

```
In[83]:= u = 3
```

```
Out[83]= 3
```

```
In[84]:= v = 7;
```

```
In[85]:= u = 2; v = 3; w = 5
```

```
Out[85]= 5
```

```
In[86]:= v
```

```
Out[86]= 3
```

```
In[87]:= u = 1; v = 2; w = 3;
```

```
In[88]:= Clear[u, v, w]
```

```
In[89]:= u
```

```
Out[89]= u
```

Naming, Defining, and Evaluating Expressions and Functions

Name objects to avoid typing the same expression repeatedly

Every object can be named including graphics and functions

Remember to use lower-case letters

```
In[90]:= ahmad =  $\frac{x^3 + 2x^2 - x - 2}{x^3 + x^2 - 4x - 4}$ ;
```

Observe that there is no output because we used `(:)`. Now type `ahmad` to get the expression

```
In[91]:= ahmad
```

```
Out[91]=  $\frac{-2 - x + 2x^2 + x^3}{-4 - 4x + x^2 + x^3}$ 
```

You can evaluate an expression by the command `ReplaceAll` which is abbreviated with `/.` together with a rule abbreviated with `->`

```
In[92]:= x2 /. x -> 4
```

```
Out[92]= 16
```

```
In[93]:= ahmad /. x -> 4
```

```
Out[93]=  $\frac{3}{2}$ 
```

When you first define a function, you must enclose the argument by square brackets and place an underscore "`_`" after the argument on the left hand side of the equal sign. When evaluating the function, do not use the underscore.

```
In[94]:= f[x_] = x2
```

```
Out[94]= x2
```

```
In[95]:= f[2]
```

```
Out[95]= 4
```

```
In[96]:= g[x_] =  $\sqrt{x}$ 
```

```
Out[96]=  $\sqrt{x}$ 
```

```
In[97]:= g[x] /. x -> 9
```

```
Out[97]= 3
```

```
In[98]:=  $\frac{f[x+h] - f[x]}{h}$ 
```

```
Out[98]=  $\frac{-x^2 + (h+x)^2}{h}$ 
```

```
In[99]:= Simplify[%]
```

```
Out[99]= h + 2 x
```

You can find the composition of functions

```
In[100]:=
```

```
    f[g[x]]
```

```
Out[100]=
```

```
    x
```

Or by using the command '`Composition`'

```
In[101]:=
  Composition[f, g][x]
```

```
Out[101]=
  x
```

```
In[102]:=
  Clear[f, g]
```

You can define functions piecewise.

Please observe the use of := instead of = because $f[x]$ does not make sense unless x is a particular number. '=' is used for delayed definition.

Observe also the use of /; to designate different domain values

```
In[103]:=
  f[x_] := x2 + 1 /; x ≥ 0
  f[x_] := -x - 1 /; x < 0
```

```
In[105]:=
  Plot[f[x], {x, -3, 3}]
```

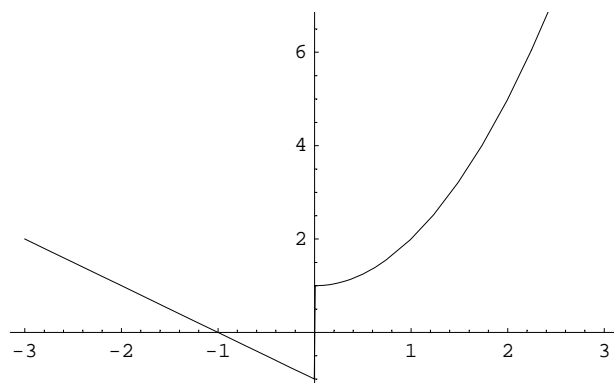

```
Out[105]=
  - Graphics -
```

```
In[106]:=
  Clear[f]
```

You can define functions of several variables

```
In[107]:=
  f[x_, y_] = 1 - Sin[x2 + y2]
```

```
Out[107]=
  1 - Sin[x2 + y2]
```

In[108]:=

$$f\left[2\sqrt{\pi}, \frac{3\sqrt{\pi}}{2}\right]$$

Out[108]=

$$1 - \frac{1}{\sqrt{2}}$$

In[109]:=

f[0, a]

Out[109]=

$$1 - \text{Sin}[a^2]$$

You can define a vector-valued function of one or two variables

In[110]:=

Clear[f, g]

In[111]:=

f[t_] = {t², 1 - t²}

Out[111]=

{t², 1 - t²}

In[112]:=

f[1]

Out[112]=

{1, 0}

In[113]:=

f[Sin[c]]

Out[113]=

{Sin[c]², 1 - Sin[c]²}

In[114]:=

g[s_, t_] = {Cos[s² - t²], Sin[s² - t²]}

Out[114]=

{Cos[s² - t²], Sin[s² - t²]}

In[115]:=

g[1, 2]

Out[115]=

{Cos[3], -Sin[3]}

In[116]:=

g[π, -π]

Out[116]=

{1, 0}

In[117]:=

g[s, t] /. {s → 1, t → 2}

Out[117]=

{Cos[3], -Sin[3]}

Algebraic Expressions & Equations

The following are important commands:

Expand: expands out products and positive integer powers

Factor: factors a polynomial over the integers

Simplify: returns the simplest form it finds

Together: puts terms in a sum over a common denominator, and cancels factors in the result

Apart: rewrites a rational expression as a sum of terms with minimal denominators

Collect[*expr*, *x*]: collects together terms involving the same powers of objects matching *x*

Coefficient[*expr*, *form*]: gives the coefficient of *form* in the polynomial *expr*

Exponent[*expr*, *form*]: gives the maximum power with which *form* appears in the expanded form of *expr*

In[118]:=

`Expand[(1 + x)2]`

Out[118]=

$1 + 2x + x^2$

In[119]:=

`Expand` $\left[\frac{(-1 + x)^2 (2 + x)}{(-3 + x)^2 (1 + x)}\right]$

Out[119]=

$$\frac{2}{(-3 + x)^2 (1 + x)} - \frac{3x}{(-3 + x)^2 (1 + x)} + \frac{x^3}{(-3 + x)^2 (1 + x)}$$

In[120]:=

Factor[$12 x^2 + 27 x y - 84 y^2$]

Out[120]=

$3 (4 x - 7 y) (x + 4 y)$

In[121]:=

Factor[$1 + 4 x + 6 x^2 + 4 x^3 + x^4 + 12 y + 36 x y + 36 x^2 y + 12 x^3 y + 54 y^2 + 108 x y^2 + 54 x^2 y^2 + 108 y^3 + 108 x y^3 + 81 y^4$]

Out[121]=

$(1 + x + 3 y)^4$

In[122]:=

Simplify[$\frac{1}{4 (-1 + x)} - \frac{1}{4 (1 + x)} - \frac{1}{2 (1 + x^2)}$]

Out[122]=

$\frac{1}{-1 + x^4}$

In[123]:=

Apart[$\frac{-7 - 6 x + 5 x^2}{(-3 + x)^2 (1 + x)}$]

Out[123]=

$\frac{5}{(-3 + x)^2} + \frac{19}{4 (-3 + x)} + \frac{1}{4 (1 + x)}$

Please observe the difference between Apart and Expand

In[124]:=

Expand[$\frac{-7 - 6 x + 5 x^2}{(-3 + x)^2 (1 + x)}$]

Out[124]=

$-\frac{7}{(-3 + x)^2 (1 + x)} - \frac{6 x}{(-3 + x)^2 (1 + x)} + \frac{5 x^2}{(-3 + x)^2 (1 + x)}$

In[125]:=

Together[$\frac{2}{x^2} - \frac{x^2}{2}$]

Out[125]=

$\frac{4 - x^4}{2 x^2}$

In[126]:=

saleh = Expand[($3 + 2 x + y$)³]

Out[126]=

$27 + 54 x + 36 x^2 + 8 x^3 + 27 y + 36 x y + 12 x^2 y + 9 y^2 + 6 x y^2 + y^3$

In[127]:=

saleh

Out[127]=

$27 + 54 x + 36 x^2 + 8 x^3 + 27 y + 36 x y + 12 x^2 y + 9 y^2 + 6 x y^2 + y^3$

In[128]:=

Collect[saleh, y]

Out[128]=

$27 + 54 x + 36 x^2 + 8 x^3 + (27 + 36 x + 12 x^2) y + (9 + 6 x) y^2 + y^3$

In[129]:=

Collect[saleh, x]

Out[129]=

$27 + 8 x^3 + 27 y + 9 y^2 + y^3 + x^2 (36 + 12 y) + x (54 + 36 y + 6 y^2)$

In[130]:=

Coefficient[saleh, x²]

Out[130]=

$36 + 12 y$

In[131]:=

Exponent[saleh, y]

Out[131]=

3

One can also use the Palettes to evaluate expressions. First type the expression. Then, highlight it or select it. Finally, move the cursor on the palette and chose your command. Now try factoring the following expression in place by using the 'AlgebraicManipulation' Palette from the file menu

In[132]:=

$1 + x^6$

Out[132]=

$1 + x^6$

Equations

We use the 'double equals' $= =$ in *Mathematica* to specify an equation

In[133]:=

Solve[x² + x - 2 == 0]

Out[133]=

{ {x → -2}, {x → 1} }

In[134]:=

eqn1 = x³ + x² + x + 1 == 0

Out[134]=

$1 + x + x^2 + x^3 == 0$

In[135]:=

eqn1

Out[135]=

$$1 + x + x^2 + x^3 == 0$$

In[136]:=

Solve[eqn1]

Out[136]=

{{x → -1}, {x → -i}, {x → i}}

In[137]:=

Solve[x² + 2 x - 7 == 0]

Out[137]=

{{x → -1 - 2 √2}, {x → -1 + 2 √2}}

In[138]:=

N[%]

Out[138]=

{{x → -3.82843}, {x → 1.82843}}

In[139]:=

Solve[x⁶ - 1 == 0]

Out[139]=

{{x → -1}, {x → 1}, {x → -(-1)^{1/3}}, {x → (-1)^{1/3}}, {x → -(-1)^{2/3}}, {x → (-1)^{2/3}}}

In[140]:=

N[%]

Out[140]=

{{x → -1.}, {x → 1.}, {x → -0.5 - 0.866025 i},
{x → 0.5 + 0.866025 i}, {x → 0.5 - 0.866025 i}, {x → -0.5 + 0.866025 i}}

In[141]:=

Factor[x⁶ - 1]

Out[141]=

(-1 + x) (1 + x) (1 - x + x²) (1 + x + x²)

In[142]:=

eqn2 = Sin[x]² - 2 Sin[x] - 3 == 0

Out[142]=

$$-3 - 2 \sin[x] + \sin[x]^2 == 0$$

In[143]:=

Solve[eqn2]

Out[143]=

{{Sin[x] → -1}, {Sin[x] → 3}}

Remember to specify which variable you are trying to solve for

In[144]:=

`Solve[eqn2, x]`

Solve::ifun : Inverse functions are being used by Solve, so some solutions may not be found; use Reduce for complete solution information. More...

Out[144]=

$\left\{\left\{x \rightarrow -\frac{\pi}{2}\right\}, \left\{x \rightarrow \text{ArcSin}[3]\right\}\right\}$

In[145]:=

`N[%]`

Out[145]=

$\left\{\left\{x \rightarrow -1.5708\right\}, \left\{x \rightarrow 1.5708 - 1.76275 i\right\}\right\}$

Systems of Equations

In[146]:=

`Solve[{3 x - y == 4, x + y == 2}, {x, y}]`

Out[146]=

$\left\{\left\{x \rightarrow \frac{3}{2}, y \rightarrow \frac{1}{2}\right\}\right\}$

In[147]:=

`sys1 = {2 x - 3 y + 4 z == 2, 3 x - 2 y + z == 0, x + y - z == 1}`

Out[147]=

$\{2 x - 3 y + 4 z == 2, 3 x - 2 y + z == 0, x + y - z == 1\}$

In[148]:=

`solsys1 = Solve[sys1, {x, y, z}]`

Out[148]=

$\left\{\left\{x \rightarrow \frac{7}{10}, y \rightarrow \frac{9}{5}, z \rightarrow \frac{3}{2}\right\}\right\}$

You can verify the solution set

In[149]:=

`sys1 /. solsys1`

Out[149]=

$\{\{\text{True}, \text{True}, \text{True}\}\}$

In[150]:=

`sys2 = {2 x - 2 y - 2 z == -2, -x + y + 3 z == 0, -3 x + 3 y - 2 z == 1}`

Out[150]=

$\{2 x - 2 y - 2 z == -2, -x + y + 3 z == 0, -3 x + 3 y - 2 z == 1\}$

In[151]:=

`Solve[sys2, {x, y, z}]`

Out[151]=

$\{\}$

In[152]:=

```
sys3 = {-2 x + 2 y - 2 z == -2, 3 x - 2 y + 2 z == 2, x + 3 y - 3 z == -3}
```

Out[152]=

```
{-2 x + 2 y - 2 z == -2, 3 x - 2 y + 2 z == 2, x + 3 y - 3 z == -3}
```

In[153]:=

```
Solve[sys3, {x, y, z}]
```

Solve::svars : Equations may not give solutions for all "solve" variables. More...

Out[153]=

```
{{x -> 0, y -> -1 + z}}
```

In[154]:=

```
sys4 = {a x + y == 0, 2 x + (1 - a) y == 1}
```

Out[154]=

```
{a x + y == 0, 2 x + (1 - a) y == 1}
```

In[155]:=

```
Eliminate[sys4, y]
```

Out[155]=

```
(2 - a + a2) x == 1
```

We can get approximate solutions of complicated equations using 'NSolve'

In[156]:=

```
NSolve[x7 - x6 + 3 x2 + 5 x - 2 == 0]
```

Out[156]=

```
{{x -> -1.028 - 0.511372 i}, {x -> -1.028 + 0.511372 i},  
{x -> -0.0481076 - 1.34022 i}, {x -> -0.0481076 + 1.34022 i},  
{x -> 0.333464}, {x -> 1.40937 - 0.737106 i}, {x -> 1.40937 + 0.737106 i}}
```

We can also use 'FindRoot' with some initial guess written as {x,number}

To determine the initial guess, you may want to plot the graph

Example: Find a root of $f(x) = \ln x + \sin(x+1) - \sqrt{x} - 1$

In[157]:=

```
Plot[Log[10 x + 1] + Sin[x + 1] -  $\sqrt{x}$  - 1, {x, 0, 20}]
```

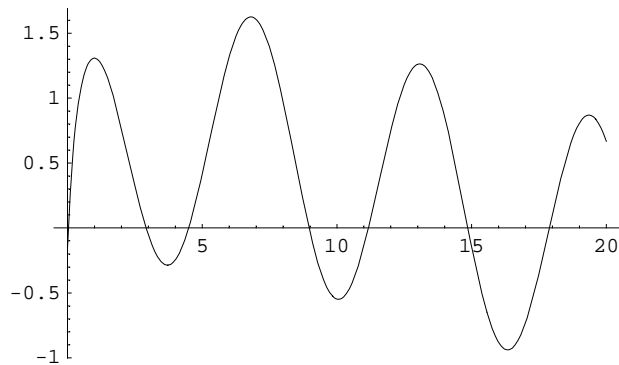

Out[157]=

- Graphics -

In[158]:=

```
FindRoot[Log[10 x + 1] + Sin[x + 1] -  $\sqrt{x}$  - 1 == 0, {x, 7}]
```

Out[158]=

{x -> 14.8616}

Calculus

Limits

Limit[*expr*, x -> *x0*] finds the limiting value of *expr* when *x* approaches *x0*

In[159]:=

```
Limit[x2 - 3 x + 2, x -> 3]
```

Out[159]=

2

```
In[160]:=
```

```
Plot[ $\frac{\text{Sin}[x]}{x}$ , {x, -4, 4}]
```

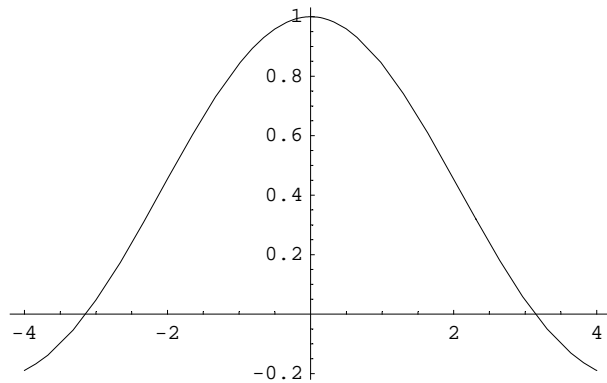

```
Out[160]=
```

```
- Graphics -
```

```
In[161]:=
```

```
Limit[ $\frac{\text{Sin}[x]}{x}$ , x  $\rightarrow$  0]
```

```
Out[161]=
```

```
1
```

```
In[162]:=
```

```
w =  $\frac{x^3 - 1}{x - 1}$ 
```

```
Out[162]=
```

```
 $\frac{-1 + x^3}{-1 + x}$ 
```

```
In[163]:=
```

```
Plot[w, {x, -2, 2}]
```

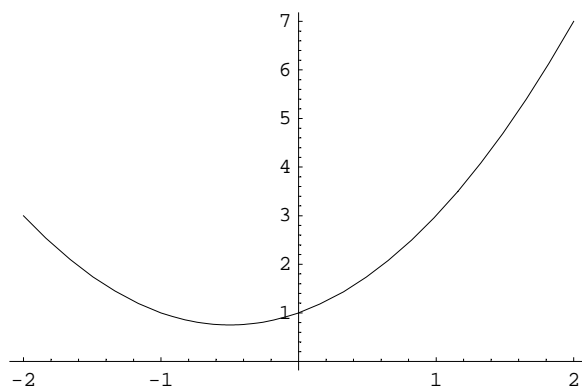

```
Out[163]=
```

```
- Graphics -
```

```
In[164]:=
w /. x -> 1
Power::infty : Infinite expression  $\frac{1}{0}$  encountered. More...
∞::indet : Indeterminate expression 0 ComplexInfinity encountered. More...
```

```
Out[164]=
Indeterminate
```

```
In[165]:=
Factor[Numerator[w]]
```

```
Out[165]=
(-1 + x) (1 + x + x2)
```

```
In[166]:=
Cancel[w]
```

```
Out[166]=
1 + x + x2
```

```
In[167]:=
% /. x -> 1
```

```
Out[167]=
3
```

```
In[168]:=
Limit[ $\frac{x^3 - 1}{x - 1}$ , x -> 1]
```

```
Out[168]=
3
```

```
In[169]:=
Limit[(1 + 2 x)1/x, x -> 0]
```

```
Out[169]=
e2
```

```
In[170]:=
Limit[ $\sqrt[3]{\frac{3x^2 + 5x + 2}{1 - x^2}}$ , x -> ∞]
```

```
Out[170]=
(-3)1/3
```

Limit[exp, x -> x₀, Direction -> 1] computes the limit as x approaches x_0 from smaller values. **Limit[exp, x -> x₀, Direction -> -1]** computes the limit as x approaches x_0 from larger values

```
In[171]:=
```

```
Plot[1/x, {x, -1, 1}]
```

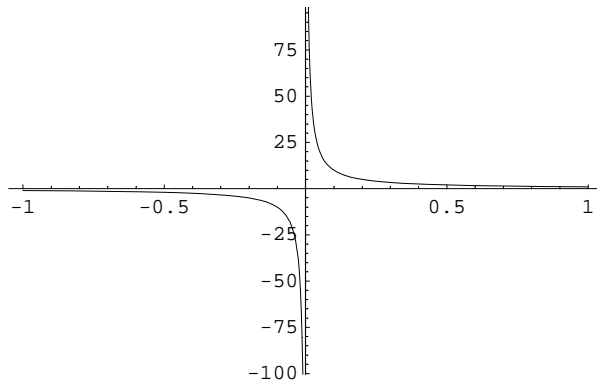

```
Out[171]=
```

```
- Graphics -
```

```
In[172]:=
```

```
Limit[1/x, x -> 0, Direction -> 1]
```

```
Out[172]=
```

```
-∞
```

```
In[173]:=
```

```
Limit[1/x, x -> 0, Direction -> -1]
```

```
Out[173]=
```

```
∞
```

Some limits are hard to evaluate. The limit can, however, be evaluated numerically using the command `NLimit`. You need to load the proper package

```
In[174]:=
```

```
<< NumericalMath`NLimit`
```

```
In[175]:=
```

```
NLimit[2^x/x!, x -> ∞]
```

```
Out[175]=
```

```
0.
```

Derivatives

f' or $\partial_x f$ represents the derivative of a function f of one argument

`D[f, x]` gives the partial derivative $\partial f / \partial x$

$D[f, \{x, n\}]$ gives the multiple derivative $\partial^n f / \partial x^n$

$D[f, x_1, x_2, \dots]$ gives $\partial / \partial x_1 \partial / \partial x_2 \dots f$

In[176]:=

```
Clear[h]
```

In[177]:=

```
h[x_] = ArcTan[x]
```

Out[177]=

```
ArcTan[x]
```

In[178]:=

```
dh[x_] = h'[x]
```

Out[178]=

$$\frac{1}{1+x^2}$$

In[179]:=

```
g1 = Plot[{h[x], dh[x]}, {x, -5, 5},
  PlotStyle -> {{RGBColor[0, 1, 0], Dashing[{0.02]}], RGBColor[0, 0, 1]},
  DisplayFunction -> Identity]
```

Out[179]=

```
- Graphics -
```

In[180]:=

```
eq = h'[2] (x - 2) + h[2]; peq = Plot[eq, {x, 1, 3},
  PlotStyle -> {RGBColor[1, 0, 0], Thickness[0.01]}, DisplayFunction -> Identity];
```

In[181]:=

```
pnt =
  Show[Graphics[{PointSize[0.02], Point[{2, h[2]}]}], DisplayFunction -> Identity]
```

Out[181]=

```
- Graphics -
```

In[182]:=

```
Show[peq, g1, pnt, DisplayFunction -> $DisplayFunction]
```

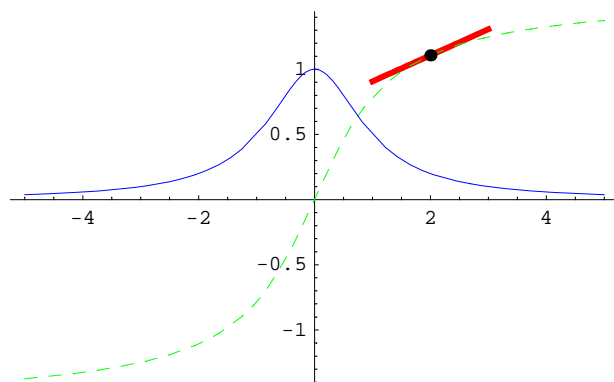

Out[182]=

```
- Graphics -
```



```
In[183]:=
```

```
h''[x]
```

```
Out[183]=
```

$$-\frac{2x}{(1+x^2)^2}$$

```
In[184]:=
```

```
h''[-2]
```

```
Out[184]=
```

$$\frac{4}{25}$$

```
In[185]:=
```

```
D[x^2, x]
```

```
Out[185]=
```

$$2x$$

```
In[186]:=
```

```
 $\partial_x x^4$ 
```

```
Out[186]=
```

$$4x^3$$

```
In[187]:=
```

```
D[x^4, {x, 3}]
```

```
Out[187]=
```

$$24x$$

```
In[188]:=
```

```
 $\partial_{\{x,3\}} x^4$ 
```

```
Out[188]=
```

$$24x$$

```
In[189]:=
```

```
D[x^2 y + Sin[x + y], x, y]
```

```
Out[189]=
```

$$2x - \text{Sin}[x + y]$$

```
In[190]:=
```

```
 $\partial_{x,y} (x^2 y + \text{Sin}[x + y])$ 
```

```
Out[190]=
```

$$2x - \text{Sin}[x + y]$$

```
In[191]:=
```

```
 $\partial_{x,\{y,2\}} (x^2 y + \text{Sin}[x + y])$ 
```

```
Out[191]=
```

$$-\text{Cos}[x + y]$$

Implicit Differentiation

In[192]:=

$$\text{Dt}[(x^2 + y^2)^2 == 4(x^2 - y^2), x]$$

Out[192]=

$$2(x^2 + y^2)(2x + 2y \text{Dt}[y, x]) == 4(2x - 2y \text{Dt}[y, x])$$

In[193]:=

`Solve[%, Dt[y, x]]`

Out[193]=

$$\left\{ \left\{ \text{Dt}[y, x] \rightarrow \frac{2x - x^3 - xy^2}{y(2 + x^2 + y^2)} \right\} \right\}$$

In[194]:=

$$\text{D}[(x^2 + y[x]^2)^2 == 4(x^2 - y[x]^2), x]$$

Out[194]=

$$2(x^2 + y[x]^2)(2x + 2y[x] y'[x]) == 4(2x - 2y[x] y'[x])$$

In[195]:=

`Solve[%, y'[x]]`

Out[195]=

$$\left\{ \left\{ y'[x] \rightarrow \frac{2x - x^3 - xy[x]^2}{y[x](2 + x^2 + y[x]^2)} \right\} \right\}$$

Integration

In[196]:=

`Integrate[x, x]`

Out[196]=

$$\frac{x^2}{2}$$

In[197]:=

`Integrate[$\frac{\sin[\sqrt{x}]}{\sqrt{x}}$, {x, π^2 , $4\pi^2$ }]`

Out[197]=

$$-4$$

In[198]:=

`$\int \text{Sin}[\text{Log}[x]] \, dx$`

Out[198]=

$$-\frac{1}{2} x (\text{Cos}[\text{Log}[x]] - \text{Sin}[\text{Log}[x]])$$

In[199]:=

`$\int_0^{\frac{\pi}{4}} \text{Sin}[x]^{20} \, dx$`

Out[199]=

$$-\frac{44623}{322560} + \frac{46189 \pi}{1048576}$$

In[200]:=

$$\int \text{Tan}[x]^2 \text{Sec}[x]^4 dx$$

Out[200]=

$$\frac{1}{15} (4 + \text{Cos}[2x]) \text{Sec}[x]^2 \text{Tan}[x]^3$$

In[201]:=

`Simplify[%]`

Out[201]=

$$\frac{1}{15} (4 + \text{Cos}[2x]) \text{Sec}[x]^2 \text{Tan}[x]^3$$

The textbook by Anton gives the answer $\frac{1}{5} \text{Tan}[x]^5 + \frac{1}{3} \text{Tan}[x]^3$

In[202]:=

$$\text{Simplify}\left[\left(\frac{1}{5} \text{Tan}[x]^5 + \frac{1}{3} \text{Tan}[x]^3\right) - \left(\frac{1}{15} (4 + \text{Cos}[2x]) \text{Sec}[x]^2 \text{Tan}[x]^3\right)\right]$$

Out[202]=

0

In[203]:=

$$\int \frac{1}{x^2 \sqrt{4-x^2}} dx$$

Out[203]=

$$-\frac{\sqrt{4-x^2}}{4x}$$

In[204]:=

$$\int \frac{x^2 + x - 2}{3x^3 - x^2 + 3x - 1} dx$$

Out[204]=

$$\frac{3 \text{ArcTan}[x]}{5} - \frac{7}{15} \text{Log}[-1 + 3x] + \frac{2}{5} \text{Log}[1 + x^2]$$

In[205]:=

$$\text{Apart}\left[\frac{x^2 + x - 2}{3x^3 - x^2 + 3x - 1}\right]$$

Out[205]=

$$-\frac{7}{5(-1 + 3x)} + \frac{3 + 4x}{5(1 + x^2)}$$

In[206]:=

$$\int \% dx$$

Out[206]=

$$\frac{3 \text{ArcTan}[x]}{5} - \frac{7}{15} \text{Log}[-1 + 3x] + \frac{2}{5} \text{Log}[1 + x^2]$$

In[207]:=

$$\int \frac{\sqrt{x}}{1 + \sqrt[3]{x}} dx$$

Out[207]=

$$-6x^{1/6} + 2\sqrt{x} - \frac{6x^{5/6}}{5} + \frac{6x^{7/6}}{7} + 6 \text{ArcTan}[x^{1/6}]$$

In[208]:=

$$\int \frac{1}{1 - \sin[x] + \cos[x]} dx$$

Out[208]=

$$\text{Log}\left[\cos\left[\frac{x}{2}\right]\right] - \text{Log}\left[\cos\left[\frac{x}{2}\right] - \sin\left[\frac{x}{2}\right]\right]$$

In[209]:=

$$\int_0^1 e^{-x^2} dx$$

Out[209]=

$$\frac{1}{2} \sqrt{\pi} \text{Erf}[1]$$

In[210]:=

% // N

Out[210]=

0.746824

In[211]:=

$$\int_0^1 \sin[x^2] dx$$

Out[211]=

$$\sqrt{\frac{\pi}{2}} \text{FresnelS}\left[\sqrt{\frac{2}{\pi}}\right]$$

In[212]:=

% // N

Out[212]=

0.310268

When it is not possible to compute an exact value of an integral, Mathematica can approximate its value using NIntegrate

In[213]:=

$$\int_0^1 x^x dx$$

Out[213]=

$$\int_0^1 x^x dx$$

In[214]:=

NIntegrate[x^x, {x, 0, 1}]

Out[214]=

0.783431

In[215]:=

Plot[x^x, {x, 0, 1}]

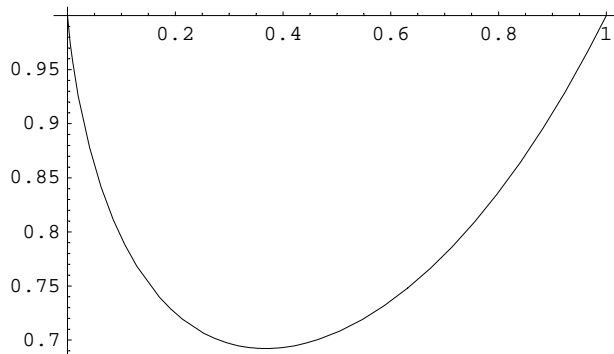

Out[215]=

- Graphics -

In[216]:=

Limit[x^x, x → 0]

Out[216]=

1

Sums and Series

The Command `Sum[f,{i,imax}]` evaluates the sum $\sum_{i=1}^{imax} f$

The Command `Sum[f, {i, imin, imax, di}]` starts with `imin` and uses steps `di`

The Command `Sum[f,{i,imin,imax},{j,jmin,jmax},...]` evaluates the multiple sum $\sum_{i=imin}^{imax} \sum_{j=jmin}^{jmax} \dots f$

In[217]:=

Sum[i², {i, 1, 20}]

Out[217]=

2870

In[218]:=

Sum[i³, {i, 1, n}]

Out[218]=

$\frac{1}{4} n^2 (1 + n)^2$

In[219]:=

$\sum_{n=1}^{\infty} \frac{1}{n^4}$

Out[219]=

$\frac{\pi^4}{90}$

In[220]:=

Sum[i, {i, 4, 10, 3}]

Out[220]=

21

In[221]:=

$$\sum_{i=1}^4 \sum_{j=1}^3 (i * j)$$

Out[221]=

60

In[222]:=

$$\sum_{k=1}^{\infty} \frac{\text{Sin}[k]}{k}$$

Out[222]=

$$-\frac{1}{2} i (\text{Log}[1 - e^{-i}] - \text{Log}[1 - e^i])$$

In[223]:=

ComplexExpand[%]

Out[223]=

$$\text{ArcTan}\left[\frac{\text{Sin}[1]}{1 - \text{Cos}[1]}\right]$$

In[224]:=

N[%, 20]

Out[224]=

1.0707963267948966192

In[225]:=

$$\text{N}\left[\sum_{k=1}^{100} \frac{\text{Sin}[k]}{k}, 20\right]$$

Out[225]=

1.0604289384010621281

In[226]:=

```
v[n_] := N[Sum[Sin[k], {k, 1, n}]/n];
pt = Table[{j, v[j]}, {j, 1, 2000}];
ListPlot[pt]
```

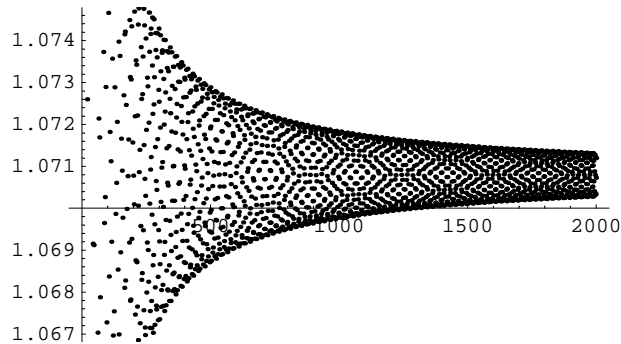

Out[228]=

- Graphics -

The Command `Series[f, {x, x0, n}]` generates a power series expansion for f about the point $x = x_0$ to order $(x - x_0)^n$

In[229]:=

```
Series[Log[1 + x], {x, 0, 7}]
```

Out[229]=

$$x - \frac{x^2}{2} + \frac{x^3}{3} - \frac{x^4}{4} + \frac{x^5}{5} - \frac{x^6}{6} + \frac{x^7}{7} + O[x]^8$$

In[230]:=

```
Clear[f]
```

In[231]:=

```
Series[f[x], {x, 0, 5}]
```

Out[231]=

$$f[0] + f'[0] x + \frac{1}{2} f''[0] x^2 + \frac{1}{6} f^{(3)}[0] x^3 + \frac{1}{24} f^{(4)}[0] x^4 + \frac{1}{120} f^{(5)}[0] x^5 + O[x]^6$$

Vectors and Matrices

Vectors and matrices in Mathematica are simply represented by lists and by lists of lists, respectively. The listed operations are self-explanatory

```
In[232]:=
```

```
v = {3, 2, -1}
```

```
Out[232]=
```

```
{3, 2, -1}
```

```
In[233]:=
```

```
w = {1, 0, 3}
```

```
Out[233]=
```

```
{1, 0, 3}
```

```
In[234]:=
```

```
v + w
```

```
Out[234]=
```

```
{4, 2, 2}
```

```
In[235]:=
```

```
Dot[v, w]
```

```
Out[235]=
```

```
0
```

```
In[236]:=
```

```
v . w
```

```
Out[236]=
```

```
0
```

```
In[237]:=
```

```
Cross[v, w]
```

```
Out[237]=
```

```
{6, -10, -2}
```

```
In[238]:=
```

```
v × w
```

```
Out[238]=
```

```
{6, -10, -2}
```

```
In[239]:=
```

```
c = {{2, 0, 0}, {5, 1, -2}, {3, -2, 1}}
```

```
Out[239]=
```

```
{{2, 0, 0}, {5, 1, -2}, {3, -2, 1}}
```



```
In[240]:=
```

```
c // MatrixForm
```

```
Out[240]//MatrixForm=
```

$$\begin{pmatrix} 2 & 0 & 0 \\ 5 & 1 & -2 \\ 3 & -2 & 1 \end{pmatrix}$$

```
In[241]:=
```

```
c[[2]]
```

```
Out[241]=
```

```
{5, 1, -2}
```

```
In[242]:=
```

```
c[[3, 2]]
```

```
Out[242]=
```

```
-2
```

```
In[243]:=
```

```
d = 3 * c
```

```
Out[243]=
```

```
{{6, 0, 0}, {15, 3, -6}, {9, -6, 3}}
```

```
In[244]:=
```

```
MatrixForm[d]
```

```
Out[244]//MatrixForm=
```

$$\begin{pmatrix} 6 & 0 & 0 \\ 15 & 3 & -6 \\ 9 & -6 & 3 \end{pmatrix}$$

```
In[245]:=
```

```
Det[d]
```

```
Out[245]=
```

```
-162
```

```
In[246]:=
```

$$\mathbf{a} = \begin{pmatrix} 2 & 0 & 0 \\ 0 & 1 & -2 \\ 0 & -2 & 1 \end{pmatrix}$$

```
Out[246]=
```

```
{{2, 0, 0}, {0, 1, -2}, {0, -2, 1}}
```

```
In[247]:=
```

```
a.c
```

```
Out[247]=
```

```
{{4, 0, 0}, {-1, 5, -4}, {-7, -4, 5}}
```

```
In[248]:=
```

```
b = {2, 3, -1}
```

```
Out[248]=
```

```
{2, 3, -1}
```

```
In[249]:=
```

```
RowReduce[a]
```

```
Out[249]=
```

```
{ {1, 0, 0}, {0, 1, 0}, {0, 0, 1} }
```

```
In[250]:=
```

```
MatrixForm[t = Eigenvectors[a]]
```

```
Out[250]//MatrixForm=
```

$$\begin{pmatrix} 0 & -1 & 1 \\ 1 & 0 & 0 \\ 0 & 1 & 1 \end{pmatrix}$$

```
In[251]:=
```

```
Eigenvalues[a]
```

```
Out[251]=
```

```
{3, 2, -1}
```

```
In[252]:=
```

```
LinearSolve[a, b]
```

```
Out[252]=
```

```
{1, -1/3, -5/3}
```

```
In[253]:=
```

```
MatrixForm[p = Transpose[t]]
```

```
Out[253]//MatrixForm=
```

$$\begin{pmatrix} 0 & 1 & 0 \\ -1 & 0 & 1 \\ 1 & 0 & 1 \end{pmatrix}$$

```
In[254]:=
```

```
MatrixForm[pinv = Inverse[p]]
```

```
Out[254]//MatrixForm=
```

$$\begin{pmatrix} 0 & -\frac{1}{2} & \frac{1}{2} \\ 1 & 0 & 0 \\ 0 & \frac{1}{2} & \frac{1}{2} \end{pmatrix}$$

```
In[255]:=
```

```
pinv.a.p // MatrixForm
```

```
Out[255]//MatrixForm=
```

$$\begin{pmatrix} 3 & 0 & 0 \\ 0 & 2 & 0 \\ 0 & 0 & -1 \end{pmatrix}$$

Graphics

To plot a function, use the command `Plot[f,{x,xmin,xmax}]`

`In[256]:=`

```
Plot[4 x3 + 6 x2 - 9 x + 2, {x, -3, 2}]
```

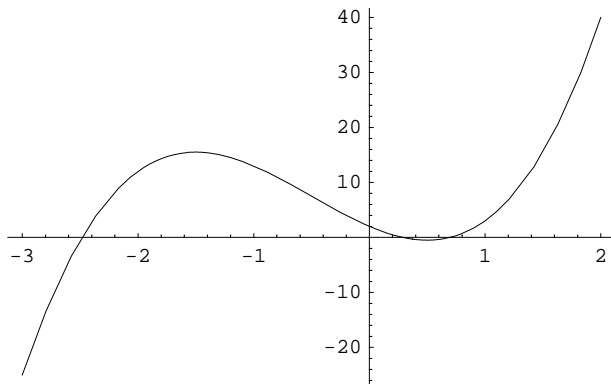

`Out[256]=`

- Graphics -

Some options and directives are available. You can find these options by writing `Options[Plot]`

`In[257]:=`

```
Options[Plot]
```

`Out[257]=`

```
{AspectRatio →  $\frac{1}{\text{GoldenRatio}}$ , Axes → Automatic, AxesLabel → None,
  AxesOrigin → Automatic, AxesStyle → Automatic, Background → Automatic,
  ColorOutput → Automatic, Compiled → True, DefaultColor → Automatic,
  DefaultFont → $DefaultFont, DisplayFunction → $DisplayFunction,
  Epilog → {}, FormatType → $FormatType, Frame → False, FrameLabel → None,
  FrameStyle → Automatic, FrameTicks → Automatic, GridLines → None,
  ImageSize → Automatic, MaxBend → 10., PlotDivision → 30.,
  PlotLabel → None, PlotPoints → 25, PlotRange → Automatic,
  PlotRegion → Automatic, PlotStyle → Automatic, Prolog → {},
  RotateLabel → True, TextStyle → $TextStyle, Ticks → Automatic}
```

Here are some applications of these options. Try to change the values of the options and see the effect

`In[258]:=`

```
Clear [g, h]
```

`In[259]:=`

```
g[x_] = 12 x2 + 12 x - 9;
h[x_] = 24 x + 12;
```

```
In[261]:=
```

```
g1 = Plot[g[x], {x, -3, 2}, PlotStyle -> Dashing[{.01, .02, .03}]]
```

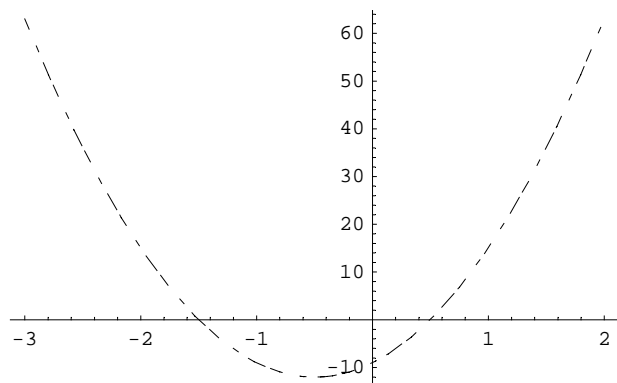

```
Out[261]=
```

```
- Graphics -
```

```
In[262]:=
```

```
g2 = Plot[g[x], {x, -3, 2}, PlotStyle -> GrayLevel[.7]]
```

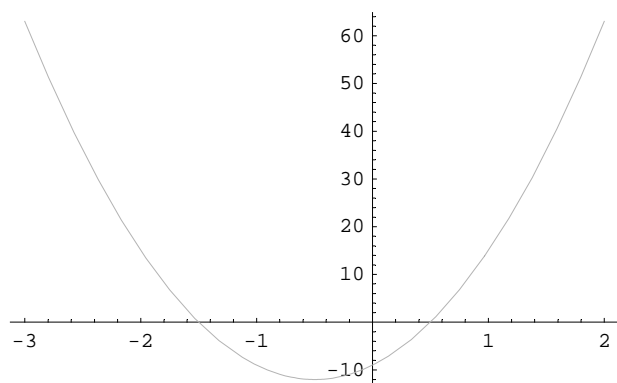

```
Out[262]=
```

```
- Graphics -
```

```
In[263]:=
```

```
h1 = Plot[h[x], {x, -3, 2}, PlotStyle -> RGBColor[.1, .7, .3]]
```

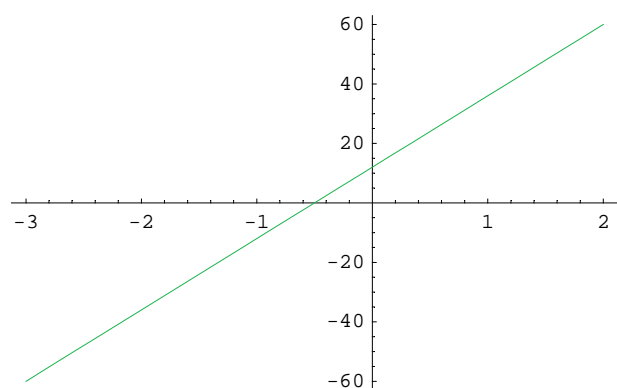

```
Out[263]=
```

```
- Graphics -
```

The command `Show[g1, g2, ..., options]` shows several plots combined

In[264]:=

```
Show[g1, h1, PlotLabel -> "Test of Combined Graphs"]
```

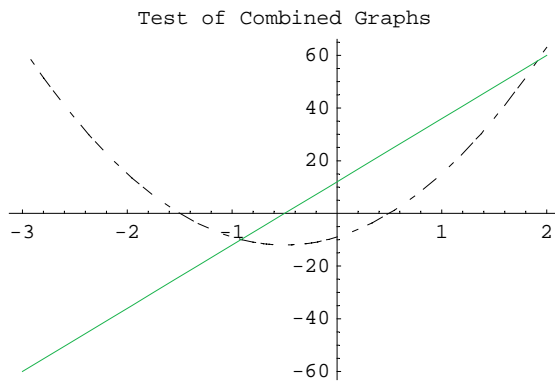

Out[264]=

- Graphics -

In[265]:=

```
Show[g1, GridLines -> {{-2, 0, 1}, Automatic},  
Frame -> True, AxesLabel -> {"x-axis", "y-axis"}]
```

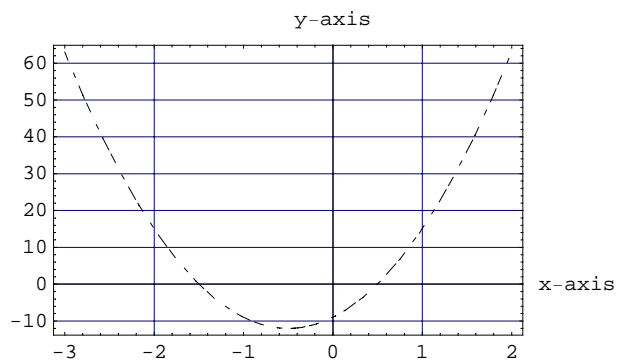

Out[265]=

- Graphics -

In[266]:=

```
Plot[Sin[x], {x, -π, π},  
Ticks -> {Automatic, {-1, -.8, 0, .5, 1}}, PlotStyle -> RGBColor[0, 0, 1]]
```

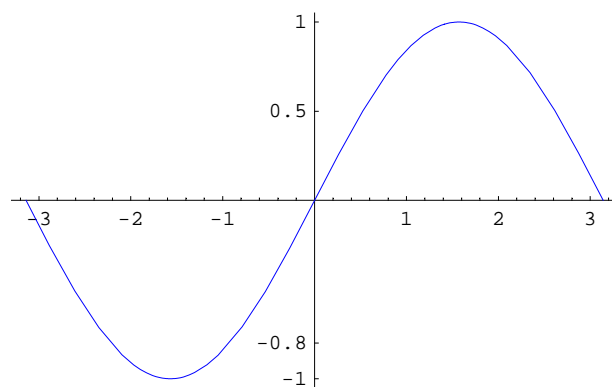

Out[266]=

- Graphics -

In[267]:=

```
Plot[Sin[x], {x, -π, π}, PlotRange → {{-π, 3/2 π}, {-2, 1}}
```

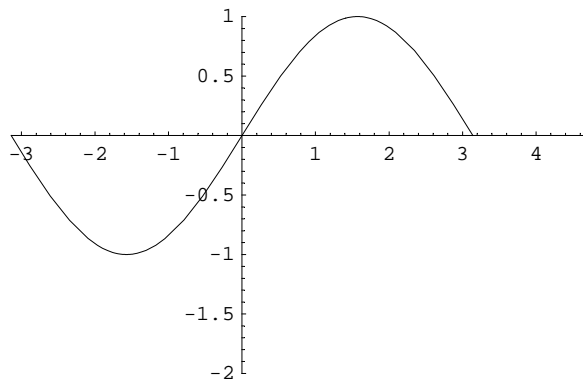

Out[267]=

- Graphics -

In[268]:=

```
Plot[{Sin[x], Sin[2 x], Sin[x/2]}, {x, 0, 4 π}, PlotStyle →
  {GrayLevel[0.4], {RGBColor[1, 0, 0], Dashing[{0.02]}}, RGBColor[0, 1, 0]}
```

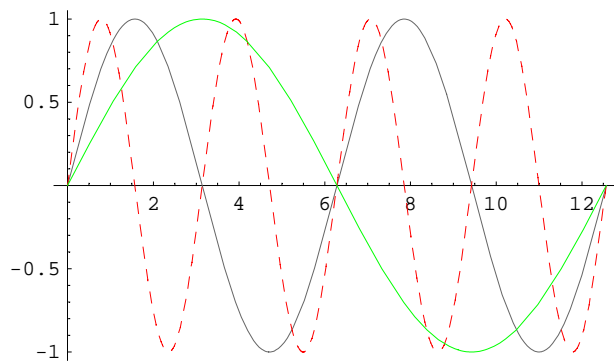

Out[268]=

- Graphics -

In[269]:=

```
circ = Plot[{1 + √(9 - (x - 2)²), 1 - √(9 - (x - 2)²)}, {x, -1, 5}]
```

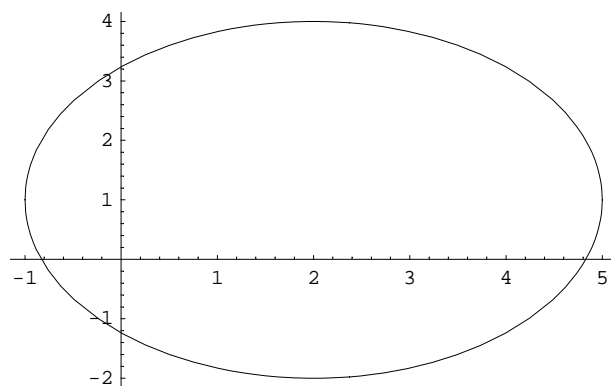

Out[269]=

- Graphics -

```
In[270]:= Show[circ, AspectRatio -> 1]
```

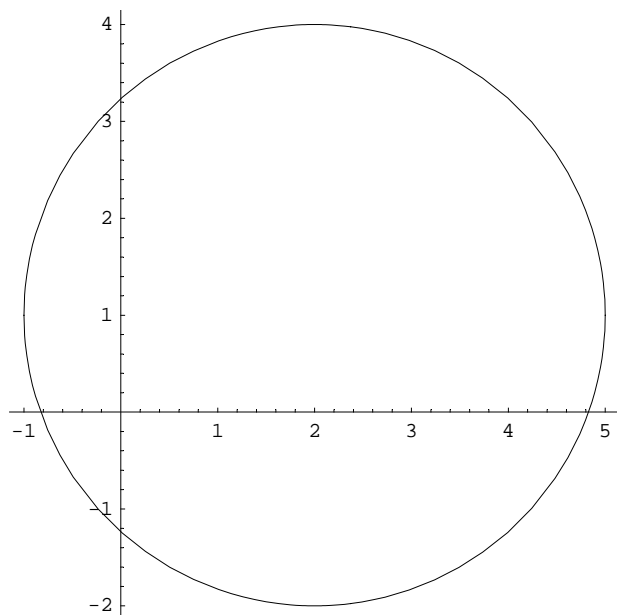

```
Out[270]=  
- Graphics -
```

You can plot the complete circle by using `ImplicitPlot`. You, however, need to load the package ``ImplicitPlot``

```
In[271]:= << Graphics`ImplicitPlot`
```

```
In[272]:= ImplicitPlot[(x - 2)^2 + (y - 1)^2 == 9, {x, -5, 5}]
```

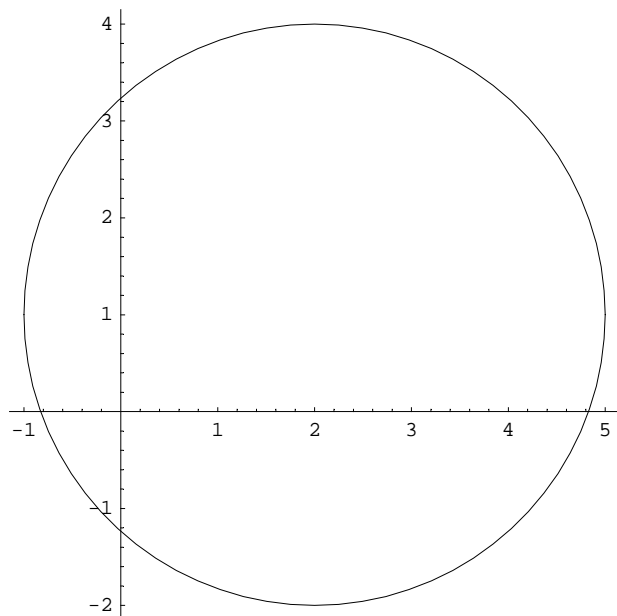

```
Out[272]=  
- Graphics -
```

Piecewise Functions

```
In[273]:=
```

```
Clear[f, t]
```

```
In[274]:=
```

```
f[x_] := Sin[x] /; 0 ≤ x <  $\frac{\pi}{2}$ 
```

```
f[x_] := 1 /;  $\frac{\pi}{2}$  ≤ x <  $\frac{3\pi}{2}$ 
```

```
f[x_] := -Sin[x] /;  $\frac{3\pi}{2}$  ≤ x < 2π
```

```
f[x_] := f[x - 2π] /; x ≥ 2π
```

```
In[278]:=
```

```
Plot[f[x], {x, 0, 5π}, PlotRange → {0, 1.5}]
```

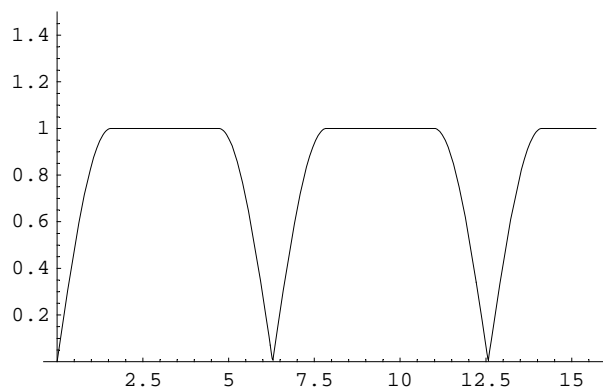

```
Out[278]=
```

```
- Graphics -
```

Parametric Functions

```
In[279]:=
```

```
ParametricPlot[{2 + 3 Cos[t], 1 + 3 Sin[t]}, {t, 0, 2 π}, AspectRatio → 1]
```

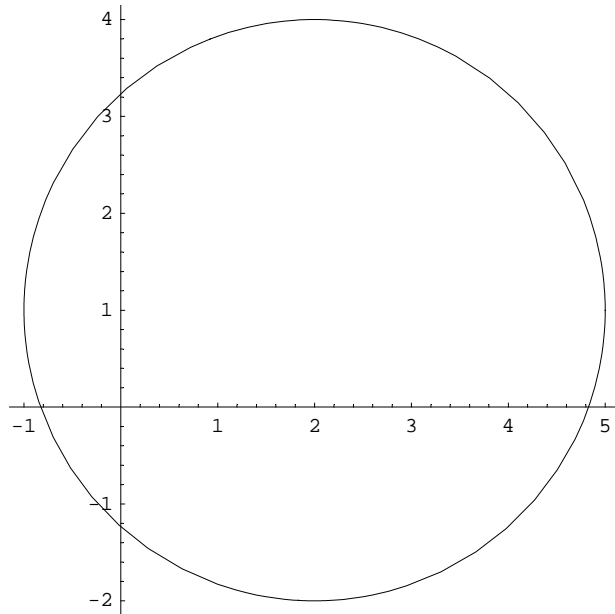

```
Out[279]=
```

```
- Graphics -
```

```
In[280]:=
```

```
Clear[x, y]
```

```
In[281]:=
```

```
x[t_] = t - 2 Sin[t];
```

```
In[282]:=
```

```
y[t_] = 1 - 2 Cos[t];
```

```
In[283]:=
```

```
cycloid = ParametricPlot[{x[t], y[t]}, {t, 0, 8 π}]
```

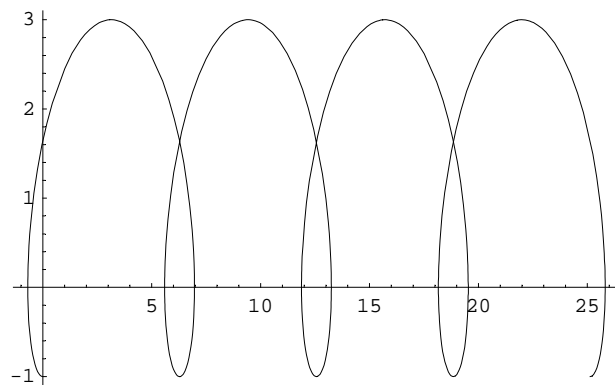

```
Out[283]=
```

```
- Graphics -
```

```
In[284]:=
```

```
Clear[x, y]
```

```
In[285]:=
```

```
x[t_] =  $\frac{3t}{1+t^3}$ ;
```

In[286]:=

$$y[t_] = \frac{3 t^2}{1 + t^3};$$

In[287]:=

```
folium = ParametricPlot[{x[t], y[t]}, {t, -10, 10}, AspectRatio -> 1]
```

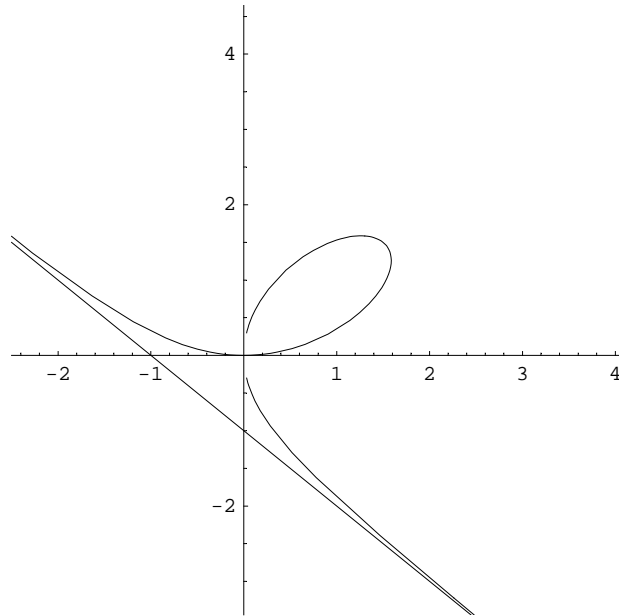

Out[287]=

- Graphics -

In[288]:=

```
Clear[x, y]
```

Polar Graphs

To sketch polar curves, you need to load the package ``Graphics``

In[289]:=

```
<< Graphics`Graphics`
```

In[290]:=

```
p1 = PolarPlot[1 + 2 Sin[t], {t, 0, 2 π}, DisplayFunction -> Identity]
```

Out[290]=

- Graphics -

In[291]:=

```
p2 = PolarPlot[Cos[4 t], {t, 0, 2 π}, DisplayFunction -> Identity]
```

Out[291]=

- Graphics -

In[292]:=

```
p3 = PolarPlot[Cos[ $\frac{8t}{7}$ ], {t, 0, 14  $\pi$ }, DisplayFunction -> Identity]
```

Out[292]=

- Graphics -

In[293]:=

```
p4 = PolarPlot[t Cos[t], {t, - $\frac{19\pi}{2}$ ,  $\frac{19\pi}{2}$ }, DisplayFunction -> Identity]
```

Out[293]=

- Graphics -

In[294]:=

```
p5 = PolarPlot[eCos[t] - 2 Cos[4 t] + Sin[ $\frac{t}{12}$ ]5,  
{t, 0, 24  $\pi$ }, PlotPoints -> 200, DisplayFunction -> Identity]
```

Out[294]=

- Graphics -

In[295]:=

```
p6 = PolarPlot[Cos[t] + Cos[ $\frac{3t}{2}$ ]3, {t, 0, 4  $\pi$ }, DisplayFunction -> Identity]
```

Out[295]=

- Graphics -

The command `GraphicsArray[{{g11, g12, ...}, ...}]` represents a two-dimensional array of graphics objects

In[296]:=

```
Show[GraphicsArray[{{p1, p2}, {p3, p4}, {p5, p6}}]]
```

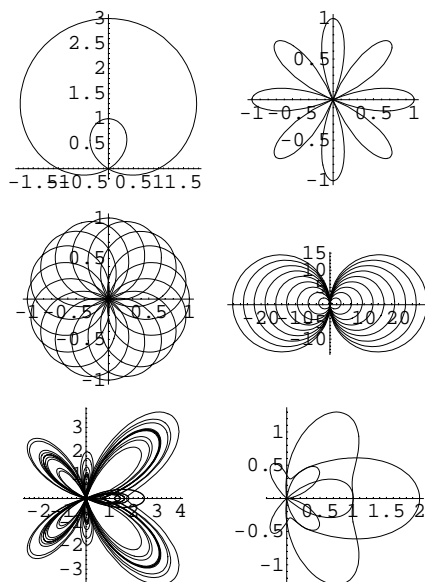

Out[296]=

- GraphicsArray -

3-D Graphics

The command `Plot3D[f,{x,xmin,xmax},{y,ymin,ymax}]` generates a 3-d plot.

The command `Plot3D[{f,s},{x,xmin,xmax},{y,ymin,ymax}]` generates a 3-d plot with shading specified by `s`

```
In[297]:=
```

```
Clear[f]
```

```
In[298]:=
```

```
f[x_, y_] =  $e^{-\left(\frac{x^2}{4} + \frac{y^2}{2}\right)} \cos\left[\frac{x^2}{2} + \frac{4y^2}{4}\right];$ 
```

```
In[299]:=
```

```
Plot3D[f[x, y], {x, -6, 6}, {y, -3, 3}]
```

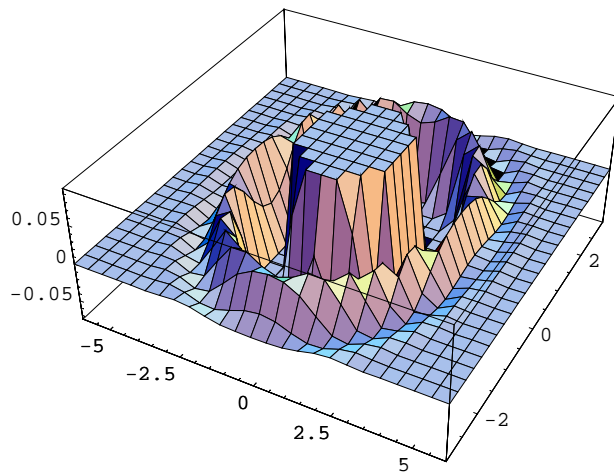

```
Out[299]=
```

```
- SurfaceGraphics -
```

```
In[300]:=
```

```
Plot3D[f[x, y], {x, -6, 6}, {y, -3, 3}, PlotPoints -> 30]
```

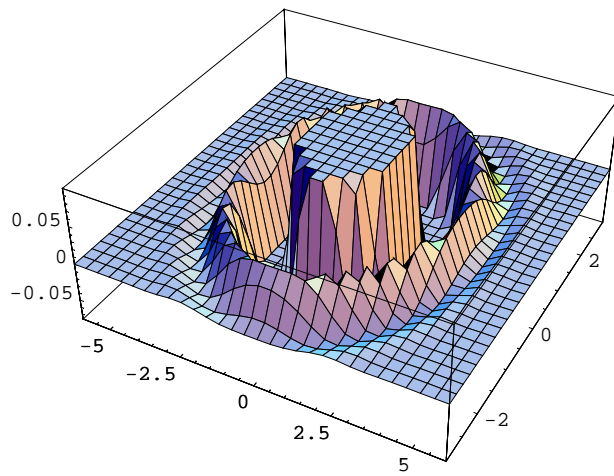

```
Out[300]=
```

```
- SurfaceGraphics -
```

```
In[301]:=
```

```
Plot3D[f[x, y], {x, -6, 6}, {y, -3, 3},  
PlotPoints -> 30, PlotRange -> {{-6, 6}, All, All}]
```

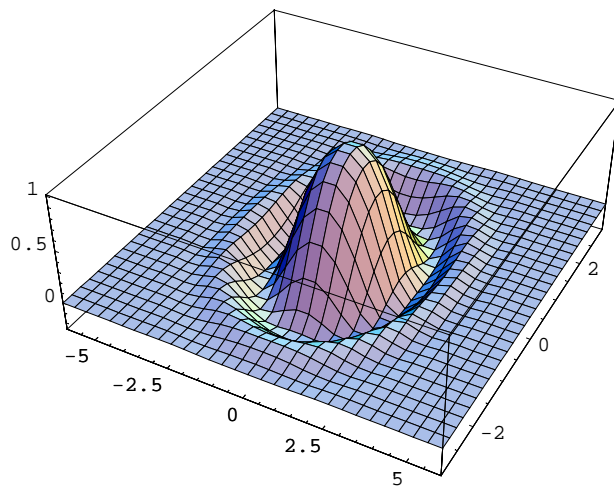

```
Out[301]=
```

```
- SurfaceGraphics -
```

In[302]:=

```
Plot3D[f[x, y], {x, -6, 6}, {y, -3, 3}, PlotPoints → 30, PlotRange → All,
ViewPoint -> {-2.428, -1.870, 1.995}, Boxed → False, BoxRatios → {6, 3, 1}]
```

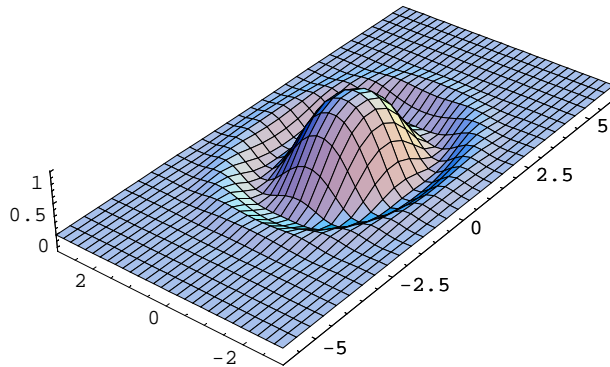

Out[302]=

- SurfaceGraphics -

In[303]:=

```
p1 = Plot3D[Sin[x] eCos[y], {x, 0, 2 π}, {y, 0, 4 π},
PlotPoints → 30, Ticks → None, DisplayFunction → Identity];
```

In[304]:=

```
p2 = Plot3D[Sin[x] eCos[y], {x, 0, 2 π}, {y, 0, 4 π}, PlotPoints → 30,
Ticks → None, DisplayFunction → Identity, Lighting → False];
```

In[305]:=

```
p3 = Plot3D[Sin[x] eCos[y], {x, 0, 2 π}, {y, 0, 4 π}, PlotPoints → 30,
Ticks → None, DisplayFunction → Identity, Shading → False];
```

In[306]:=

```
p4 = Plot3D[{Sin[x] eCos[y], RGBColor[1, 0, 0]}, {x, 0, 2 π},
{y, 0, 4 π}, PlotPoints → 30, Ticks → None, DisplayFunction → Identity];
```

In[307]:=

```
p5 = Plot3D[{Sin[x] eCos[y], RGBColor[0, Abs[Sin[x] Cos[y]], 0]}, {x, 0, 2 π},
{y, 0, 4 π}, PlotPoints → 30, Ticks → None, DisplayFunction → Identity];
```

```
In[308]:= Show[GraphicsArray[{{p1}, {p2, p3}, {p4, p5}}]]
```

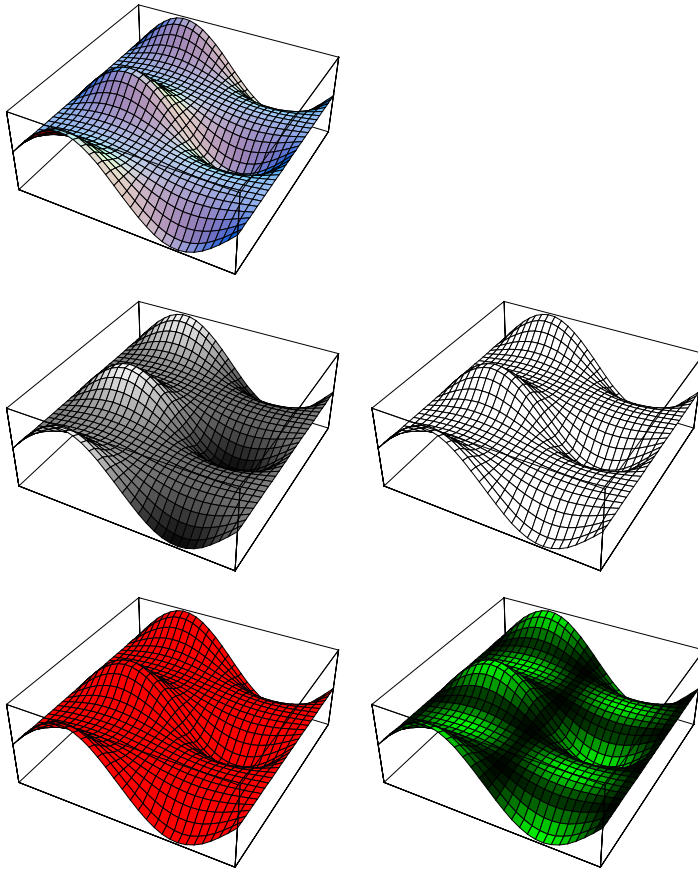

```
Out[308]=  
- GraphicsArray -
```

Level Curves

The command `ContourPlot[f,{x,xmin,xmax},{y,ymin,ymax}]` generates a contour plot.

```
In[309]:= Clear[f]
```

```
In[310]:= f[x_, y_] = Sin[x2 + y2];
```

```
In[311]:=
```

```
g1 = ContourPlot[f[x, y], {x, -2, 2}, {y, -2, 2}]
```

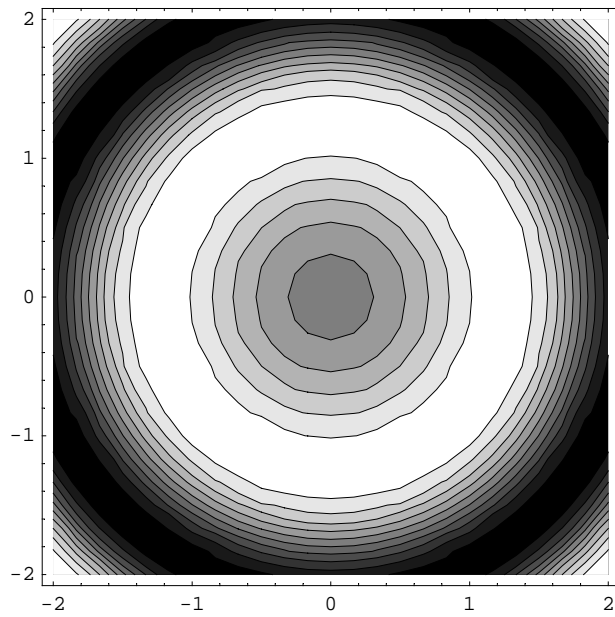

```
Out[311]=
```

```
- ContourGraphics -
```

```
In[312]:=
```

```
g2 = ContourPlot[f[x, y], {x, -2, 2}, {y, -2, 2}, PlotPoints -> 50,  
Contours -> 15, Frame -> False, Axes -> Automatic, AxesOrigin -> {0, 0},  
ContourShading -> False, ContourStyle -> {RGBColor[.9, .2, .3]}]
```

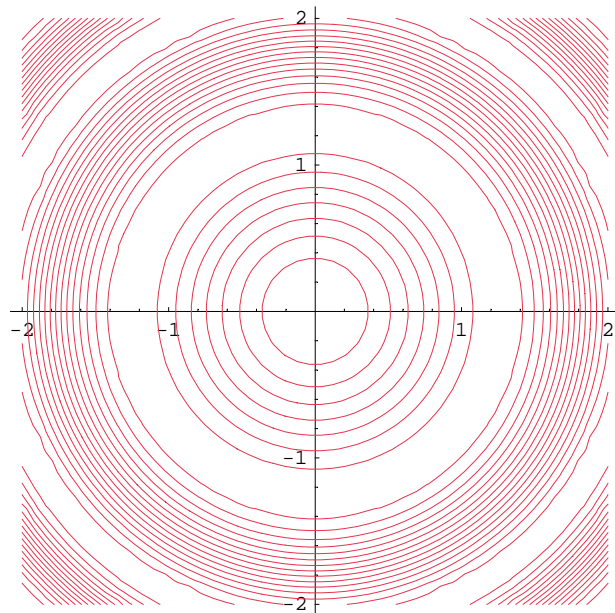

```
Out[312]=
```

```
- ContourGraphics -
```

In[313]:=

```
g3 = Plot3D[f[x, y], {x, -2, 2}, {y, -2, 2}, PlotPoints → 50, Shading → False]
```

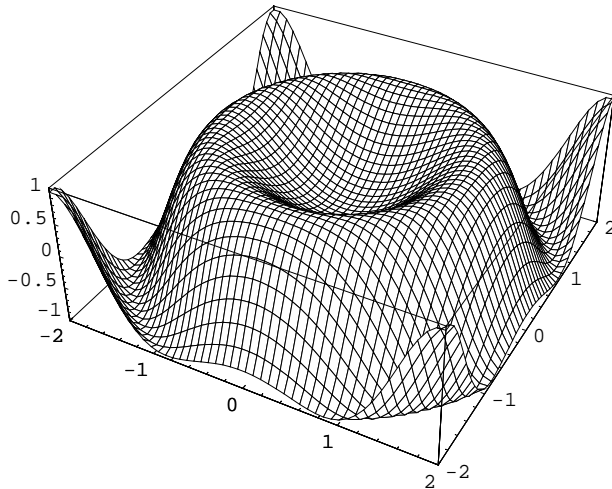

Out[313]=

- SurfaceGraphics -

In[314]:=

```
Show[GraphicsArray[{g2, g3}]]
```

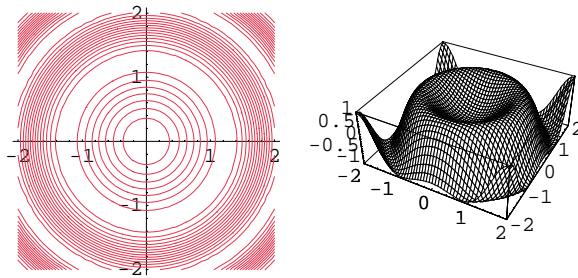

Out[314]=

- GraphicsArray -

In[315]:=

```
Options[ContourPlot]
```

Out[315]=

```
{AspectRatio → 1, Axes → False, AxesLabel → None, AxesOrigin → Automatic,
AxesStyle → Automatic, Background → Automatic, ColorFunction → Automatic,
ColorFunctionScaling → True, ColorOutput → Automatic, Compiled → True,
ContourLines → True, Contours → 10, ContourShading → True,
ContourSmoothing → True, ContourStyle → Automatic, DefaultColor → Automatic,
DefaultFont → $DefaultFont, DisplayFunction → $DisplayFunction,
Epilog → {}, FormatType → $FormatType, Frame → True, FrameLabel → None,
FrameStyle → Automatic, FrameTicks → Automatic, ImageSize → Automatic,
PlotLabel → None, PlotPoints → 25, PlotRange → Automatic, PlotRegion → Automatic,
Prolog → {}, RotateLabel → True, TextStyle → $TextStyle, Ticks → Automatic}
```

The command `ShadowPlot3D[f,{x,xmin,xmax},{y,ymin,ymax}]` generates a plot of and draws a shadow in the x-y plane. You also need to load the package ``Graphics3D``

```
In[316]:=
```

```
<< Graphics`Graphics3D`
```

```
In[317]:=
```

```
ShadowPlot3D[Cos[-x^2 - y - ex2+y2], {x, -1, 1},  
{y, -1, 1}, PlotPoints → 50, ShadowPosition → -1]
```

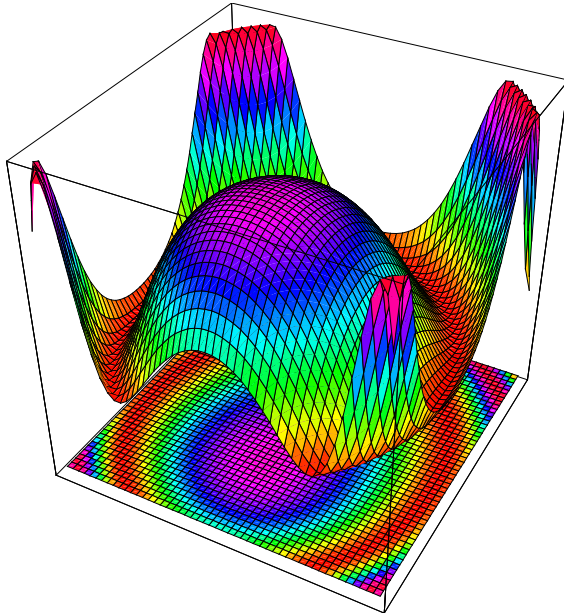

```
Out[317]=
```

```
- Graphics3D -
```

The `ContourPlot3D` command generates a 3-d contour plot of f as a function of x , y , and z . You also need to load the package `ContourPlot3D``

```
In[318]:=
```

```
<< Graphics`ContourPlot3D`
```

In[319]:=

```
g1 = ContourPlot3D[x^2 / 16 + y^2 + z^2 / 4 - 1,
  {x, -4, 4}, {y, -1, 1}, {z, -2, 2}, Contours -> {0, 1}]
```

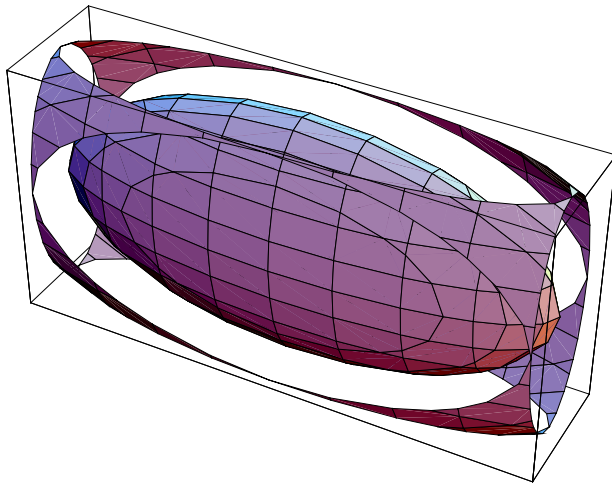

Out[319]=

- Graphics3D -

In[320]:=

```
g2 = ContourPlot3D[x^2 + y^2 - z^2 / 4 - 1, {x, -√5, √5},
  {y, -√5, √5}, {z, -2, 2}, Contours -> {0}, PlotPoints -> {5, 5, 5},
  ViewPoint -> {3.131, 0.993, 1.424}, Axes -> True, Boxed -> False,
  AxesStyle -> {RGBColor[1, 0, 0], Thickness[.02]}, ColorOutput -> RGBColor,
  LightSources -> {{{.4, 0, 1}, RGBColor[.5, .7, .3]}}
```

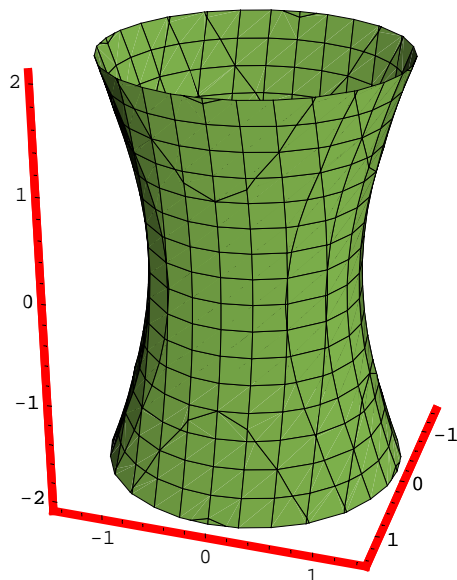

Out[320]=

- Graphics3D -

The **command** **ParametricPlot3D**
D[{x[u,v], y[u,v], z[u,v]}, {u, umin, umax}, {v, vmin, vmax}, {z, ymin, ymax}]

produces a three-dimensional surface parametrized by u and v .
You also need to load the package ``ParametricPlot3D``

```
In[321]:=
```

```
<< Graphics`ParametricPlot3D`
```

```
In[322]:=
```

```
Clear[x, y, z, u, v]
```

```
In[323]:=
```

```
x[u_, v_] = u;
```

```
y[u_, v_] = Cos[v] / u;
```

```
z[u_, v_] = Sin[v] / u;
```

```
ParametricPlot3D[{x[u, v], y[u, v], z[u, v]}, {u, 0.7, 5}, {v, 0, 2  $\pi$ },  
Shading  $\rightarrow$  False, ViewPoint  $\rightarrow$  {2.617, 1.877, 1.311}, PlotPoints  $\rightarrow$  30]
```

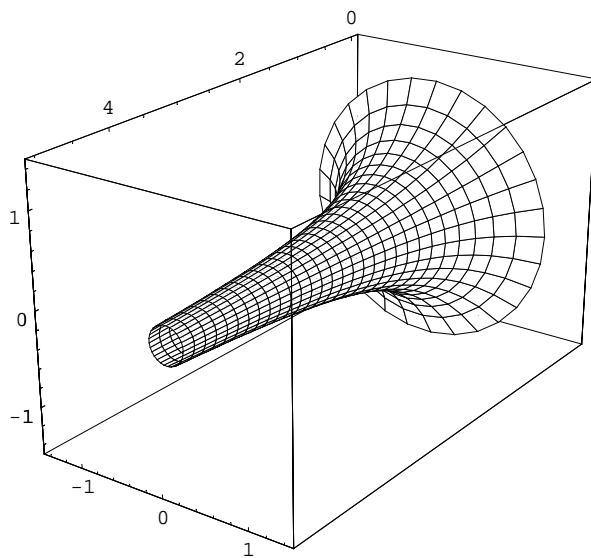

```
Out[326]=
```

```
- Graphics3D -
```

In[327]:=

```
x1[u_, v_] = u v;
y1[u_, v_] = u;
z1[u_, v_] = v^2;
ParametricPlot3D[{x1[u, v], y1[u, v], z1[u, v]}, {u, -2, 2},
{v, -2, 2}, ViewPoint -> {2.086, 2.606, 0.935}, PlotPoints -> 30]
```

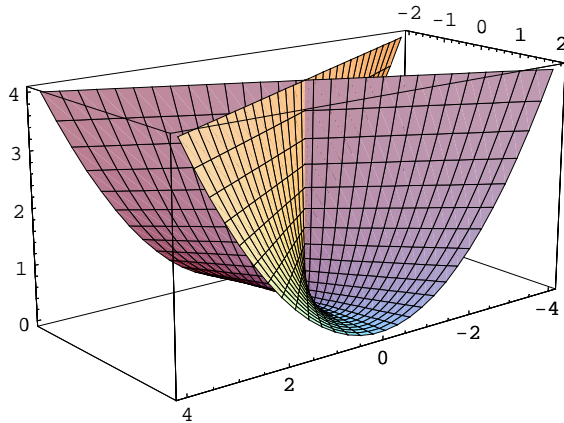

Out[330]=

- Graphics3D -

The following segments load the `VectorAnalysis` package, set the coordinates to Cartesian, calculate the Grad (gradient) of a function, load the `PlotField3D` package, and use the command `PlotVectorField3d` to plot the gradient as a vector field.

In[331]:=

```
<< Calculus`VectorAnalysis`
```

In[332]:=

```
p1 = Plot3D[Cos[4 x^2 + 9 y^2], {x, -1, 1},
{y, -1, 1}, Boxed -> False, PlotPoints -> 35, Shading -> False]
```

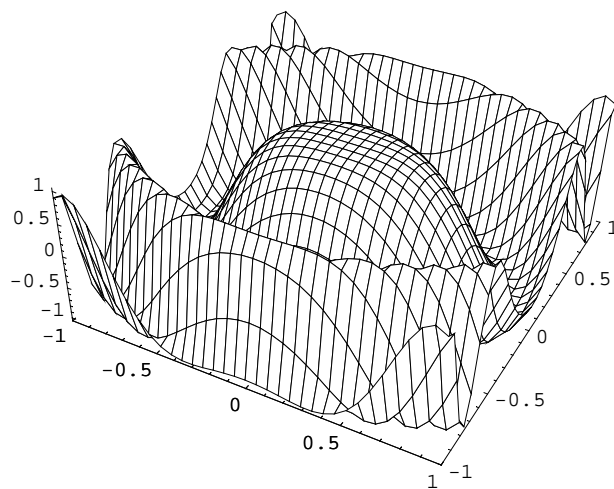

Out[332]=

- SurfaceGraphics -

In[333]:=

```
SetCoordinates[Cartesian[x, y, z]]
```

Out[333]=

```
Cartesian[x, y, z]
```

In[334]:=

```
gw[x_, y_] = Grad[z - Cos[4 x^2 + 9 y^2], Cartesian]
```

Out[334]=

```
{8 x Sin[4 x^2 + 9 y^2], 18 y Sin[4 x^2 + 9 y^2], 1}
```

In[335]:=

```
norm[x_, y_] = gw[x, y] / Sqrt[gw[x, y].gw[x, y]]
```

General::spell1 :

Possible spelling error: new symbol name "norm" is similar to existing symbol "Norm". More...

Out[335]=

$$\left\{ \frac{8 x \sin[4 x^2 + 9 y^2]}{\sqrt{1 + 64 x^2 \sin^2[4 x^2 + 9 y^2] + 324 y^2 \sin^2[4 x^2 + 9 y^2]}}, \frac{18 y \sin[4 x^2 + 9 y^2]}{\sqrt{1 + 64 x^2 \sin^2[4 x^2 + 9 y^2] + 324 y^2 \sin^2[4 x^2 + 9 y^2]}}, \frac{1}{\sqrt{1 + 64 x^2 \sin^2[4 x^2 + 9 y^2] + 324 y^2 \sin^2[4 x^2 + 9 y^2]}} \right\}$$

In[336]:=

```
<< Graphics`PlotField3D`
```

In[337]:=

```
p2 = PlotVectorField3D[norm[x, y],
  {x, -1, 1}, {y, -1, 1}, {z, -1, 1}, VectorHeads -> True]
```

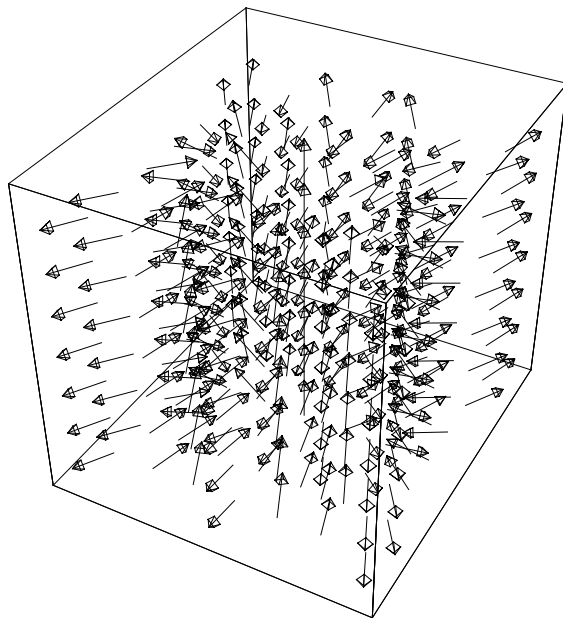

Out[337]=

```
- Graphics3D -
```

```
In[338]:=
  Show[p1, p2]
```

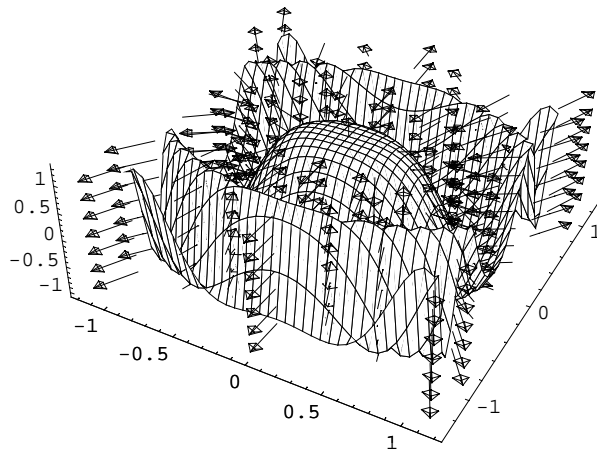

```
Out[338]=
  - Graphics3D -
```

The following few lines generate an animation of the tangent line to a function. You should read more under HELP about Modules and Do loops. Change the value of step to 0.5 and animate the output cell by first highlighting it and then pressing Ctrl+y

```
In[339]:=
  f[x_] = x Sin[x]
```

```
Out[339]=
  x Sin[x]
```

```
In[340]:=
  plotf = Plot[f[x], {x, 0, 4 π}, PlotStyle → RGBColor[0, 0, 1]]
```

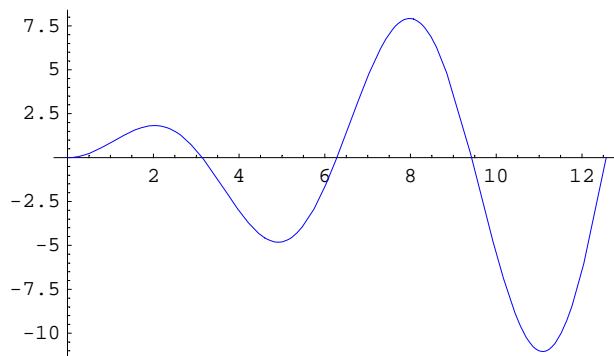

```
Out[340]=
  - Graphics -
```

In[341]:=

```
t[x0_] := Module[{eq, peq}, eq = f'[x0] (x - x0) + f[x0];
  peq = Plot[eq, {x, x0 - 1, x0 + 1}, PlotStyle ->
    {RGBColor[1, 1, 0], Thickness[0.01]}, DisplayFunction -> Identity];
  step = 6
  Do[Show[plotf, t[n]], {n, 0, 12, step}]
```

Out[342]=

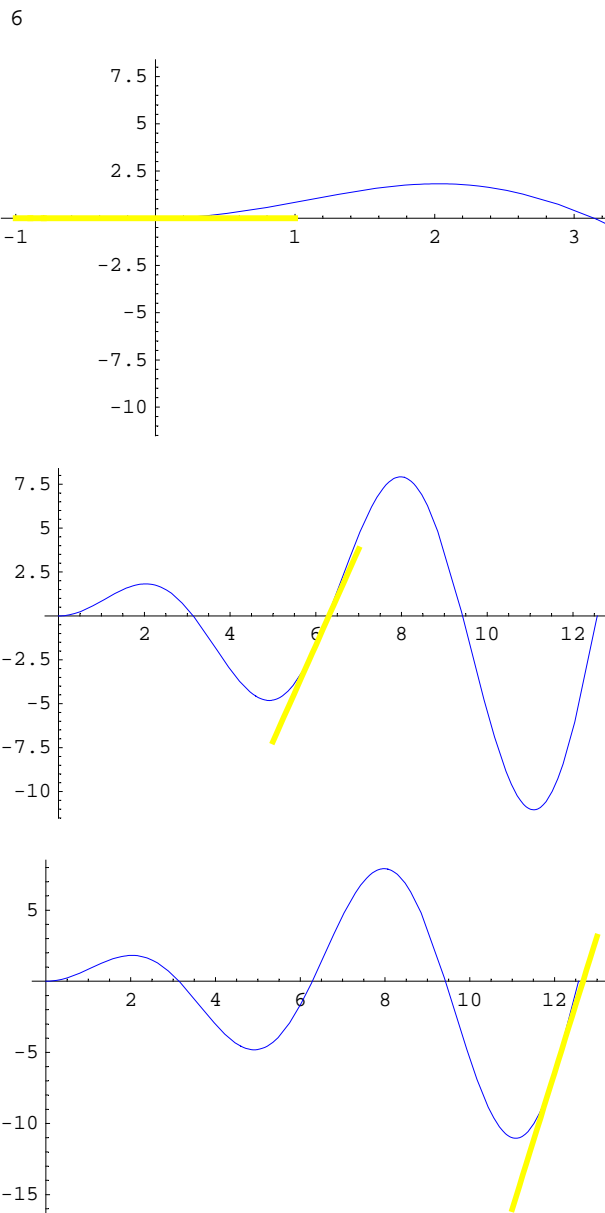

References:

1. Wolfram Research, The *Mathematica* Book, Fourth Edition, Wolfram Media, 1999.
2. Wolfram Research, Standard Add-On Packages, Fourth Edition, Wolfram Media, 1999.
3. Martha Abell and James Braselton, *Mathematica* by Example, Second Edition, 1997.