

COE 444 - Internetwork Design and Management
Fall 2004 (Term 041)

Homework 3

Date: Monday, October 4, 2004

Q1. For the internetwork given below, assign network addresses to all routers interfaces (i.e. IFx) and to all subnets assuming that all of them are **Class C** networks.

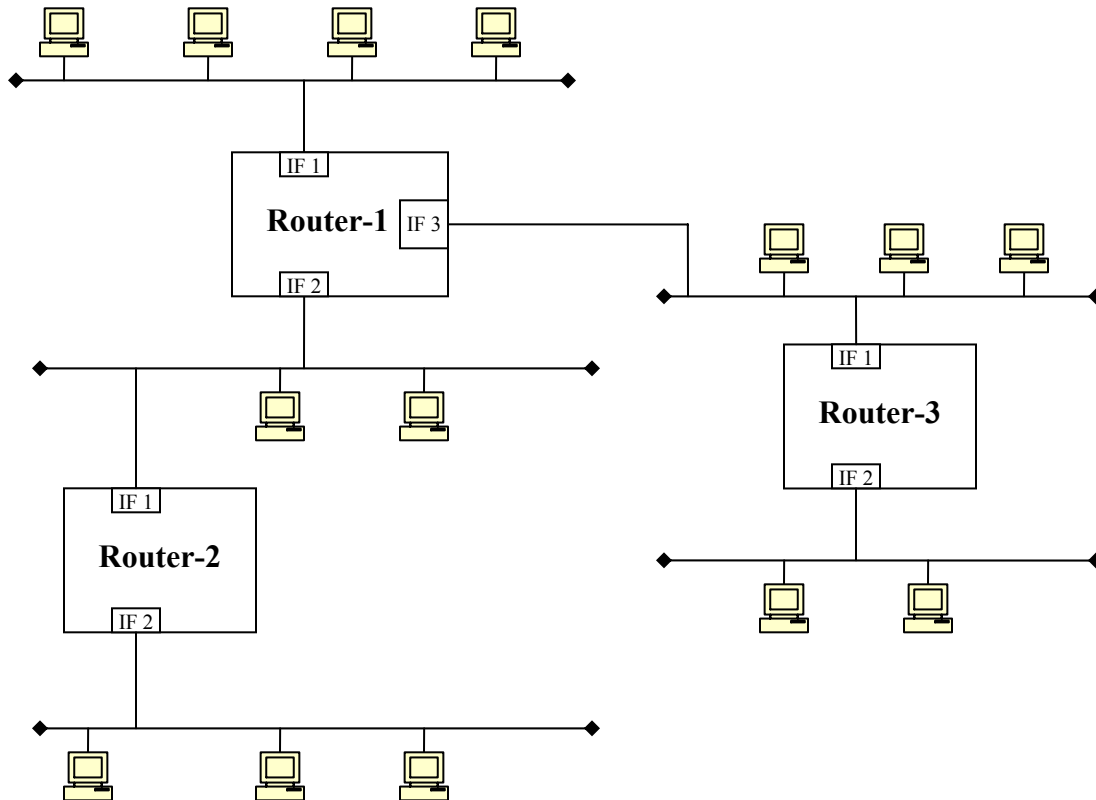

Q2. Flooding can be used to determine the minimum-hop route. Can it be used to determine the minimum delay route?

Q3. Consider a system using flooding with a hop counter. Suppose that the hop counter is originally set to the “diameter” of the network. When the hop count reaches zero, the packet is discarded except at its destination. Does this always ensure that a packet will reach its destination if there exists at least one operable path? Why or why not?

Q4. Describe how source routing bridges avoid looping when an “all-routes broadcast” request is transmitted.

Q5. Compare and discuss transparent bridges and source routing bridges.

Q6. Compare and discuss bridges vs. routers.

Q7. State the type of metrics used in each one of these routing protocols: RIP, OSPF, and BGP? What is the maximum number of hops between a source and destination in RIP and why this number can not be exceeded?

Q8. Define the address aggregation concept. Give an example on how to aggregate three different addresses. Identify one reason for using address aggregation.