**Problem Solutions to Problems Marked With a * in
Logic Computer Design Fundamentals, Ed. 2**

CHAPTER 2

© 2000 by Prentice-Hall, Inc.

2-1.

a) $\overline{XYZ} = \overline{X} + \overline{Y} + \overline{Z}$

Verification of DeMorgan's Theorem

X	Y	Z	XYZ	\overline{XYZ}	$\overline{X} + \overline{Y} + \overline{Z}$
0	0	0	0	1	1
0	0	1	0	1	1
0	1	0	0	1	1
0	1	1	0	1	1
1	0	0	0	1	1
1	0	1	0	1	1
1	1	0	0	1	1
1	1	1	1	0	0

b) $X + YZ = (X + Y) \cdot (X + Z)$

The Second Distributive Law

X	Y	Z	YZ	X+YZ	X+Y	X+Z	(X+Y)(X+Z)
0	0	0	0	0	0	0	0
0	0	1	0	0	0	1	0
0	1	0	0	0	1	0	0
0	1	1	1	1	1	1	1
1	0	0	0	1	1	1	1
1	0	1	0	1	1	1	1
1	1	0	0	1	1	1	1
1	1	1	1	1	1	1	1

c) $\overline{X}Y + \overline{Y}Z + X\overline{Z} = \overline{X}Y + Y\overline{Z} + X\overline{Z}$

X	Y	Z	$\overline{X}Y$	$\overline{Y}Z$	$X\overline{Z}$	$\overline{X}Y + \overline{Y}Z + X\overline{Z}$	$X\overline{Y}$	$Y\overline{Z}$	$\overline{X}Z$	$X\overline{Y} + Y\overline{Z} + \overline{X}Z$
0	0	0	0	0	0	0	0	0	0	0
0	0	1	0	1	0	1	0	0	1	1
0	1	0	1	0	0	1	0	1	0	1
0	1	1	1	0	0	1	0	0	1	1
1	0	0	0	0	1	1	1	0	0	1
1	0	1	0	1	0	1	1	0	0	1
1	1	0	0	0	1	1	0	1	0	1
1	1	1	0	0	0	0	0	0	0	0

2-2.

a) $\overline{X}\overline{Y} + \overline{X}Y + XY = \overline{X} + Y$
 $= (\overline{X}Y + \overline{X}\overline{Y}) + (X\overline{Y} + XY)$
 $= \overline{X}(Y + \overline{Y}) + Y(X + \overline{X}) +$
 $= \overline{X} + Y$

Problem Solutions – Chapter 2

- b) $\overline{A}B + \overline{B}C + AB + \overline{B}C = 1$
 $= (\overline{A}B + AB) + (\overline{B}C + \overline{B}C)$
 $= B(A + \overline{A}) + \overline{B}(C + \overline{C})$
 $= B + \overline{B}$
 $= 1$
- c) $Y + \overline{X}Z + X\overline{Y} = X + Y + Z$
 $= Y + X\overline{Y} + \overline{X}Z$
 $= (Y + X)(Y + \overline{Y}) + \overline{X}Z$
 $= Y + X + \overline{X}Z$
 $= Y + (X + \overline{X})(X + Z)$
 $= X + Y + Z$
- d) $\overline{X}\overline{Y} + \overline{Y}Z + XZ + XY + Y\overline{Z} = \overline{X}\overline{Y} + XZ + Y\overline{Z}$
 $= \overline{X}\overline{Y} + \overline{Y}Z(X + \overline{X}) + XZ + XY + Y\overline{Z}$
 $= \overline{X}\overline{Y} + X\overline{Y}Z + \overline{X}\overline{Y}Z + XZ + XY + Y\overline{Z}$
 $= \overline{X}\overline{Y}(1 + Z) + X\overline{Y}Z + XZ + XY + Y\overline{Z}$
 $= \overline{X}\overline{Y} + XZ(1 + \overline{Y}) + XY + Y\overline{Z}$
 $= \overline{X}\overline{Y} + XZ + XY(Z + \overline{Z}) + Y\overline{Z}$
 $= \overline{X}\overline{Y} + XZ + XYZ + Y\overline{Z}(1 + X)$
 $= \overline{X}\overline{Y} + XZ(1 + Y) + Y\overline{Z}$
 $= \overline{X}\overline{Y} + XZ + Y\overline{Z}$

2-7.

- a) $\overline{X}\overline{Y} + XYZ + \overline{X}Y = \overline{X} + XYZ = (\overline{X} + XY)(\overline{X} + Z)$
 $= (\overline{X} + X)(\overline{X} + Y)(\overline{X} + Z) = (\overline{X} + Y)(\overline{X} + Z) = \overline{X} + YZ$
- b) $X + Y(Z + \overline{X}\overline{Z}) = X + YZ + \overline{X}Y\overline{Z} = X + (YZ + \overline{X})(YZ + Y\overline{Z}) = X + Y(\overline{X} + YZ)$
 $= X + \overline{X}Y + YZ = (X + \overline{X})(X + Y) + YZ = X + Y + YZ = X + Y$
- c) $\overline{W}X(\overline{Z} + \overline{Y}Z) + X(W + \overline{W}YZ) = \overline{W}X\overline{Z} + \overline{W}X\overline{Y}Z + WX + \overline{W}XYZ$
 $= WX + \overline{W}X\overline{Z} + \overline{W}XZ = WX + \overline{W}X = X$
- d) $(AB + \overline{A}\overline{B})(CD + \overline{C}\overline{D}) + \overline{A}\overline{C}$
 $= AB\overline{C}\overline{D} + ABCD + \overline{A}\overline{B}\overline{C}\overline{D} + \overline{A}\overline{B}CD + \overline{A} + \overline{C}$
 $= \overline{A} + \overline{C} + ABCD$
 $= \overline{A} + \overline{C} + A(BCD)$
 $= \overline{A} + \overline{C} + BCD$
 $= \overline{A} + \overline{C} + C(BD)$
 $= \overline{A} + \overline{C} + BD$

2-9.

- a) $\overline{F} = (\overline{A} + B)(A + \overline{B})$
- b) $\overline{F} = ((V + \overline{W})\overline{X} + \overline{Y})Z$
- c) $\overline{F} = [\overline{W} + \overline{X} + (Y + \overline{Z})(\overline{Y} + Z)][W + X + Y\overline{Z} + \overline{Y}Z]$
- d) $\overline{F} = \overline{A}\overline{B}\overline{C} + (A + B)\overline{C} + \overline{A}(B + C)$

2-10.

Truth Tables a, b, c

X	Y	Z	a	A	B	C	b	W	X	Y	Z	c
0	0	0	0	0	0	0	1	0	0	0	0	0
0	0	1	0	0	0	1	1	0	0	0	1	0
0	1	0	0	0	1	0	0	0	0	1	0	1
0	1	1	1	0	1	1	1	0	0	1	1	0
1	0	0	0	1	0	0	0	0	1	0	0	0
1	0	1	1	1	0	1	0	0	1	0	1	0
1	1	0	1	1	1	0	0	0	1	1	0	1
1	1	1	1	1	1	1	1	0	1	1	1	0
								1	0	0	0	0
								1	0	0	1	0
								1	0	1	0	1
								1	0	1	1	0
								1	1	0	0	1
								1	1	0	1	1
								1	1	1	0	1
								1	1	1	1	1

- a) Sum of Minterms: $\bar{X}YZ + X\bar{Y}Z + XY\bar{Z} + XYZ$
 Product of Maxterms: $(X + Y + Z)(X + Y + \bar{Z})(X + \bar{Y} + Z)(\bar{X} + Y + Z)$
- b) Sum of Minterms: $\bar{A}\bar{B}\bar{C} + \bar{A}\bar{B}C + \bar{A}B\bar{C} + ABC$
 Product of Maxterms: $(A + \bar{B} + C)(\bar{A} + B + C)(\bar{A} + B + \bar{C})(\bar{A} + \bar{B} + C)$
- c) Sum of Minterms: $\bar{W}\bar{X}Y\bar{Z} + \bar{W}XY\bar{Z} + W\bar{X}Y\bar{Z} + WX\bar{Y}\bar{Z} + WX\bar{Y}Z + WX\bar{Y}Z + WXYZ + WXYZ$
 Product of Maxterms: $(W + X + Y + Z)(W + X + Y + \bar{Z})(W + X + \bar{Y} + \bar{Z})(W + \bar{X} + Y + Z)(W + \bar{X} + Y + \bar{Z})(W + \bar{X} + \bar{Y} + \bar{Z})(\bar{W} + X + Y + Z)(\bar{W} + X + Y + \bar{Z})(\bar{W} + X + \bar{Y} + \bar{Z})$

2-12.

- a) $(AB + C)(B + \bar{C}D) = AB + BC + AB\bar{C}D = AB + BC$ s.o.p.
 $= B(A + C)$ p.o.s.
- b) $\bar{X} + X((X + \bar{Y})(Y + \bar{Z})) = (\bar{X} + X)(\bar{X} + (X + \bar{Y})(Y + \bar{Z}))$
 $= (\bar{X} + X + \bar{Y})(\bar{X} + Y + \bar{Z}) = \bar{X} + Y + \bar{Z}$ s.o.p. and p.o.s.
- c) $(A + B\bar{C} + CD)(\bar{B} + EF) = (A + B + C)(A + B + D)(A + \bar{C} + D)(\bar{B} + E)(\bar{B} + F)$ p.o.s.
 $(A + B\bar{C} + CD)(\bar{B} + EF) = A(\bar{B} + EF) + B\bar{C}(\bar{B} + EF) + CD(\bar{B} + EF)$
 $= A\bar{B} + AEF + B\bar{C}EF + \bar{B}CD + CDEF$ s.o.p.

2-15.

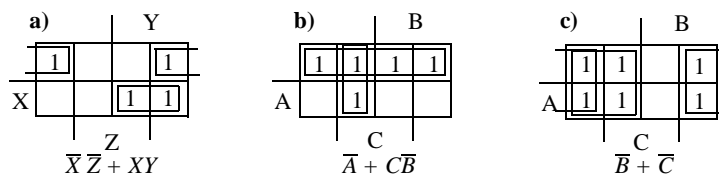

Problem Solutions – Chapter 2

2-18.

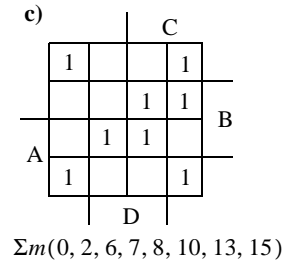
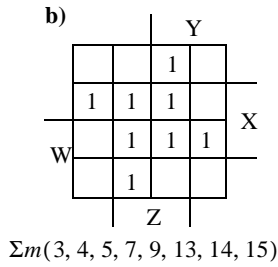
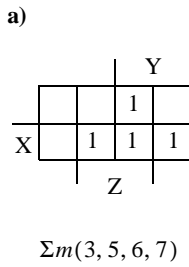

2-19.

Using K-maps:

- a) Prime = $XZ, WX, \bar{X}\bar{Z}, W\bar{Z}$ b) Prime = $CD, AC, \bar{B}\bar{D}, \bar{A}BD, \bar{B}C$ c) Prime = $AB, AC, AD, B\bar{C}, \bar{B}D, \bar{C}D$
 Essential = $XZ, \bar{X}\bar{Z}$ Essential = $AC, \bar{B}\bar{D}, \bar{A}BD$ Essential = $AC, B\bar{C}, \bar{B}D$

2-22.

Using K-maps:

- a) s.o.p. $CD + AC + \bar{B}D$ b) s.o.p. $\bar{A}\bar{C} + \bar{B}\bar{D} + A\bar{D}$ c) s.o.p. $\bar{B}\bar{D} + \bar{A}BD + (\bar{A}BC \text{ or } \bar{A}\bar{C}\bar{D})$
 p.o.s. $(\bar{C} + D)(A + D)(A + \bar{B} + C)$ p.o.s. $(\bar{C} + \bar{D})(\bar{A} + \bar{D})(A + \bar{B} + \bar{C})$ p.o.s. $(\bar{A} + \bar{B})(B + \bar{D})(\bar{B} + C + D)$

2-25.

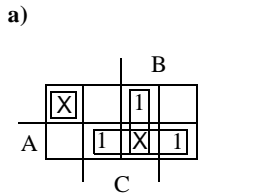

Primes = $AB, AC, BC, \bar{A}\bar{B}\bar{C}$
 Essential = AB, AC, BC
 $F = AB + AC + BC$

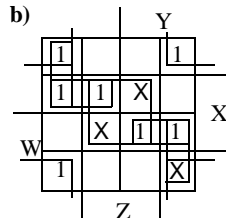

Primes = $\bar{X}\bar{Z}, XZ, \bar{W}X\bar{Y}, WXY, \bar{W}\bar{Y}\bar{Z}, WY\bar{Z}$
 Essential = $\bar{X}\bar{Z}$
 $F = \bar{X}\bar{Z} + \bar{W}X\bar{Y} + WXY$

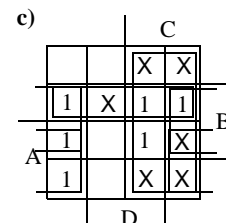

Primes = $\bar{A}B, C, A\bar{D}, B\bar{D}$
 Essential = $C, A\bar{D}$
 $F = C + A\bar{D} + (\bar{B}\bar{D} \text{ or } \bar{A}B)$

2-28.

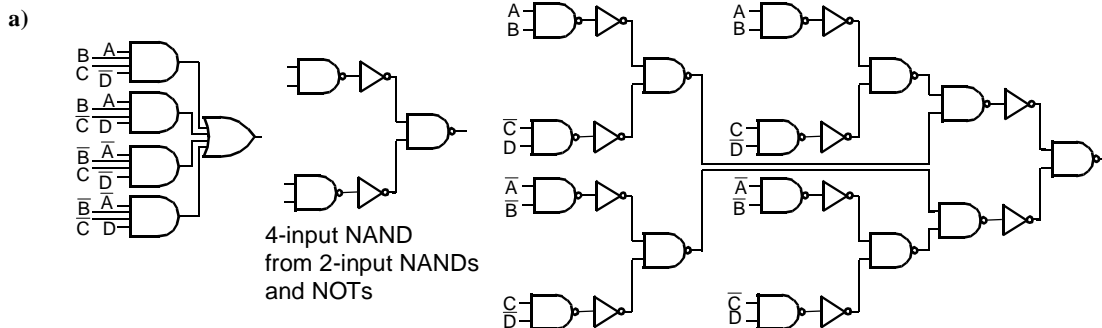

Problem Solutions – Chapter 2

b)

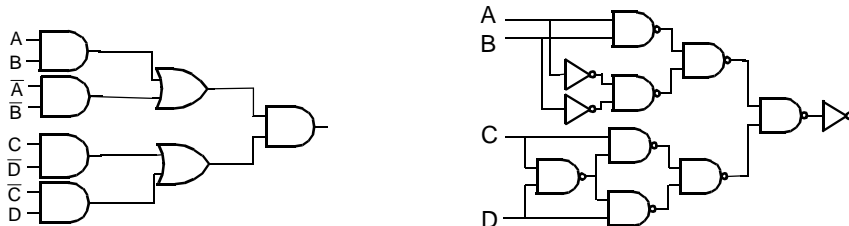

2-30.

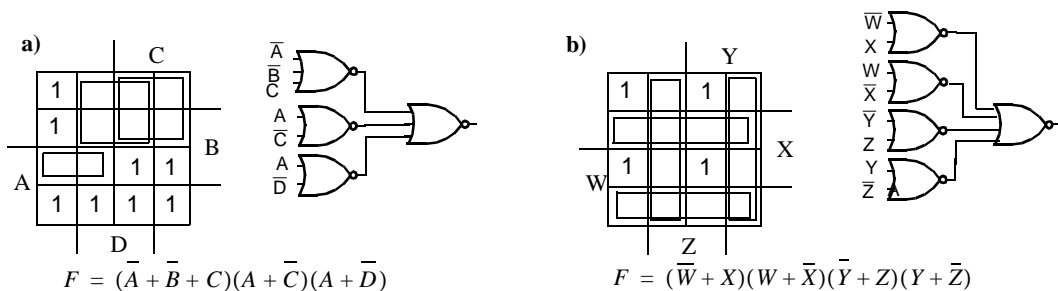

2-34.

$$\begin{aligned}
 X \oplus Y &= X\bar{Y} + \bar{X}Y \\
 \text{Dual}(X \oplus Y) &= \text{Dual}(X\bar{Y} + \bar{X}Y) \\
 &= (X + \bar{Y})(\bar{X} + Y) \\
 \overline{X\bar{Y} + \bar{X}Y} &= (\bar{X} + Y)(X + \bar{Y}) \\
 &= (X + \bar{Y})(\bar{X} + Y)
 \end{aligned}$$

2-37.

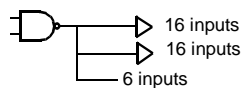

2-39.

$$4 \times 0.5 = 2 \text{ ns}$$

2-44.

X	Y	P-Logic		N-Logic	
		NAND	NOR	NAND	NOR
L	L	H	H	0	0
L	H	H	L	1	0
H	L	H	L	0	1
H	H	L	L	0	1