

# **King Fahd University of Petroleum & Minerals Computer Engineering Dept**

---

**COE 543 – Mobile and Wireless  
Networks**

**Term 072**

**Dr. Ashraf S. Hasan Mahmoud**

**Rm 22-148-3**

**Ext. 1724**

**Email: [ashraf@kfupm.edu.sa](mailto:ashraf@kfupm.edu.sa)**

3/25/2008

Dr. Ashraf S. Hasan Mahmoud

1

## **Lecture Contents**

---

1.

3/25/2008

Dr. Ashraf S. Hasan Mahmoud

2

## **Fixed Assignment Access for Voice-Oriented Networks**

---

- Voice-Oriented networks ~ cellular telephony or PCS
- Fixed allocation of resource (frequency, time, code, etc)
- Three basic access techniques:
  - Frequency Division Multiple Access (FDMA)
  - Time Division Multiple Access (TDMA)
  - Code Division Multiple Access (CDMA)
- The choice of technology impacts:
  - Capacity
  - QoS

3/25/2008

Dr. Ashraf S. Hasan Mahmoud

3

## **Background and References**

---

- Background:
  - Chapter 8, W. Stallings, "Data and Computer Communications," Sixth Edition, Prentice Hall International Inc.
- References:
  - Chapter 4 [Pahlavan]
  - Chapter 3 [Garg]

3/25/2008

Dr. Ashraf S. Hasan Mahmoud

4

## **Uplink/Down Link Duplexing**

---

- Mechanism to differentiate between uplink and downlink transmissions
- Two basic techniques are used:
  - Frequency Division Duplexing (FDD)
  - Time Division Duplexing (TDD)
- FDD
  - Usually large coverage areas
- TDD
  - Share one RF circuitry
  - Accurate open-loop power control (refer to IS-95)
  - Usually low-power local communications
- More will be provided later on the pros and cons of each of these technologies

3/25/2008

Dr. Ashraf S. Hasan Mahmoud

5

## **FDMA**

---

- All users may transmit simultaneously – each using a distinct carrier → channel
- Basics: Frequency Division Multiplexing (FDM)
- Design Issues:
  - Adjacent channel interference (refer to backup slides – voiceband signals)
  - RF spectrum mask
  - Near-far problem – a concern especially on reverse link
    - Carriers belonging to one set are not adjacent
    - Guard bands – reduces spectral efficiency

3/25/2008

Dr. Ashraf S. Hasan Mahmoud

6

## FDMA – cont'd

- A user is assigned a carrier  $f_i$  for each direction (uplink and downlink)
- A user may employ continuous transmission
- Data (user's info) is modulated using the assigned carrier
- Analog circuitry (VCO) is required to keep track of frequency shifts

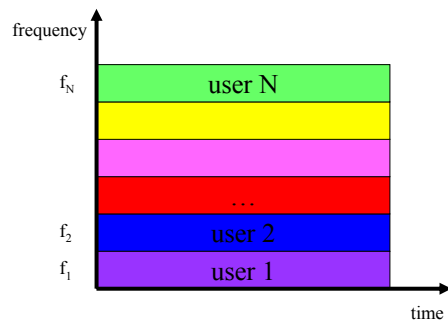

3/25/2008

Dr. Ashraf S. Hasan Mahmoud

7

## Example: AMPS

- A user is assigned an uplink and a downlink channels that are 45 MHz apart

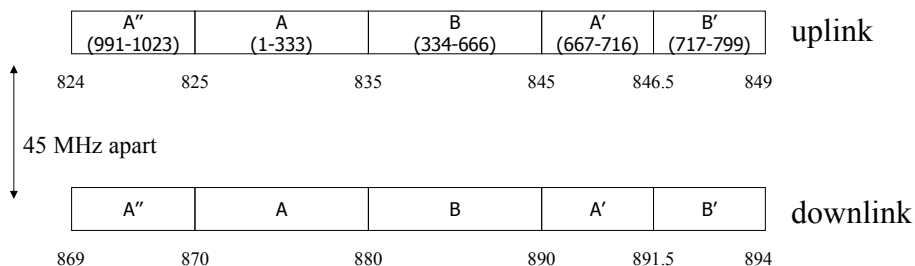

Original FCC designation:  
 A band for independent carriers  
 B for traditional wireline (regional Bell Operating Companies) carriers  
 A', B', and A'' were added later

3/25/2008

Dr. Ashraf S. Hasan Mahmoud

8

# Signal Mask – GSM Example

- GSM
  - Carrier spacing = 200 kHz

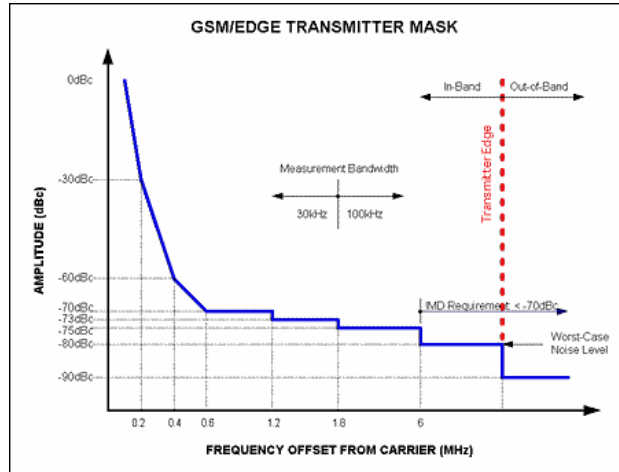

3/25/2008

From: [http://www.maxim-ic.com/appnotes.cfm/appnote\\_number/1886/ln/en](http://www.maxim-ic.com/appnotes.cfm/appnote_number/1886/ln/en)

# Near-Far Problem

MS<sub>i</sub> at distance 10 meters from BS  
 MS<sub>j</sub> at distance 1 km from BS  
 Assume two mobiles transmit same power

Since received power strength falls 40 dB/decade  
 → received power from MS<sub>i</sub> is 80 dB higher than that from MS<sub>j</sub>

Due multipath – RSS may fluctuate 10s of dB → difference in received power at BS may be > 100 dB

- An extreme case is shown in the figure on the side:
- For j: If out-of-band transmission of (i) is say 40 dB below transmitted power, it may swamp jth signal by 60 dB!!

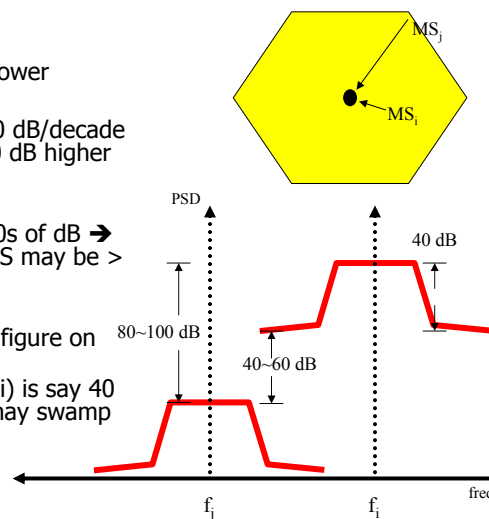

3/25/2008

Dr. Ashraf S. Hasan Mahmoud

10

## Time-Division Multiple Access

- A number of users share the same frequency band by taking assigned turns in using the channel
- BS controller assigns slots - slot released upon the completion of call
- Advantages:
  - Flexibility – can provide different access rates at no cost
- Disadvantages:
  - Requires accurate synchronization with BS and rest of users

3/25/2008

• Guard times Ashraf S. Hasan Mahmoud

11

## TDMA

- All the band is used by the user during his slot
  - Fixed assignment – predetermined order
  - Slot waster if there is no info for transmission

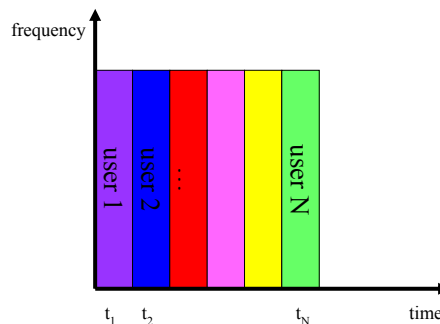

3/25/2008

Dr. Ashraf S. Hasan Mahmoud

12

## Example: GSM

- The user is assigned one uplink slot and one downlink slot

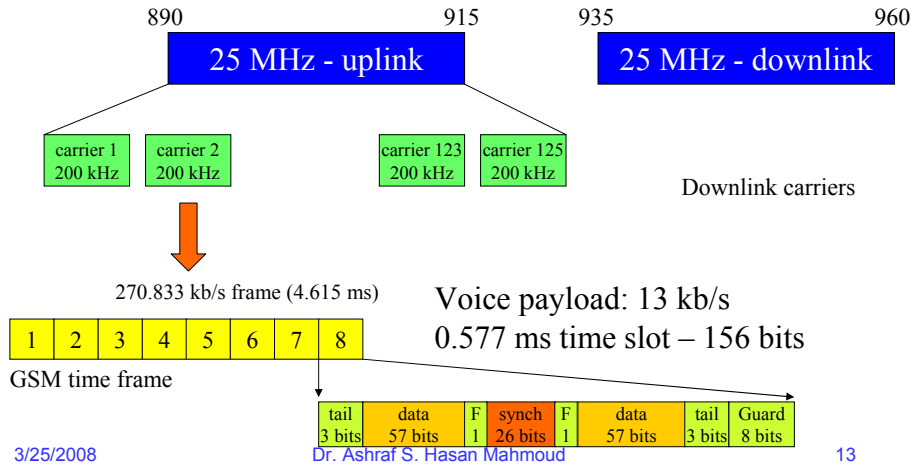

## Example: GSM – Speech coding

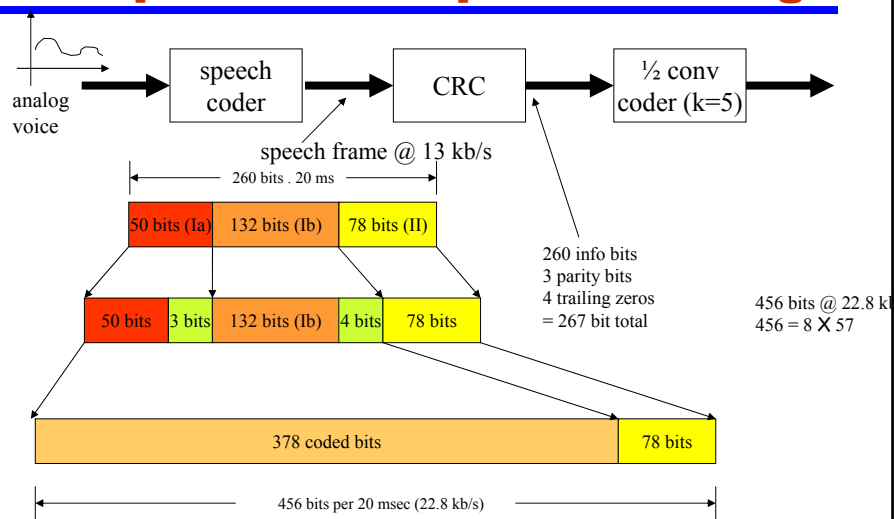

## Example: GSM – Speech coding

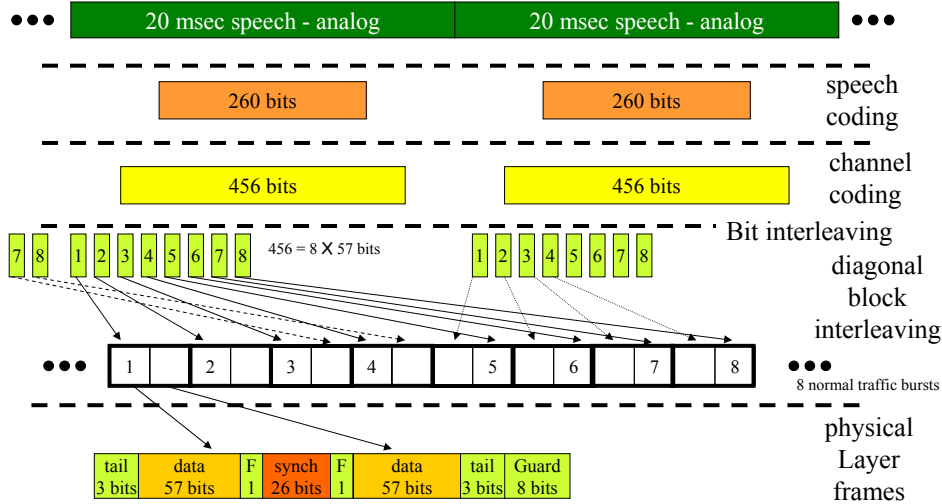

3/25/2008

Dr. Ashraf S. Hasan Mahmoud

15

## Example: GSM - References

- M. Rehnema, "Overview of the GSM System and Protocol," IEEE Communication Magazine, April 1993, pp. 92-100.
- J. Cia and David J. Goodman, "General Packet Radio Service in GSM," IEEE Communication Magazine, October 1997, pp. 122-131
- [http://www.it.iitb.ac.in/~it644/lectures/gsm\\_files/frame.htm](http://www.it.iitb.ac.in/~it644/lectures/gsm_files/frame.htm)

3/25/2008

Dr. Ashraf S. Hasan Mahmoud

16



## Capacity of FDMA and TDMA

- Review Cellular concepts slides

$$\text{No of channels per cell} = \frac{\text{Total BW} / \text{BW per user}}{\text{frequency reuse factor}}$$

But we already know that frequency reuse factor, K, and SIR are related by

$$\text{SIR} = S q^{\alpha/6} = (S/6) (3K)^{\alpha/2}, \text{ or}$$

$$K = 1/3 \times [6/S \times \text{SIR}]^{2/\alpha}$$

where S is the number of sectors at the BS

3/25/2008

Dr. Ashraf S. Hasan Mahmoud

17

## Capacity of FDMA and TDMA - Example

- Consider an FDMA or TDMA with the following parameters:

Total BW = 1.25 MHz,

Path-loss exponent,  $\alpha = 4$ ,

$\text{SIR}_{\min} = 18 \text{ dB (or } 63)$ ,

No of antenna sectors,  $S = 3$

BW per user = 10 kHz (~IS-54)

$$K = 1/3 \times [6/S \times \text{SIR}]^{2/\alpha} \approx 4$$

Therefore,

$$\begin{aligned} \text{No of channels (users) per cell} &= \frac{(1.25 \times 10^6) / (10 \times 10^3)}{4} \\ &= 31 \end{aligned}$$

3/25/2008

Dr. Ashraf S. Hasan Mahmoud

18

## Direct-Spread Code-Division Multiple Access (DS-SS)

- Spread Spectrum (SS): a technique in which a signal is of original bandwidth  $W$  is transmitted over a bandwidth equal to  $G \times W$  where  $G \gg 1$ 
  - $G$  is referred to as the spreading gain
- DS-SS: A bit stream of rate  $R$  b/s (bit duration,  $T_b = 1/R$  sec) occupies a bandwidth of  $W \approx R$  Hz
  - The bandwidth is roughly inversely proportional to the duration of the smallest signal element (bit), i.e.  $W \approx 1/T_b = R$
  - If the signal is multiplied by a code: where every bit is multiplied by a sequence of  $G$  chips each of duration  $T_c$ , then the new signal have a bandwidth  $\approx 1/T_c = G/T_b = G \times W$

Frequency hopping (FH) is another form of spread-spectrum technology – review chapter 3 [Pahlavan]

3/25/2008

Dr. Ashraf S. Hasan Mahmoud

19

## Code-Division Multiple Access (CDMA)

- DS-SS Transmitter (simplified)

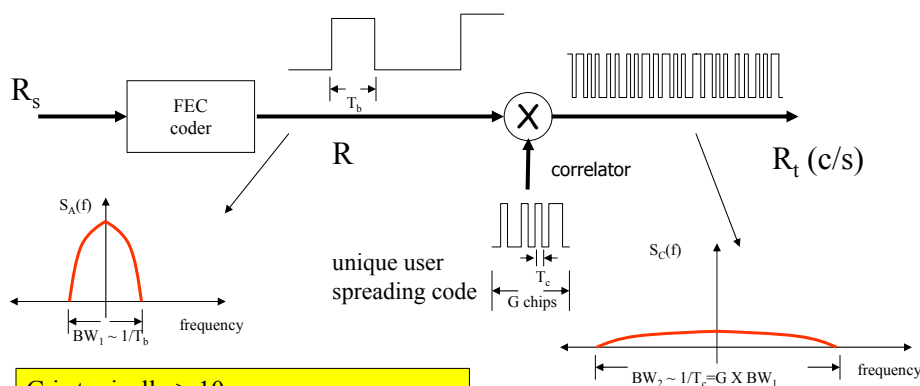

$G$  is typically  $> 10$   
 - For IS-95  $G = 9.6 \text{ kbs} / 1.25 \text{ MHz} = 128$

3/25/2008

Dr. Ashraf S. Hasan Mahmoud

20

## Code-Division Multiple Access (CDMA)

- DS-SS-CDMA Receiver (simplified):
  - Typically, the signal is passed through a LPF and then sampled - the samples are then used by the FEC decoder
  - An alternative receiver structure: Replace the correlator by a filter matched to the specific user code

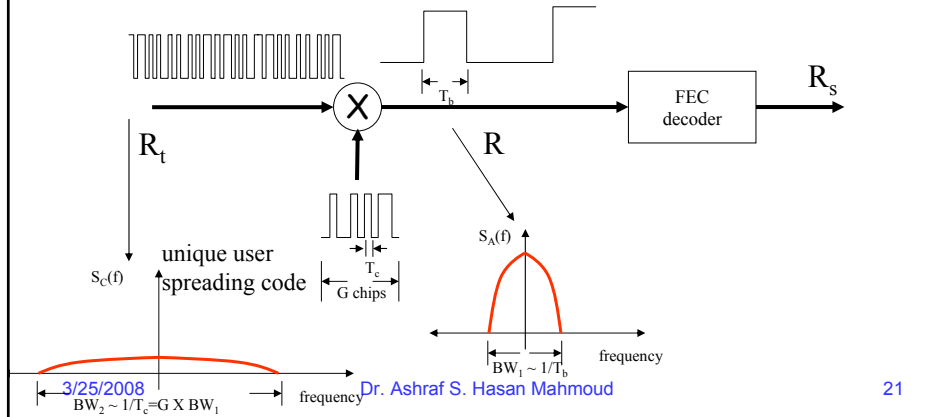

## How Does CDMA work?

- Input:
  - Assume we have N users transmitting simultaneously
  - Let the bit stream of the  $i^{\text{th}}$  user by  $R_i(t)$
  - Let the code assigned to the  $i^{\text{th}}$  user by  $C_i(t)$
  - Codes are ORTHOGONAL, i.e.
 
$$C_i(t) \times C_j(t) = 1 \text{ if } i = j$$

$$= 0 \text{ if } i \neq j$$
- Operation:
  - Each user uses its code to spread its signal – the signal transmitted by the  $i^{\text{th}}$  user is  $S_i(t) = R_i(t)C_i(t)$
  - The signal received (say by the base station) is the sum of all transmitted signals (ignore multi-path copies for the time being),

$$S_r(t) = \sum S_i(t) = \sum R_i(t)C_i(t)$$

## How Does CDMA work? – cont'd

- Demodulation (De-spreading):
  - Receiver dedicates a path structure per user – multiplies the received signal with the  $k^{\text{th}}$  user code

$$\begin{aligned} C_k(t) \times S_r(t) &= C_k(t) \times \sum S_i(t) \\ &= C_k(t) \times \sum R_i(t) C_i(t) \\ &= R_k(t) \end{aligned}$$

i.e. only the  $k^{\text{th}}$  signal is retrieved from the  $k^{\text{th}}$  receiver path

Simplified basestation receiver

Codes are only orthogonal if  
-Perfect synchronization is achieved  
-No multipath exists

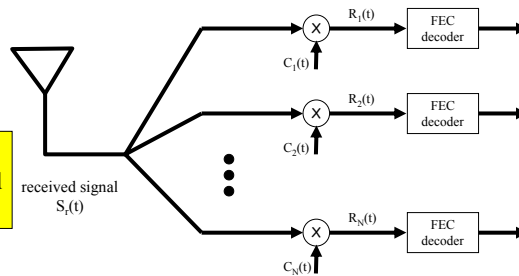

3/25/2008

Dr. Ashraf S. Hasan Mahmoud

23

## Code Division Multiple Access

- User transmits all the time (not in a particular slot) and using all the frequency bandwidth
- User is assigned a distinct code
- A frequency reuse factor of one is potentially possible with CDMA

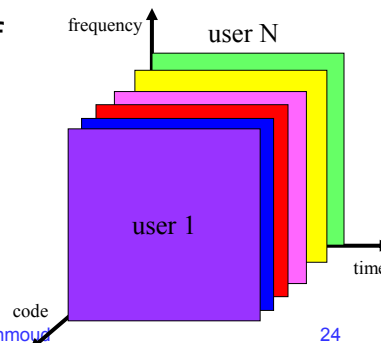

3/25/2008

Dr. Ashraf S. Hasan Mahmoud

24

## Signal Quality for DS-CDMA

- Let there be  $N$  users in the cell
- The SIR at the receiver before the correlator is roughly equal to  $1/(N-1)$  – **assuming each is transmitting  $P_i$  Watts such that  $P_i \times \text{Channel Attenuation}_i$  is equal for all users**
- The SIR at the receiver after the correlator or matched filter is roughly equal to  $G/(N-1)$

- The de-spreading procedure involves:
  1. Concentrating of the desired power in the bandwidth of interest
  2. Diluting the power of the interferers – this is referred to as **interference suppression**
- SIR after correlator =  $G/(N-1)$
- Because of this property CDMA-based networks can tolerate more (~10-20%  $G$ ) interference compared to FDMA or TDMA based networks

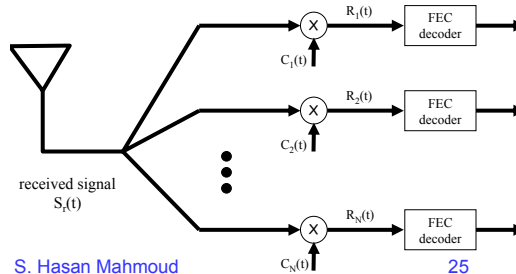

### CDMA Example – transmission from two sources

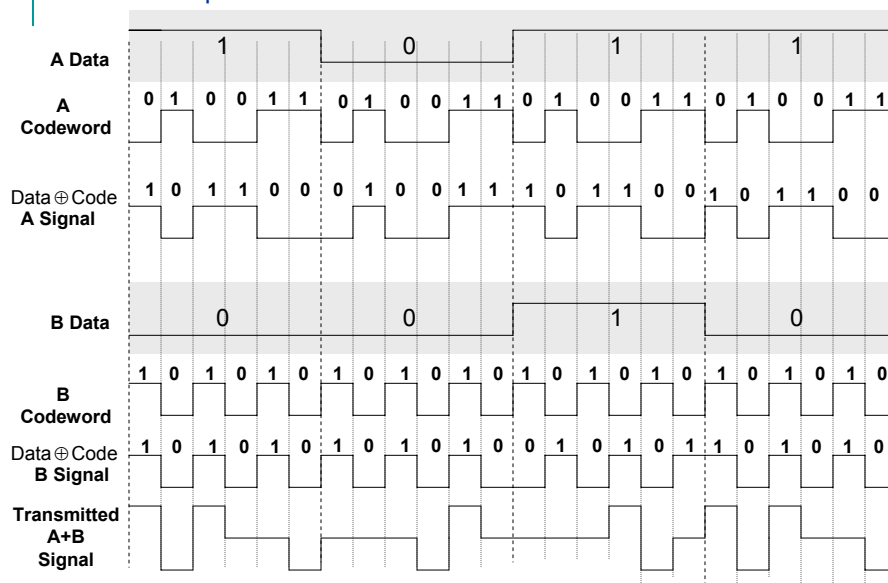

### CDMA Example – recovering signal A at the receiver

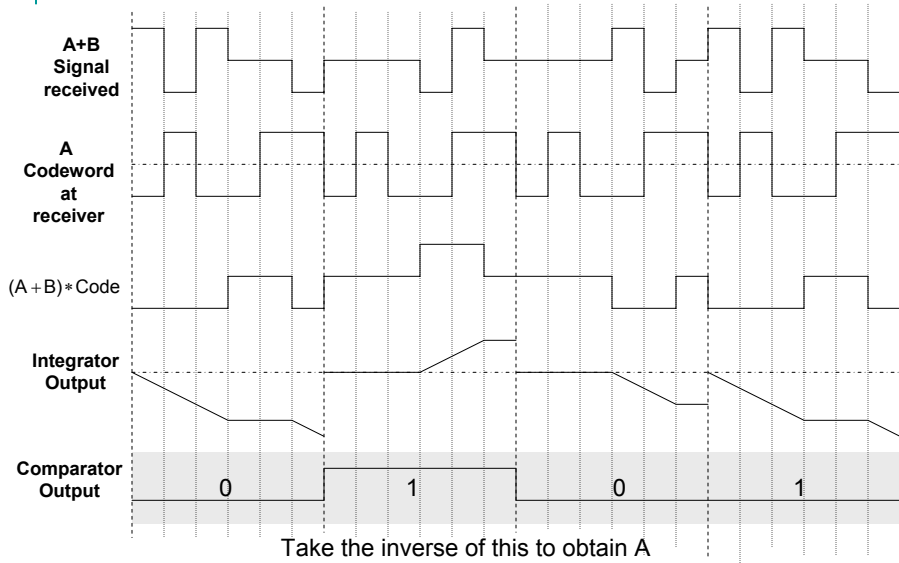

CS 515

Ibrahim Korpeoglu

27

### CDMA Example – recovering signal B at the receiver

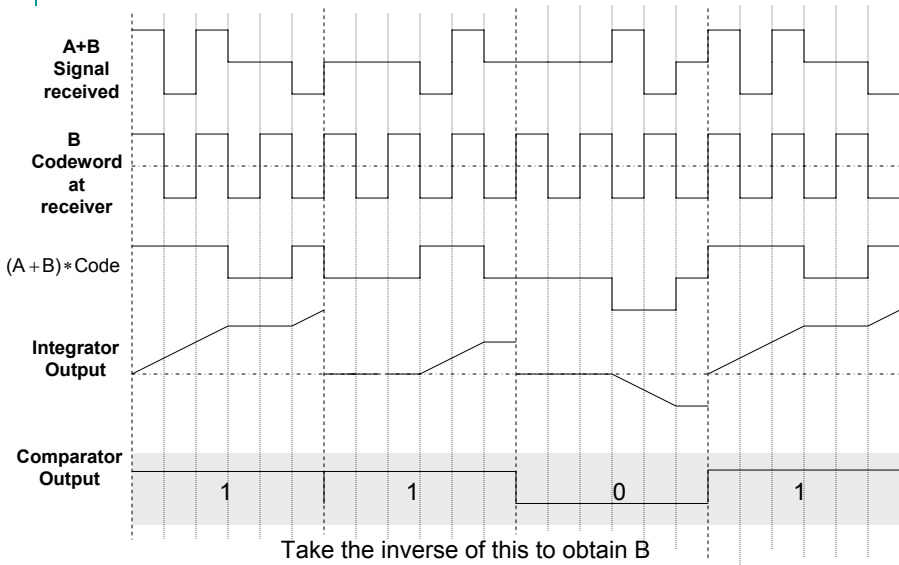

CS 515

Ibrahim Korpeoglu

28

### CDMA Example – using wrong codeword at the receiver

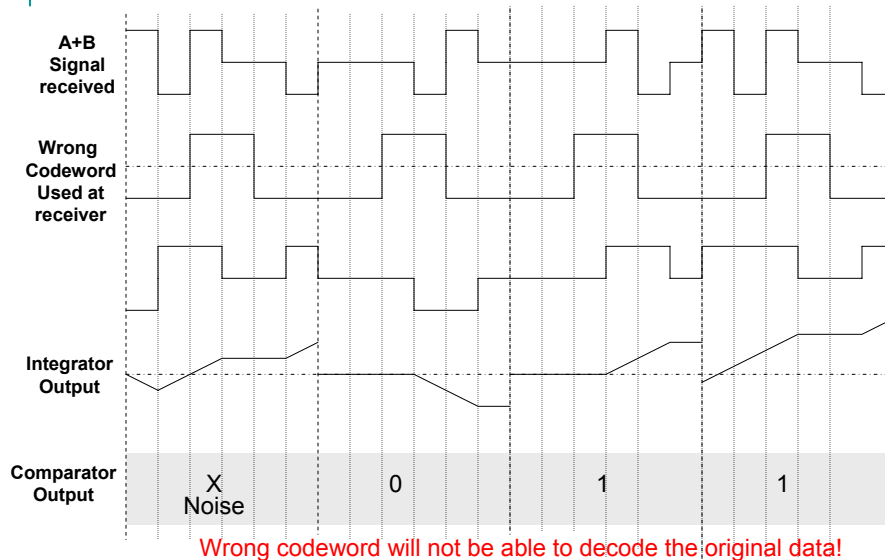

CS 515

Ibrahim Korpeoglu

29

## Signal Quality for DS-CDMA – cont'd

- The analysis and conclusions in previous slide are true only if the underlined assumption is true
  - Therefore CDMA system require a mechanism to ensure that the received signal power from different users at the receiver is not more than what is required for proper modulation and decoding of the signal
  - Near-far problem again!
  - This mechanism is called **power-control**
- CDMA requires an excellent power control mechanism to utilize its interference suppression advantage

3/25/2008

Dr. Ashraf S. Hasan Mahmoud

30

## Uplink Interference Calculation

- Consider the link quality of one mobile of interest
- Interference received by the BS at the cell of interest,  $I_{total}$

$$I_{total} = I_{intra} + I_{inter}$$

where  $I_{intra}$ : interference power from users within the cell of interest (remember all users are transmitting all the time on the same band),

$I_{inter}$ : interference power from user outside the cell of interest

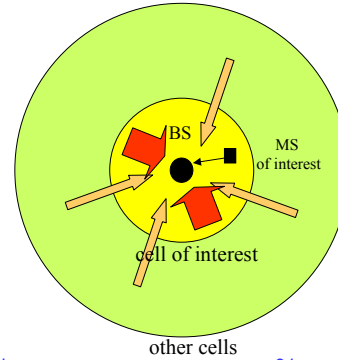

3/25/2008

Dr. Ashraf S. Hasan Mahmoud

31

## Uplink Interference Calculation – cont'd

Typically,  $I_{inter}$  is a fraction of  $I_{intra}$ , therefore  $I_{total}$  can be written as

$$I_{total} = I_{intra} (1 + I_{inter}/I_{intra}), \text{ or}$$

$$I_{total} = I_{intra} \times F$$

Typical values for F range from 1.2 to 1.6 or higher depending on the propagation model, power control, etc.

$I_{intra}$  is assumed to be  $(N-1) \times P$  where N is the number of users in the cell of interest and P is the received power from each user at BS (note the perfect power control assumption)

Hence,

$$I_{total} = F \times (N-1) \times P$$

If the BS is employing sectorized antennas, then the amount of received interference is inversely proportional to the number of sectors, S; This translates to

$$I_{total} = F \times (N-1) \times P / S$$

Furthermore, if interfering calls are only active  $v$  fraction of the time, then the actual total received interference is given by

$$I_{total} = v \times F \times (N-1) \times P / S$$

For voice users,  $v \sim 0.4$

3/25/2008

Dr. Ashraf S. Hasan Mahmoud

32



## Signal Quality for DS-CDMA – cont'd

- Consider a cellular CDMA network – N users per cell
- Received SIR for i<sup>th</sup> user is given by (note  $P_i = P \times \text{Channel\_Attenuation}$ )

$$\text{SIR}_i = \frac{P_i}{\text{Total interference}} = \frac{1}{v \times F \times X \times (N - 1)/S}$$

where

N = total number of user per cell

F = ratio of  $(P_{\text{int}} / \sum P_i) + 1$  – typically 1.2~1.6

v = activity factor on the interfering links – about 40% for voice

S = number of antenna sectors at the BS

Writing this in terms of  $(E_b/N_o)_i$ ,

$$(E_b/N_o)_i = \frac{\text{System BW}}{R_i} \times \frac{S}{v \times F \times X \times (N - 1)} = G \times \frac{S}{v \times F \times X \times (N - 1)}$$

Or

$$N = 1 + S \times \frac{G}{v \times X \times (E_b/N_o) \times F}$$

N is the maximum number of user per cell, if  $E_b/N_o$  is the minimum required quality for properly received signal

3/25/2008

Dr. Ashraf S. Hasan Mahmoud

33

## Example: IS-95 Capacity

- Parameters for IS-95:

System BW = 1.25 MHz

User bit rate = 9.6 kb/s

→ Spreading gain,  $G = (1.25 \times 10^6) / (9.6 \times 10^3) = 128$

S = number of sectors = 3

V = voice activity factor = 0.4

$(E_b/N_o)_{\text{min}}$  = minimum required signal to interference-plus-noise ratio per bit = 7 dB or  $10^{7/10} = 5.01$

F = ratio of total interference to inter-cell interference = 1.6

Therefore number of users per cell, N,

$$N = 1 + S \times G / (v \times F \times X \times (E_b/N_o)_{\text{min}}) = 120$$

Compare this to about 31 user for an equivalent FDMA or TDMA as in previous example →  $120/31 \approx 4$  times

3/25/2008

Dr. Ashraf S. Hasan Mahmoud

34

## Example – Problem 4.6

A GSM system with sectored antennas ( $K = 5$ ) is to replace AMPS ( $K = 7$ ) with same cell sites.

- Determine the no of voice channels per cell for the AMPS
- Determine the no of voice channels per cell site for the GSM
- Repeat (b) if a W-CDMA system with  $BW = 12.5$  MHz for each direction is to be used. Assume a signal-to-noise requirement of 4 (or 6 dB) and include effects of antenna sectorization ( $2.75$ )<sup>(1)</sup>, voice activity, and intercell interference ( $F = 1.6$ )

(1) – The effective sectorization is 2.75 considering antenna imperfections – Although  $S$  may be equal to 4 or even 6 but interference is reduced to  $1/2.75$  rather than  $1/4$  or  $1/6$

3/25/2008

Dr. Ashraf S. Hasan Mahmoud

35

## Example – Problem 4.6

Solution:

- For AMPS (ignoring control channels):

$$N = 12.5 \text{ MHz} / (7 \times 30 \text{ kHz}) = 59 \text{ channels}$$

- For GSM

$$N = 12.5 \text{ MHz} \times 8 \text{ slots} / (4 \times 200 \text{ kHz}) = 125 \text{ channels}$$

- For W-CDMA

$$N = 1 + (12.5 \text{ MHz} / 9.6 \text{ kb/s}) \times 2.6 / (0.4 \times 1.6 \times 4) = 1323 \text{ users!!}$$

3/25/2008

Dr. Ashraf S. Hasan Mahmoud

36

## Qualcomm IS-95 Systems

- Operates in the same frequency band as AMPS
- Uses FDD with 25 MHz for each direction
- User Identification:
  - Forward link: 64 Walsh codes (orthogonal codes) are used
  - Reverse link: long PN code with different time shifts
- Different modulation techniques on downlink and uplink
  - O-QPSK
  - QPSK
- Downlink pilot signals are transmitted to assist mobiles acquire and track the correct frequency and phase
- Strong coding is used (especially on reverse link)
- Required Eb/No for correct operation 5~7 dB
- Power control is essential

3/25/2008

Dr. Ashraf S. Hasan Mahmoud

37

## Qualcomm IS-95 Systems

### Parameters for IS-95B System

Modulation	QPSK/O-QPSK
Chip rate	1.288 Mc/s
Channel rate	1.2, 2.4, 4.8, 9.6 kb/s (RS-1) 1.8, 3.6, 7.2, 14.4 kb/s (RS-2)
Filtered BW	1.25 MHz
Coding	1/2 (1/3) convolutional code for downlink (uplink) Viterbi decoding for both
Interleaving	With 20 ms spans
Power control	Open-loop, closed-loop (800 b/s) control
Vocoder	Variable rate ~ 1- 8 kb/s
Receiver	RAKE – take advantage of multipath

3/25/2008

Dr. Ashraf S. Hasan Mahmoud

38

## Qualcomm IS-95 Systems

### Forward traffic channel structure (Rate Set 1)

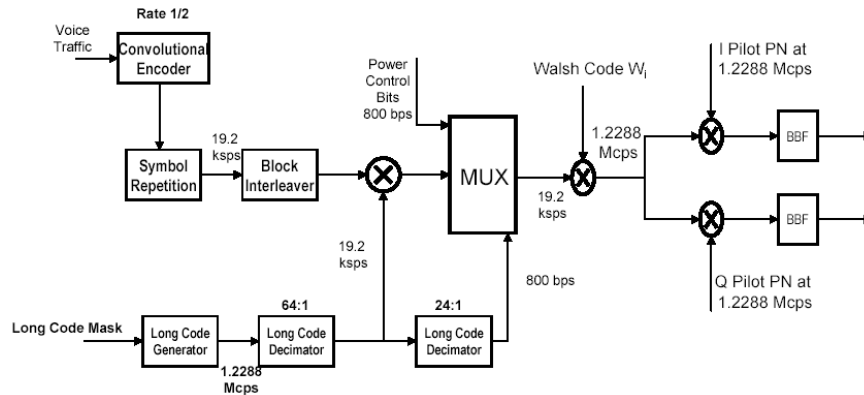

3/25/2008

Dr. Ashraf S. Hasan Mahmoud

39

## Qualcomm IS-95 Systems – cont'd

- Power Control Functionality:
  - Open loop:
    - upon powering up, MS measures received power from BS and adjusts its transmit power → not optimal – why?
    - The pilot signal is used as a reference
  - Closed loop:
    - A feedback mechanism is implemented between the BS and the MS to control the transmit level at the MS
    - IS-95 uses 800 commands per second to perform this function
- Softhandoff:
  - MS communicates with more than one BS
  - Downlink: Signals arriving from multiple BS (carrying same info) are received by the RAKE receiver and combined as one signal
  - Uplink: MS's signal received by more than one BS – combined by the network (BSC or MSC)

3/25/2008

Dr. Ashraf S. Hasan Mahmoud

40

## Qualcomm IS-95 System – cont'd

- Original receiver design – tap delays were fixed – nowadays tap delays are variable (tracking functionality)
- Delays short enough to resolve distinct paths (usually one or half chip duration)
- Goal: to capture all major paths
- Multiple signal paths are combined:
  - Selectively,
  - Equal-gain, or
  - Maximal ratio → the optimal method
- IS-95 calls for a 3 moving fingers

### General Rake Receiver Structure

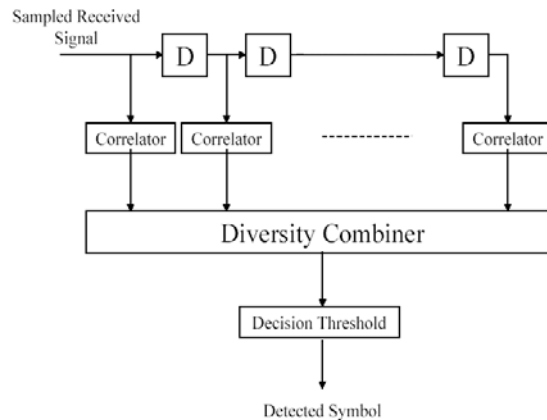

3/25/2008

Dr. Ashraf S. Hasan Mahmoud

41

## Space Division Multiple Access

- Control the radiated energy for each user
- Users are served using "spot beam" antennas
- Spot beams may use same frequency (as in TDMA or CDMA) or different frequencies (as in FDMA)
- Sectorized antenna – is one primitive form of SDMA – review capacity expansion technique slides
- Adaptive antenna array:
  - Steer multiple beams (one for each user)
  - Best suited for TDMA or CDMA systems
- Difficult for reverse link:
  - Requires coordination of power levels
  - Huge power required to form beams - not available

3/25/2008

Dr. Ashraf S. Hasan Mahmoud

42

## Space Division Multiple Access – cont'd

---

- More practical, at least to date, at the BS
- The limiting case:
  - Infinitesimal beam width and infinitely fast tracking ability → zero interference
  - All users communicate to BS on one channel
  - Able to combine multipath signals for one user and obtain a better signal
  - Not feasible since it requires infinite number of elements
- Gains can be achieved using reasonably sized antenna beams

3/25/2008

Dr. Ashraf S. Hasan Mahmoud

43

## Comparison Between FDMA, TDMA and CDMA

---

- Read section 4.2.4 in book - Important

3/25/2008

Dr. Ashraf S. Hasan Mahmoud

44

## Performance of Fixed-Assignment Access Methods

- FDMA/TDMA provide a hard capacity limit (number of channels)
  - FDMA – maximum number of carriers per cell
  - TDMA – maximum number of slots per frame X number of carriers per cell
- CDMA-based also has a hard capacity limit dictated by the number of Walsh codes for example, but usually practical capacity is lower
  - Soft-capacity figure: Near the capacity boundary, the addition of one extra user degrades the link quality for all
  - Call admission control mechanism attempt to limit maximum number of ongoing calls before link quality degrades for all
- If you operate a maximum no of channels, then call blocking and call delay are the two important measures!

3/25/2008

Dr. Ashraf S. Hasan Mahmoud

45

This material has been presented in the Cell Concept Module

## Erlang-B and Erlang-C Models

- More details to be provided in COE540
- Model designed to predict blocking probability (Erlang-B) and average call delay (Erlang-C) for a given number of channels and traffic intensity
- Valid for voice and traffic models conforming to the basic assumption (usually not applicable to data)
- Assumptions, Terminology and Parameters:
  - Channels  $\leftrightarrow$  Servers:  $c$  servers
  - Users  $\leftrightarrow$  Calls
  - Calls arrive according to a Poisson process with rate =  $\lambda$ 
    - Inter-call arrival is an exponentially distributed r.v. with mean  $1/\lambda$
  - Call duration is exponentially distributed r.v. with mean =  $1/\mu$
  - Traffic intensity,  $\rho = \lambda/\mu$

3/25/2008

Dr. Ashraf S. Hasan Mahmoud

46

## Erlang-B (M/M/c/c) Model – Call Blocking

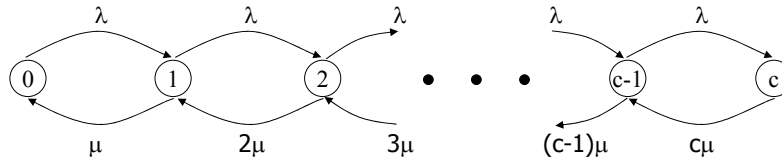

- As was shown earlier – review previous notes, the call blocking probability is given by

$$B(c, \rho) = \frac{\rho^c / c!}{\sum_{i=0}^c \rho^i / i!}$$

- $\rho$  – is referred to as the offered load, while  $\rho X[1-B(c, \rho)]$  is referred to as the carried load
- Note in this model – calls arriving while there are c calls are blocked – no buffering is employed

3/25/2008

Dr. Ashraf S. Hasan Mahmoud

47

## Erlang-C (M/M/c) Model – Call Delay

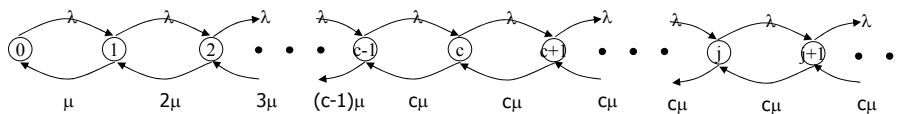

- The probability that an arriving call having to wait is given by

$$\Pr(\text{delay} > 0) = \frac{\rho^c}{\rho^c + c! \left(1 - \frac{\rho}{c}\right) \sum_{k=0}^{c-1} \frac{\rho^k}{k!}}$$

- The average delay is given by

$$D = \Pr(\text{delay} > 0) \times \frac{1}{\mu(c - \rho)}$$

- The probability of the delay exceeding t time units is given by

$$\Pr(\text{delay} > t) = \Pr(\text{delay} > 0) e^{-(N-\rho)\mu t}$$

3/25/2008

Dr. Ashraf S. Hasan Mahmoud

48



## Examples

- An IS-136 cellular provider owns 50 cell sites and 19 traffic carriers per carrier per cell each with bandwidth of 30 kHz. Assuming each user makes three calls per hour and the average holding time per call is 5 minutes. Determine the total number of subscribers that the service provider can support with a blocking rate less than 2%

- Solution:

$$c = 19 \times 3 = 57 \text{ per cell}$$

$$B(57, \rho) = 0.02 \rightarrow \rho = 45 \text{ Erlangs per cell}$$

$$(\lambda/\mu)_{\text{sub}} = 3/60 \times 5 = 0.25 \text{ Erlangs per sub}$$

$$\text{Number of subs} = \text{total traffic} / \text{traffic per user}$$

$$= 45 / 0.25$$

$$= 180 \text{ per cell}$$

$$\text{Number of subs for all sites} = 180 \times 50 = 9,000 \text{ subs}$$

Note that  $\rho_{\text{all\_subs}} = (\lambda/\mu)_{\text{all\_subs}}$   
 $= \lambda_{\text{all\_subs}}/\mu$   
whereas,  $\rho_{\text{sub}} = (\lambda/\mu)_{\text{sub}}$   
 $= \lambda_{\text{sub}}/\mu$   
 $\lambda_{\text{all\_subs}} = \text{no of subs} \times \lambda_{\text{sub}}$

## CDMA Capacity Revisited - Downlink

- Reverse link capacity was analyzed before – Refer to the “Uplink Interference Calculation” Slides.
  - Assume perfect power control – i.e. all signals received at basestation arrive with the required  $E_b/N_0$  always (not more and not less)
- What about downlink calculations?
- The amount of users/transmissions/channels to be supported on the uplink or downlink is variable – Erlang models can not be applied directly!!

## CDMA Capacity Revisited – Downlink – con'td

- Consider a basestation in the cell of interest, cell 0, serving  $N$  users
- $i^{\text{th}}$  ( $i=0, 2, \dots, N-1$ ) user is at distance  $d_i$  from basestation → The corresponding pathloss attenuation between the user and our cell is equal to  $PL_{i0}$  (computed using the appropriate model – refer to the RF propagation module)
- The  $i^{\text{th}}$  user is assigned a data rate  $R_i$  – Assume the system bandwidth =  $W$  Hz
- The downlink transmissions from one basestation are ideally orthogonal – however, in practice, there is loss of orthogonality and therefore, simultaneous downlink transmissions interfere with one another – assume orthogonality factor,  $\rho$ , where  $0 < \rho < 1$  (i.e.  $\rho = 1$  means perfect orthogonality -  $\rho = 0$  means total loss of orthogonality)

3/25/2008

Dr. Ashraf S. Hasan Mahmoud

51

## CDMA Capacity Revisited – Downlink – 3

- The basestation can assign any of the follow bit rates  $=\{R_i, 2^i R_0, i=0, 1, \dots, 5\}$  where  $R_0 = 9.6$  kb/s - Assume users request the highest rate possible given the available power and interference conditions
- The basestation allocates enough transmit power,  $P_i$ , to the  $i^{\text{th}}$  mobile such that received  $(E_b/N_0)_i$  is at least equal to a required  $E_b/N_0$  threshold.
- The basestation is continuously transmitting overhead channels (pilot, sync and paging) – amount of power allocated to overhead channels is  $P_{ov}$  Watts
- The total power budget for basestation is equal to  $P_{total}$  Watts – The amount of power that can be used for traffic channels is given by  $(1 - \beta)P_{total}$  – where  $P_{ov} = \beta P_{total}$
- Assume interferers of 1<sup>st</sup> tier are equally loaded (i.e. if the total transmit power of our basestation is  $X$  Watts, then each of the cochannel interferes is transmitting  $X$  Watts)
  - Transmissions of one basestation are completely inorthogonal to transmissions of another basestation
- Thermal noise can be neglected

3/25/2008

Dr. Ashraf S. Hasan Mahmoud

52

## CDMA Capacity Revisited – Downlink – 4

- Let us write the received SIR formula at the mobile:
  - Our cell is transmitting:
 
$$\sum_{i=0}^{N-1} P_i + P_{ov}$$
  - Each of the other cochannel interferers is transmitting the same power

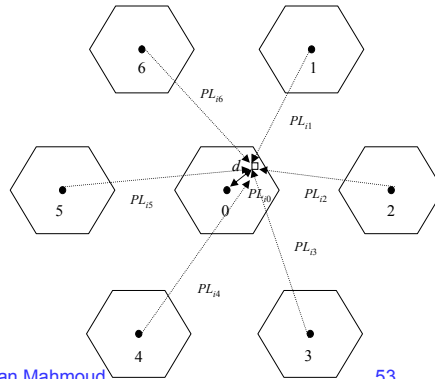

3/25/2008

Dr. Ashraf S. Hasan Mahmoud

53

## CDMA Capacity Revisited – Downlink – 5

- Let us write the received SIR formula at the mobile:

$$SIR_i = \frac{P_i P_{L_{i0}}}{(1-\rho) P_{L_{i0}} \left[ \sum_{j=0, j \neq i}^{N-1} P_j + P_{ov} \right] + \left[ \sum_{j=0}^{N-1} P_j + P_{ov} \right] \sum_{k=1}^6 P_{L_{k0}} + \text{ThermalNoise}}$$

Transmissions from our cell of interest  
 Transmissions from cochannel cells  
 Thermal noise power – usually ignored

But the relation between  $E_b/N_o$  and SIR is given by (review COE342 textbook chapter 3):

$$\left( \frac{E_b}{N_o} \right)_i = \frac{W}{R_i} \times SIR_i$$

3/25/2008

Dr. Ashraf S. Hasan Mahmoud

54

## CDMA Capacity Revisited – Downlink – 6

- Notes:
  - Thermal noise power is usually negligible compared with interference power
  - Transmissions from our cell of interest interfere as long as there is orthogonality loss (i.e.  $\rho < 1$ )
  - Transmissions from cochannel cells ALWAYS interfere regardless of the orthogonality factor  $\rho$

## CDMA Capacity Revisited – Downlink – 7

- Let us write the  $E_b/N_o$  for the  $i^{\text{th}}$  transmission:

$$\left(\frac{E_b}{N_o}\right)_i = \frac{W}{R_i} \times \frac{P_i PL_{i0}}{(1-\rho)PL_{i0} \left[ \sum_{j=0, j \neq i}^{N-1} P_j + P_{ov} \right] + \left[ \sum_{j=0}^{N-1} P_j + P_{ov} \right] \sum_{k=1}^6 PL_{k0}}$$

- Dividing the numerator and denominator by  $PL_{i0}$  results in

$$\left(\frac{E_b}{N_o}\right)_i = \frac{W}{R_i} \times \frac{P_i}{(1-\rho) \left[ \sum_{j=0, j \neq i}^{N-1} P_j + P_{ov} \right] + f_i \left[ \sum_{j=0}^{N-1} P_j + P_{ov} \right]}$$

where  $f_i$  is given by  $f_i = \left[ \sum_{k=1}^6 PL_{k0} \right] / PL_{i0}$

Note that  $f_i$  is only a function of the mobile location in the  $0^{\text{th}}$  cell (cell of interest).

## CDMA Capacity Revisited – Downlink – 8

- For every (x,y) location in the 0<sup>th</sup> cell (cell of interest), and given a Path Loss Model one can calculate:
  - The path loss coefficient between the user and the 0<sup>th</sup> cell,  $PL_0$
  - The path loss coefficient between the user and each of the 6 co-channel interferers  $PL_{k0}$  ( $k=1,2, \dots, 6$ ).
  - $f_i$  is obtained by dividing  $PL_0$  by the sum of  $PL_{k0}$ s
- If we assume a Hata RF propagation model – then  $f_i$  can be approximated by a 6<sup>th</sup> degree polynomial as shown in the following matlab code – d is the mobile distance from the center of 0<sup>th</sup> cell, i.e.  $d = \sqrt{x^2+y^2}$
- The Hata RF model is also shown

3/25/2008

Dr. Ashraf S. Hasan Mahmoud

57

## CDMA Capacity Revisited – Downlink – 9

```
function f = f_function( d );
P = [-11.9104 31.0419 -25.2090 9.8841 -1.4902 0.0739 -0.0004];
f = polyval(P, d);
if (length(f) > 1)
    I = find(f < 0);
    f(I) = 0;
else
    if (f < 0) f = 0;
end
end

function L50 = HataModel( d, fc, hb, hm);
%
%
ahm = 3.2*(log10(11.75*hm)).^2 - 4.97;
L50 = 69.55 + 26.16 * log10(fc) - 13.82 * log10(hb) - ...
    ahm + (44.9 - 6.55 * log10(hb))* log10(d);
```

Remember:  
The output of the RF model is in dBs  
Typical values for inputs:  
CellR = 1.0 % cell radius;  
fc = 2000; % carrier freq in MHz  
hb = 50.0; % basestation antenna height - meters  
hm = 3.0; % mobile antenna height - meters

3/25/2008

Dr. Ashraf S. Hasan Mahmoud

58

## CDMA Capacity Revisited – Downlink – 10

- Back to the Eb/No equations (i=0, 1, ..., N-1)

$$\left(\frac{E_b}{N_o}\right)_i = \frac{W}{R_i} \times \frac{P_i}{(1-\rho) \left[ \sum_{j=0, j \neq i}^{N-1} P_j + P_{ov} \right] + f_i \left[ \sum_{j=0}^{N-1} P_j + P_{ov} \right]}$$

- For a given set of N users with known locations, then the assigned Pi's (i=0, 1, ..., N-1) is governed by the set of linear equations above
- The conditions of the Pi's (the solution for the above linear system) are:
  - Pi > 0 for all i = 0, 1, ..., N-1
  - Sum of all Pi's should be less or equal that what a basestation can allocate for traffic ((1-β) Ptotal)
- Otherwise, the solution for Pi's is not acceptable

3/25/2008

Dr. Ashraf S. Hasan Mahmoud

59

## CDMA Capacity Revisited – Downlink – 11

- How does the linear system of equations look like?
- To answer this question let us rewrite the Eb/No equation as

$$E_i = G_i \times \frac{P_i}{(1-\rho + f_i) \left[ \sum_{j=0, j \neq i}^{N-1} P_j + P_{ov} \right] + f_i P_i}; \quad i = 0, 1, \dots, N-1$$

where  $E_i = (E_b/N_0)_i$ , and  $G_i = W/R_i$

- Or

$$(E_i f_i - G_i) P_i + E_i (1 - \rho + f_i) \left[ \sum_{j=0, j \neq i}^{N-1} P_j \right] = -E_i (1 - \rho + f_i) P_{ov} \quad i = 0, 1, \dots, N-1$$

3/25/2008

Dr. Ashraf S. Hasan Mahmoud

60

## CDMA Capacity Revisited – Downlink – 12

- Using the above notations, the linear system is given by

$$\begin{bmatrix} (E_b f_0 - G_0) & E_b(1-\rho+f_0) & \dots & E_b(1-\rho+f_0) & \dots & E_b(1-\rho+f_0) \\ E_b(1-\rho+f_1) & (E_b f_1 - G_1) & \dots & E_b(1-\rho+f_1) & \dots & E_b(1-\rho+f_1) \\ \vdots & \vdots & \ddots & \vdots & \ddots & \vdots \\ E_b(1-\rho+f_i) & E_b(1-\rho+f_i) & \dots & (E_b f_i - G_i) & \dots & E_b(1-\rho+f_i) \\ \vdots & \vdots & \ddots & \vdots & \ddots & \vdots \\ E_{b_{N-1}}(1-\rho+f_{N-1}) & E_{b_{N-1}}(1-\rho+f_{N-1}) & \dots & E_{b_{N-1}}(1-\rho+f_{N-1}) & \dots & (E_{b_{N-1}} f_{N-1} - G_{N-1}) \end{bmatrix} \times \begin{bmatrix} P_0 \\ P_1 \\ \vdots \\ P_i \\ \vdots \\ P_{N-1} \end{bmatrix} = -P_{ov} \begin{bmatrix} E_b(1-\rho+f_0) \\ E_b(1-\rho+f_1) \\ \vdots \\ E_b(1-\rho+f_i) \\ \vdots \\ E_{b_{N-1}}(1-\rho+f_{N-1}) \end{bmatrix}$$

using conventional methods (reduced row echelon form, LU decomposition, etc) to solve this system requires  $O(N^3)$  operations – However, one can exploit the system structure (coefficients in one row are equal except for the  $i$ th entry) to solve the system using Sherman-Morrison-Woodbury method (page 51 of Matrix Computation - Golub and van Loan, 2nd ed.) for  $O(N^2)$  operations.

3/25/2008

Dr. Ashraf S. Hasan Mahmoud

61

## CDMA Capacity Revisited – Downlink – 13

- Code:**  

```
function [Flag, Powers] = GetRequiredPower(BW, Rho, Ptotal, ...
    Pov, Rates, f_d, Nt, EbNo)
Flag = 0;
Powers = zeros(1,Nt);
G = BW./Rates;
% A * P = b
% build the A matrix
A = zeros(Nt, Nt);
A = -(EbNo./G).*(1-Rho+f_d)' * ones(1,Nt);
Ad = 1-(EbNo./G).*f_d;
for i=1:Nt;
    A(i,i) = Ad(i);
end
%
% for the b vector
b = (EbNo./G).*(1-Rho+f_d) .* Pov;
%
% Solve for the powers
P = A\b;
%
% Test validity of solution
if (~(sum(P<0))) & (sum(P) < (Ptotal - Pov))
    Flag = 1;
    Powers = P;
end
```

The following function in matlab solves the system of equations to determine if the current set of transmissions can be supported or not

### Mapping between code variables and variables used in the previous slides:

BW → W (bandwidth of System)  
 Rho → ρ (orthogonality loss factor)  
 Ptotal → Ptotal (total basestation power)  
 Pov → Pov (overhead power allocation)  
 Rates → [R0, R1, ... RN-1] set of rates assigned to the N users  
 f\_d → [f0, f1, ..., fN-1] set of  $f_i$  coefficients that are calculated using the approximation polynomial  
 Nt → N (number of users)  
 EbNo → Eb/No – The signal quality requirement for each transmission at the specified rate

### Function output:

Vector P = [P0, P1, ..., PN-1] set of powers assigned to users  
 If the solution vector P is valid, the function sets Flag to TRUE and returns P  
 else Flag is set to 0

3/25/2008

Dr. Ash

## CDMA Capacity Revisited – Downlink – 14 - Procedure

- Assume  $E_b/N_0 = 10^{(5/10)}$  for all transmissions –  $\rho = 0.1$ ,  $BW = 1.25$  MHz,  $P_{total} = 24$  Watts,  $\beta = 0.2$  (i.e.  $P_{ov} = 0.2 \times 24$ ,  $P_{traffic} = 24 - 0.2 \times 24 = 18$  Watts)
- Initially the system is empty (i.e. no users are connected to the base station)
- First connection request arrives - associated with a data block (number of bytes) to transmit
  - Calculate the  $f_i$  for this mobile using its location and the RF model
  - Assume we will try to assign it the maximum bit rate possible – so try the following rates in the descending order: [307.2 153.6 76.8 38.4 19.2 9.6]
  - $N_t = 1$ ; Let Rates = [307.2e3] and use the function to determine if the rate can be supported or not
    - If flag = true – solution is found – assign rate – calculate when this transmission will be finished (time = Datablock size/Rate)
    - If flag = false – try next lower rate and repeat call for function
    - If no rate is suitable – transmission can not be served – block mobile
- Repeat procedure for additional users
- When a transmission is completed – it is removed from the system variables (i.e. power is released)  $N_t$ , Rates and other variables are updated

3/25/2008

Dr. Ashraf S. Hasan Mahmoud

63

## CDMA Capacity Revisited – Downlink – Problem Statement

- Assume a CDMA system – Burst/Transmission requests are arriving to the base station according to a Poisson process with rate  $\lambda$  requests per second. Each request coming from a different mobile with a random  $(x,y)$  location (and therefore a different  $f_i$  value). The request is also associated with a random data block size ( $B_i$ , Bytes) for transmission. if:
  1. The requests are served in a blocking FCFS order – assume all burst requests that can be served starting with an empty system (you may want to check this based on the path loss model) – bursts that are delayed more than  $D_{max}$  seconds are dropped and not served.
  2. The requests are served in a non-blocking FCFS order. Bursts that can not be served immediately are placed in FCFS queue where the system attempts to serve them every time an ongoing burst is completed. Again, assume that bursts delayed for more than  $D_{max}$  seconds are dropped and not served
- Required output:
  - Throughput – time average of assigned rates (see next slide)
  - Probability of burst request dropping – Ratio of dropped burst requests to total number of number of arriving requests
  - Average access delay for a burst request
  - Etc.

3/25/2008

Dr. Ashraf S. Hasan Mahmoud

64



## CDMA Capacity Revisited – Downlink – Example (blocking FCFS)

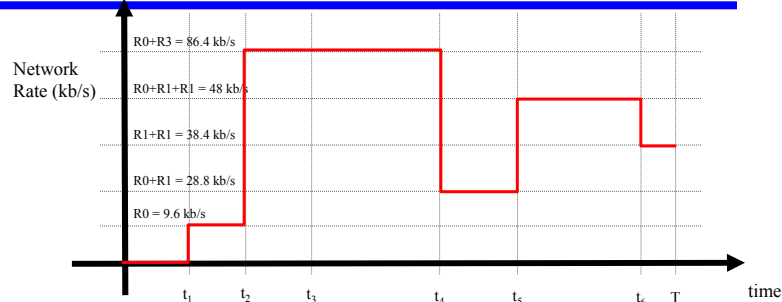

t1: Burst request 1 arrives – assigned R0 (9.6 kb/s) at t1 – zero access delay  
 t2: burst request 2 arrives – assigned R3 (76.8 kb/s) at t2 – zero access delay - total rates on downlink = R0+R3 = 86.4 kb/s  
 t3: burst request 3 arrives – could not be served – wait  
 t4: burst 2 finishes service – power released – request 3 can served (assume it did not expire) – assigned rate R1 (19.2 kb/s) – access delay for request 3 = t4-t3 – total rates on downlink = R0+R1 = 28.8 kb/s  
 t5: burst 4 arrives – assigned R1 (19.2 kb/s) at t5 – zero access delay – total rates on downlink = R0+R1+R1 = 48 kb/s  
 t6: burst 1 finishes service – power released – total rates on downlink = R1 + R1 = 38.4 kb/s  
 T: simulation time completed

Results:  
 Average throughput = area under the curve from t = 0 till t = T  
 Prob of being delayed = 1/4  
 Average access delay = (0 + 0 + (t4-t3) + 0)/4

65

## Random Access for Data Services

- Random access is suitable for bursty (intermittent variable – non constant) data applications
- Contention-based schemes
  - Originally for wireline LANS - CSMA/CD used for IEEE802.3 (Ethernet)
- Non-contention based schemes:
  - Reservation
  - Polling
- Performance measures
  - Throughput
  - Delay (packet)

3/25/2008

Dr. Ashraf S. Hasan Mahmoud

66

## Performance Measures

- Throughput
- Delay (packet)

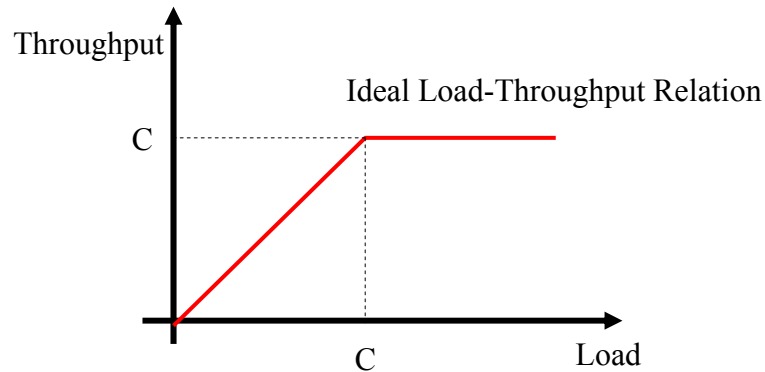

3/25/2008

Dr. Ashraf S. Hasan Mahmoud

67

## ALOHA-Based Wireless Random Access Techniques

- Pure ALOHA Protocol
  - Developed in 1971 by university of Hawaii
  - Multiple ground stations communicate to a central node
  - A station transmits when the data packet arrives
  - BS receives packet and decodes – if correct an ACK is sent back
  - if ACK is not received, station retransmits it packet after some random delay to avoid repeated collisions
  - Collision: when two packet transmissions overlap – note this model ignore errors due to the wireless link other than interference

3/25/2008

Dr. Ashraf S. Hasan Mahmoud

68

# Pure ALOHA

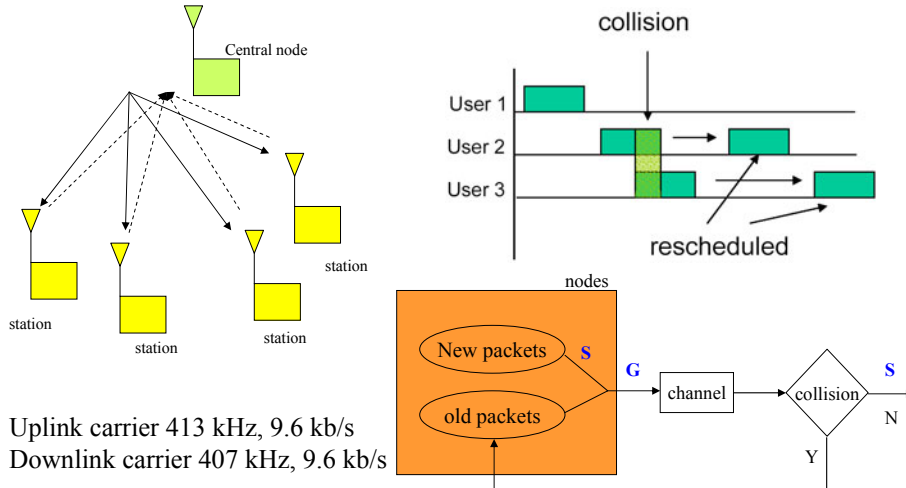

3/25/2008

Dr. Ashraf S. Hasan Mahmoud

69

# ALOHA Random Access Procedure

- **Assume**
  - **Packet transmission time: P**
  - **Total # of packet arrival (new + retransmission) ~ Poisson with rate  $\lambda$**

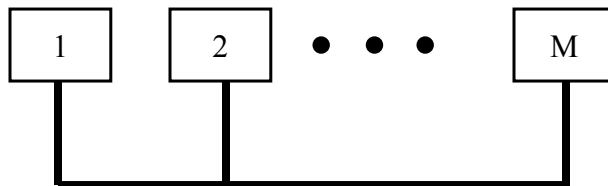

3/25/2008

Dr. Ashraf S. Hasan Mahmoud

70

## ALOHA - Throughput

- Poisson arrival (new + retransmitted) of packets:

$$\text{Prob}[k \text{ arrivals in } t \text{ sec}] = \frac{(\lambda t)^k}{k!} e^{-\lambda t}$$

- Offered Load (G): Average number of attempted packet transmissions per packet transmission time, P
- Throughput (S): Average number of successful transmissions per packet transmission time, P

3/25/2008

Dr. Ashraf S. Hasan Mahmoud

71

## Pure ALOHA - Throughput - cont'd

- Vulnerable Period

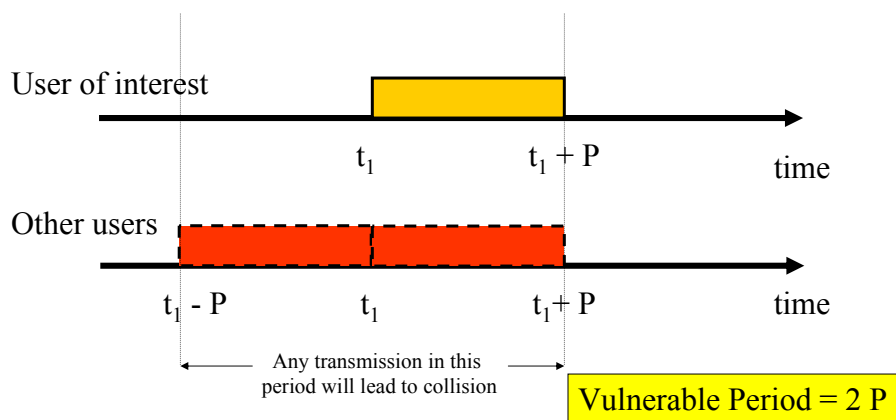

3/25/2008

Dr. Ashraf S. Hasan Mahmoud

72

## ALOHA Throughput – cont'd

- Throughput = fraction of attempted transmission that are successful (i.e. did not collide)
- Therefore,

$$S = G \times \text{Prob[ no collision in } 2P \text{ seconds]} \\ = G \times \text{Prob}[0 \text{ packet arrivals in } 2P \text{ seconds}]$$

$$= G \times \frac{(2G)^0}{0!} e^{-2G}$$

Or

$$S = G e^{-2G} \quad \text{packets/packet transmission time}$$

3/25/2008

Dr. Ashraf S. Hasan Mahmoud

73

## Slotted ALOHA

- An improvement over pure ALOHA
- Time axis is slotted
- Transmission occur only at the beginning of a time slot
- A packet arriving to buffer has to wait till the beginning of the time slot for transmission
  
- Cost: common clock signal!

3/25/2008

Dr. Ashraf S. Hasan Mahmoud

74

## Slotted ALOHA – Throughput – cont'd

- **Vulnerable Period** (note time axis is divided into slots – transmissions can only start at the beginning of a time slot)

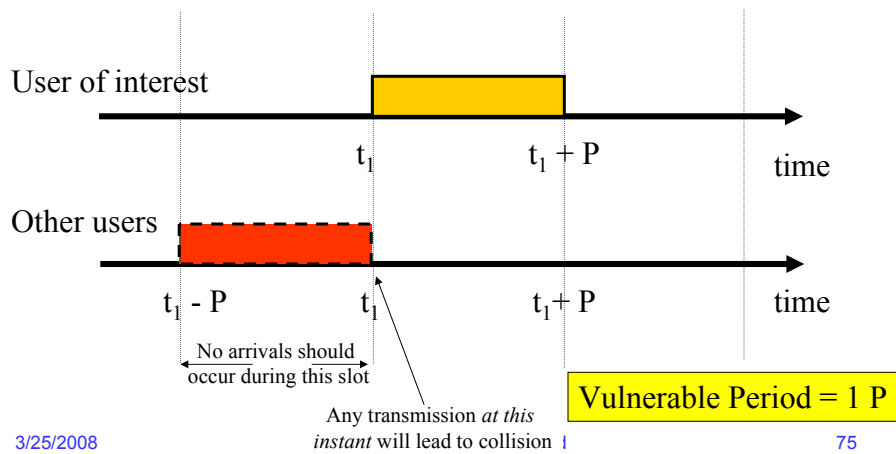

## Slotted ALOHA – Throughput

- **Throughput = fraction of attempted transmission that are successful (i.e. did not collide)**
- **Therefore,**

$$S = G \times \text{Prob}[\text{no collision in } 1 P \text{ seconds}]$$

$$= G \times \text{Prob}[0 \text{ packet arrivals in } 1 P \text{ seconds}]$$

$$= G \times \frac{(G)^0}{0!} e^{-1G}$$

Or

$$S = G e^{-1G} \quad \text{packets/packet transmission time}$$

## ALOHA – Throughput – cont'd

- **Pure ALOHA:** Max throughput,  $S = 0.5 e^{-1}$  or  $\sim 18\%$  at  $G = 1/2$
- **Slotted ALOHA:** Max throughput,  $S = e^{-1}$  or  $\sim 36\%$  at  $G = 1$

- **For Pure ALOHA:**
  - Stable operation range:  $0 < G < 0.5$
  - Unstable operation range:  $G > 0.5$
- **For Slotted ALOHA:**
  - Stable operation range:  $0 < G < 1.0$
  - Unstable operation range:  $G > 1.0$

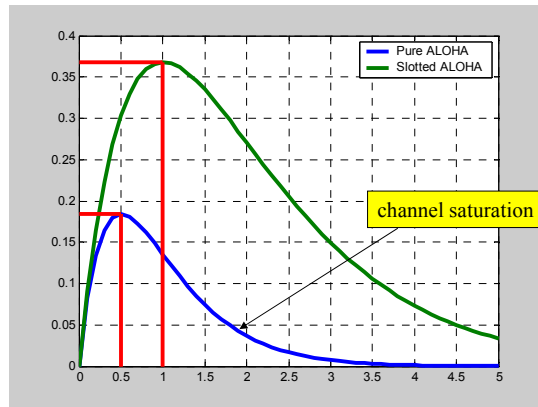

3/25/2008

Dr. Ashraf S. Hasan Mahmoud

77

## Reservation ALOHA (R-ALOHA)

- R-ALOHA = Slotted ALOHA + TDMA
- Time axis is divided into contention slots + contention-free slots
- MS sends short requests to contend for the upcoming contention-free intervals
- If reservation is successful, MS send its info (usually a much long packet) during the correspond contention-free interval
- Originally: Altair 18-19 GHz – early 1990s

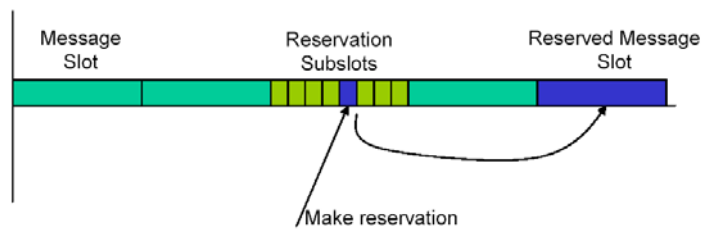

3/25/2008

## Dynamic Slotted ALOHA - Mobitex

- A version of R-ALOHA
- A mobile can transmit only during certain "free" cycles consisting of equal length slots initiated by the BS after the transmission of "FREE" frame

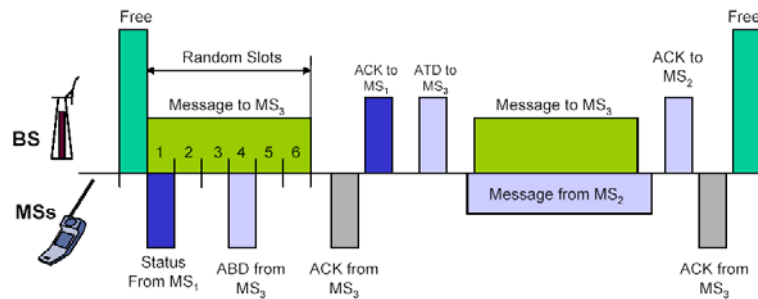

## Packet Reservation Multiple Access (PRMA)

- A scheme to integrate voice (periodic) and low-bit data (non-periodic)
- Once a user acquires a slot it is reserved until it is explicitly released (a NULL packet) – no need for repeated asseveration – efficient for long/continuous bursts
- Protocol can utilize the discontinuous nature of speech – voice activity detector (VAD)
- Details: D. Goodman, S.X. Wei, "Efficiency of Packet Reservation Multiple Access," IEEE Transaction on Vehicular Technology, Vol. 40, No. 1, February 1991, pp. 170-176.

3/25/2008

Dr. Ashraf S. Hasan Mahmoud

80



## Reservation in GPRS

---

- A single 200 kHz carrier – 8 times slots
- Time slot carries
  - 9.6 kb/s (standard),
  - 14.4 kb/s (enhanced), or
  - 21.4 kb/s (for no error coding)
- A maximum bit rate of  $8 \times 21.4 = 171.4$  kb/s
- MAC (Uplink):
  - MS sends reservation request to BS
  - BS sends notification indicating the allocation for an uplink channel
  - MS can transmit data
- MAC (Downlink):
  - BS sends notification to MS indicating allocation on downlink
  - MS monitors that downlink channel for receiving data

3/25/2008

Dr. Ashraf S. Hasan Mahmoud

81

## CSMA-Based Wireless Random Access Techniques

---

- Carrier-Sense Multiple Access (CSMA) or Listen Before Talk (LBT) schemes
- Unlike ALOHA-based protocol, users “sense” the channel to determine whether it is free or not
- Reduce chances of collision

3/25/2008

Dr. Ashraf S. Hasan Mahmoud

82

## Non-persistent CSMA

- Station does not sense channel continuously while it is busy
- If (channel == busy) then wait random time before sensing again
- LABEL: If (channel == idle) {  
    transmit packet  
  }  
  else {  
    wait random time (backoff)  
    when backoff expires Goto LABEL  
  }

3/25/2008

Dr. Ashraf S. Hasan Mahmoud

83

## p-persistent CSMA

- Time is divided into slots
- Slot = maximum propagation delay
- If station has info to send

```
if (channel == idle){  
  tx info with probability p  
  with probability q = 1-p postpone action till next slot  
}  
else{  
  continue sensing channel till it becomes free  
  start procedure again  
}
```

- Algorithm is repeated for next slot

3/25/2008

Dr. Ashraf S. Hasan Mahmoud

84

## 1-persistent CSMA

- A special case of p-persistent
- Info is transmitted as soon as the channel is sensed to be idle
- If an ACK is not received within a specified time:
  - Station waits a random time period
  - Resumes listening to channel to resend info

3/25/2008

Dr. Ashraf S. Hasan Mahmoud

85

## CSMA Protocols - Summary

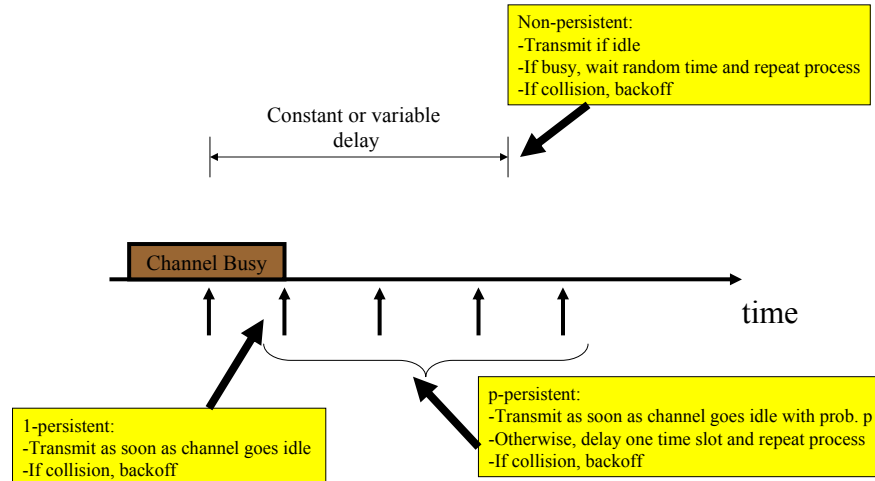

3/25/2008

Dr. Ashraf S. Hasan Mahmoud

86

## Throughput of CSMA Protocols

- Unslotted Nonpersistent CSMA

$$S = \frac{Ge^{-aG}}{G(1+2a) + e^{-aG}}$$

- Slotted Nonpersistent CSMA

$$S = \frac{aGe^{-aG}}{1 - e^{-aG} + a}$$

- Unslotted 1-Persistent CSMA

$$S = \frac{G[1 + G + aG(1 + G + aG/2)]e^{-G(1+2a)}}{G(1+2a) - (1 - e^{-aG}) + (1 + aG)e^{-G(1+a)}}$$

- Slotted 1-Persistent CSMA

$$S = \frac{G[1 + a - e^{-aG}]e^{-G(1+a)}}{(1+a)(1 - e^{-aG}) + ae^{-G(1+a)}}$$

$a = T_{prop}T_p$   
 $T_{prop}$  = propagation delay  
 $T_p$  = packet/frame transmission time

3/25

Dr. Ashraf S. Hasan Mahmoud

87

## Throughput Figures for CSMA Protocols – cont'd

- For  $a = 0.01$
- How does the performance look like for  $a \sim 1$ ? What about  $a \gg 1$ ?
- Check the answer in figure 4.19

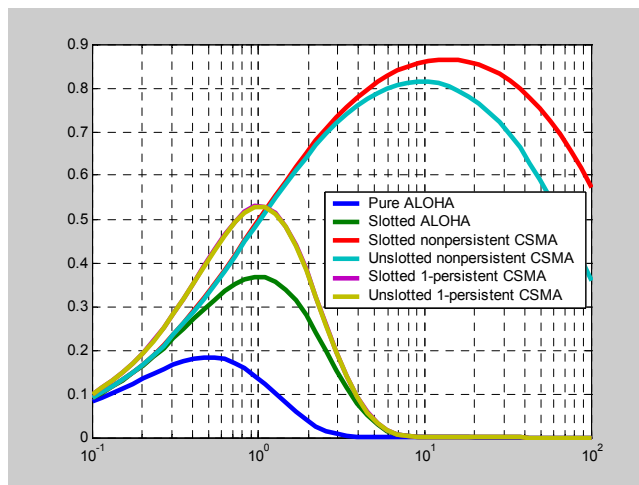

3/25/2008

Dr. Ashraf S. Hasan Mahmoud

88

## Delay Analysis for ALOHA

- For a given packet transmission, the overall delay,  $D$ , is given by  

$$D_p = T_p + T_{prop} + T_{proc} + T_{ack} + T_{prop}, \text{ or}$$

$$D_p \approx T_p + 2T_{prop}$$

where  $T_p$  = time to transmit a packet  
 $T_{prop}$  = propagation time  
 $T_{ack}$  = time to transmit ACK/NACK  
 $T_{proc}$  = processing time at the receiver

Let the probability of successful transmission =  $P_s$

Then Probability of needing  $n$  successive transmissions to one packet is given by

Prob[  $n$  transmission per packet ] =  $(1-P_s)^{n-1}P_s$   $n=1,2, \dots$

The average number of transmissions needed to deliver one packet,  $N_{avg}$ , is given by

$$N_{avg} = \sum n \times \text{Prob} [ n \text{ transmission per packet } ] \text{ for } n=1, 2, 3, \dots$$

$$= 1/P_s$$

Overall average delay per packet is given by

$$\text{Delay} = N_{avg} \times D_p = T_p (1+2a)/P_s$$

### Remember (refer to previous ALOHA slides)

For pure ALOHA:  $P_s = \exp(-2G)$

For slotted ALOHA:  $P_s = \exp(-G)$

3/25/2008

Dr. Ashraf S. Hasan Mahmoud

89

## Delay Analysis for ALOHA

- For pure ALOHA:
  - At  $S = S_{max} = 18\%$
  - $G = 0.5$ , and
  - $D = (1+2a) \exp(1) = 2.7*(1+2a)$
- For slotted ALOHA:
  - At  $S = S_{max} = 36\%$
  - $G = 1$ , and
  - $D = (1+2a) \exp(1) = 2.7*(1+2a)$

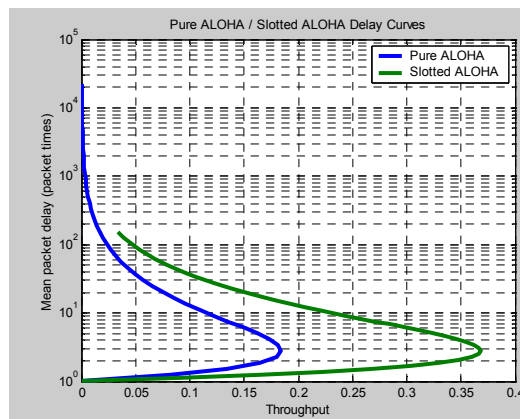

3/25/2008

Dr. Ashraf S. Hasan Mahmoud

90

## Delay Figure for CSMA Protocols

- Delay Figure

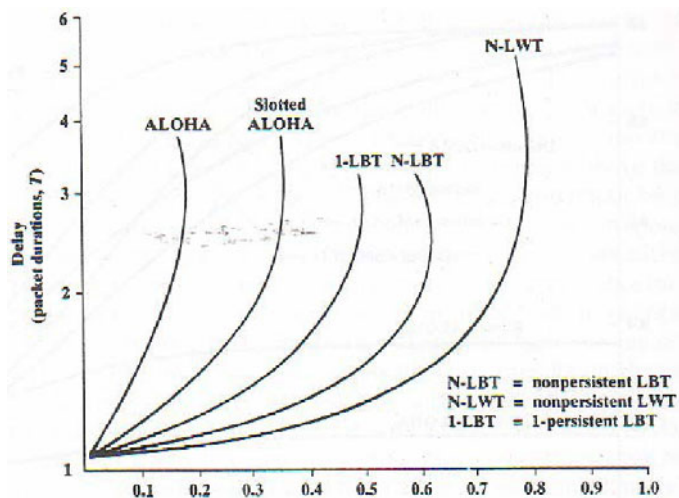

3/25/2008

Dr. Ashraf S. Hasan Mahmoud

91

## Hidden Terminal Problem

- Two terminals communicating in with one access point (AP)
  - Out of the coverage of each other  $\rightarrow$  can not sense whether the channel is idle or busy
  - Degrades CSMA performance because of increased collisions

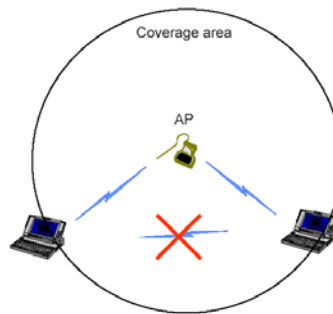

3/25/2008

Dr. Ashraf S. Hasan Mahr

## Capture Effect

- Collision between packets does not necessarily mean both packets are corrupted – the one arriving at with the highest  $E_b/N_0$  may survive
- The AP detects the packet from the closest station
- This increases throughput – higher than predicted – why?
- Capture can improve throughput and reduce delay for slotted ALOHA and non-persistent CSMA – See example in book by Pahlavan

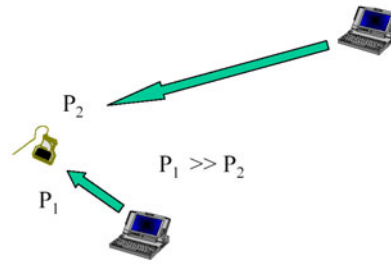

3/25/2008

Dr. Ashraf S. Hasan Mahmoud

93

## Example 1:

- A centralized network providing a maximum of 10 Mbps and services a large set of user terminal with pure ALOHA protocol
- a) What is the maximum throughput for network?
- b) What is the offered traffic in the medium and how is it composed?

### Solution:

- a)  $S_{max} = 18\% \rightarrow$  Network throughput =  $0.18 \times 10 = 1.8$  Mbps
- b) At  $S = S_{max}$ ,  $G = 0.5$ ,
  - $\rightarrow$  Offered load =  $0.5 \times 10 = 5$  Mbps
  - 1.8 Mbps of delivered packets
  - + 3.2 Mbps of collided packets

3/25/2008

Dr. Ashraf S. Hasan Mahmoud

94

## Example 2:

---

- a) Determine the transfer time of a 20 kB file with a mobile data network with a transmission rate of 10 kb/s?
- b) Repeat for an 802.11 WLAN operating at 2 Mb/s
- c) What is the length of the file that the WLAN of part (b) can carry in the time that mobile data service of (a) carries its 20 kB file?

3/25/2008

Dr. Ashraf S. Hasan Mahmoud

95

## Example 2: cont'd

---

- a) This file limit is used by ARDIS and Mobitex  
Time =  $20 \text{ (kB)} \times 8 \text{ (b/B)} / 10 \text{ kb/s} = 16.38$   
seconds
- b) An IEEE 802.11 network operating at 2 Mb/s would transfer the file in  $20 \times 1024 \times 8 / 2 \times 10^6 = 81.9$  msec
- c) In 16.38 seconds, the IEEE 802.11 WLAN would transfer =  $16.38 \times 2 \times 10^6 / 1024 / 1024 = 3.9$  MB file

3/25/2008

Dr. Ashraf S. Hasan Mahmoud

96



## CSMA with Collision Detection (CSMA/CD)

- Used for wired LANs
- Adopted in the IEEE802.3 (Ethernet) standard
- Can support up to Giga bits per second
- The MAC protocol
  - 1) Wait until the channel is idle
  - 2) Transmit and listen while transmitting
  - 3) If collision, stop packet, transmit a jam signal, and then wait for a random delay
  - 4) Goto (1)
- Protocol gives up transmission after 16 attempts

3/25/2008

Dr. Ashraf S. Hasan Mahmoud

Note: no feedback mechanism for CSMA/CD is required

With 1-persistent

## Binary Exponential Back-off

- For a terminal that have collided  $n$  ( $n=1, \dots, 15$ ) successive times:
  - Choose a random number  $K$  from set  $\{0, 1, 2, \dots, 2^{n-1}\}$ , where  $m = \min(10, n)$  – uniform distribution
  - Wait for  $K$  time slots
  - E.g. after first collision – terminal waits either 0 or 1 time slot – after 2<sup>nd</sup> collision – terminal waits either 0, 1, 2, or 3 time slots, and so on
- The probability of repeated collisions is reduced significantly
  - **E.g.** What is the probability that two terminals will collide the forth time if they have collided 3 consecutive times?
  - **Soln:** = Prob[both choose the same random number for the 4<sup>th</sup> time] =  $8 \times 1/8 \times 1/8 = 1/8$

3/25/2008

Dr. Ashraf S. Hasan Mahmoud

98

## CDMA/CD – Performance

- Time slot = 2 X Tprop
  - The time which guarantees that all terminals know (receives the jamming signal) of the collision
  - By 3 X Tprop – the channel is clear
  - Efficiency of CSMA/CD  $\approx 1/(1+3a)$  – where  $a = T_{prop}/T_{frame}$
- Prob[ 1 terminal transmits ] =  $\beta = Np(1-p)^{N-1}$   
 This probability is maximized if  $p = 1/N$   
 For large N  $\rightarrow$  Prob[ 1 terminal transmits ] =  $\beta \approx 0.4$   
 Let A be number of time slots wasted till a successful tx goes through, therefore  $A = \beta \times 0 + (1 - \beta) \times (1 + A)$   
 $\rightarrow A = 1.5$   
 Therefore Efficiency =  $T_{frame}/(T_{frame} + 1.5 \times 2 \times T_{prop})$ , or  
 $= 1/(1+3a)$   
 Actual performance is closer to =  $1/(1+5a)$

3/25/2008

Dr. Ashraf S. Hasan Mahmoud

99

## CSMA for Wireless Links

- Collision detection is not possible – Why?
- Collision avoidance is used  $\rightarrow$  CSMA/CA
- Employed by IEEE802.11
  - IFS: Intra-frame spacing – intervals between CWs
  - CW: contention window: contention and tx of packets
  - Backoff counter

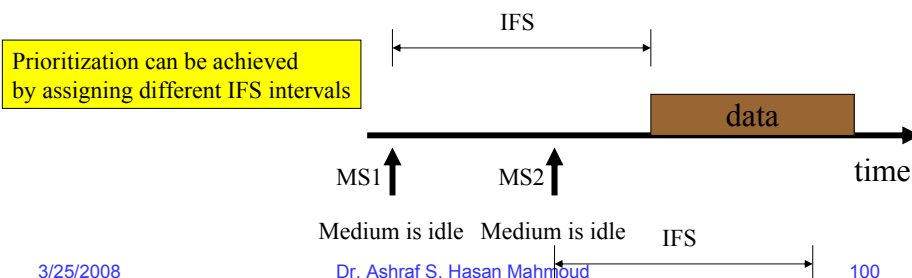

3/25/2008

Dr. Ashraf S. Hasan Mahmoud

100

## Request-to-Send and Clear-to-Send

- A third alternative for collision avoidance
- Employed by IEEE802.11
- No contention

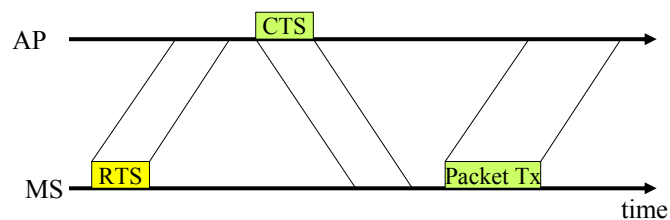

3/25/2008

Dr. Ashraf S. Hasan Mahmoud

101

## Integration of Data in Voice Networks

- CDPD: Mobile data over AMPS
  - Overlaid packet data service supporting data rates up to 19.2 kb/s
  - Unused AMPS channels are into random access channels
  - Air-interface and physical layer for CDPD and AMPS are different
- GPRS: Mobile data over GSM
  - Can support up to 170 kb/s
  - Same physical layer as GSM
  - Traffic over GPRS is routed to the packet switched network rather than PSTN

3/25/2008

Dr. Ashraf S. Hasan Mahmoud

102

## Integration of Data in Voice Networks – Capacity Issues

---

- General approach: dedicate  $n$  ( $n=0, 1, \dots, c$ ) channels out of  $c$  for data use
  - Data traffic can also use the other  $c-n$  voice channels when channels are idle
  - Refer to analysis in the book
    - Average active period where a channel is available for data
    - Mean length of blackout period
- For TDMA
  - Movable Boundary TDMA scheme with silence detection

3/25/2008

Dr. Ashraf S. Hasan Mahmoud

103

## Integration of Voice in Data Networks

---

- Voice is a synchronous traffic
  - Delay intolerable – voice packets with delay greater than  $T_{\text{threshold}}$  are useless
  - Delay jitter
    - Receiver may buffer packets to compensate for jitter

3/25/2008

Dr. Ashraf S. Hasan Mahmoud

104

## Definition of Delay Jitter

- End-to-End Delay = Minimum Network Delay + Delay Jitter – note packets are transmitted at a constant rate

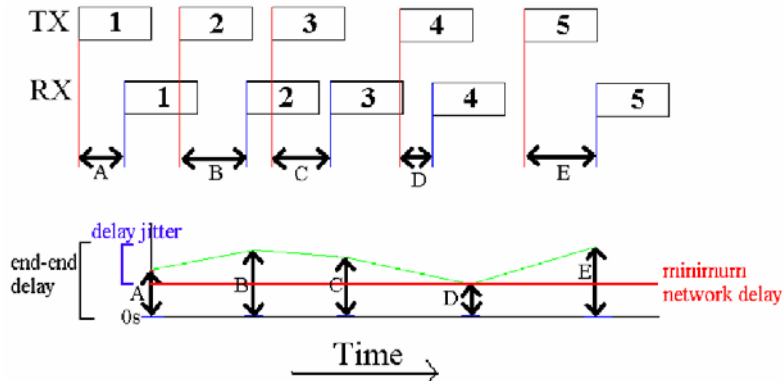

3/25/2008

Dr. Ashraf S. Hasan Mahmoud

105

## Integration of Voice in Data Networks - Example

- **Source:** A. Zahedi and K. Pahlavan, "Capacity of a wireless LAN with voice and data services," IEEE Transactions of Communications, July 2000, pp.1160-1170.

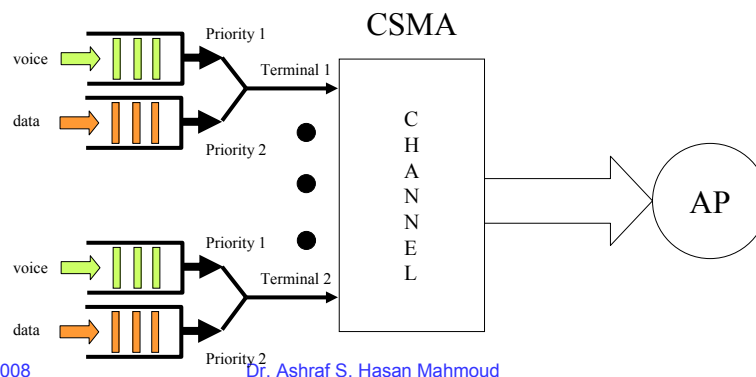

3/25/2008

Dr. Ashraf S. Hasan Mahmoud

106

## Integration of Voice in Data Networks

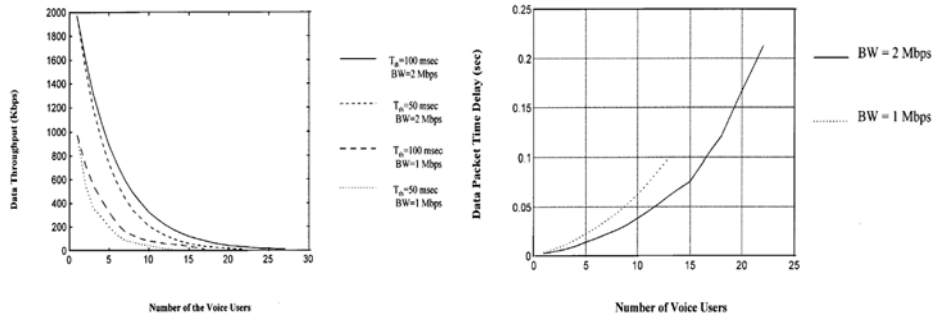

(a) Throughput of data versus number of voice users for variety of thresholds for acceptable delay in voice packets  
 (b) Data packet time delay versus number of voice users

**Source:** A. Zahedi and K. Pahlavan, "Capacity of a wireless LAN with voice and data services," IEEE Transactions of Communications, July 2000, pp.1160-1170.

107

## Jitter in VoIP on WLANs

- Objective: to playback the real-time traffic with no jitter (as if CBR)
- Method: use jitter compensation buffer at receiver
- Operations:
  - Packets exceeding delay deadline are dropped
  - Play packet in its slot
  - Reorder packets if needed

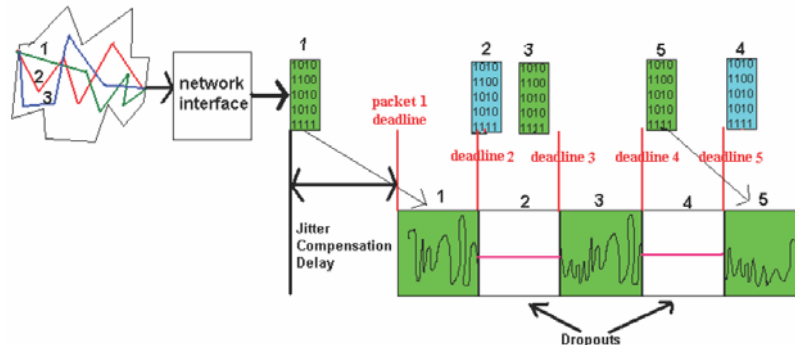

108