

Enhancements and Performance Evaluation of Wireless Local Area Networks

Jiaqing Song and Ljiljana Trajkovic

Communication Networks Laboratory
Simon Fraser University
Burnaby, BC, Canada
E-mail: {jsong, ljilja}@cs.sfu.ca

Abstract

Unlike wired networks that can provide large bandwidth, the bandwidth of wireless local area networks (WLANs) is rather limited because they rely on an inexpensive, but error prone, physical medium (air). Hence, it is important to improve their loss performance.

In this paper, we investigate several methods for improving the performance of WLANs. We survey the current research literature dealing with improving performance on various wireless network layers. We describe OPNET implementations of three approaches: tuning the physical layer related parameters, tuning the IEEE 802.11 parameters, and using an enhanced link layer (media access control) protocol. Finally, we describe several simulation scenarios and present simulation results that demonstrate the effectiveness of the three approaches.

Keywords: Wireless local area networks, media access control, back-off algorithm, IEEE 802.11.

1. Introduction

The IEEE 802.11 standard [1] defines the protocol and compatible interconnections of data communication equipment via the “air” (radio or infrared) in a local area network (LAN). It encompasses the physical (PHY) and the media access control (MAC) layers of the ISO seven-layer network model.

Within the MAC layer, Distributed Coordination Function (DCF) is used as a fundamental access method, while Point Coordination Function (PCF) is optional. DCF is also known as Carrier Sense Multiple Access with Collision Avoidance (CSMA/CA) protocol. It is an asynchronous access method based on the contention for the usage of shared channels. PCF provides a contention-free access mechanism through the RTS/CTS (Request to Send/Clear to Send) exchange. The IEEE 802.11 protocol also includes authentication, association and re-association services, an optional encryption/decryption procedure, power management, and a point coordination function for time-bounded transfer of data.

There are several known problems with WLANs. The WLAN media is error prone and the bit error rate (BER) is very high compared to the BER of wired networks. In addition, Carrier Sensing is difficult in wireless networks because a station is incapable of listening to its own transmissions in order to detect a collision. The Hidden Terminal problem also decreases the performance of a WLAN.

This paper is organized as follows. In Section 2, we describe OPNET implementation of WLAN models. In Section 3, we survey the existing methods for improving the WLAN

performance. In Sections 4, 5, and 6, we describe OPNET implementation and illustrate that WLAN performance can be improved by tuning the physical layer related parameters, IEEE 802.11 parameters, and by using enhanced media access control protocol. We conclude with Section 7.

2. OPNET WLAN models

WLAN models are part of the standard OPNET Modeler 8.0.c library. The OPNET WLAN models [2] include:

WLAN station: The WLAN station node model (Figure 1) is an IEEE 802.11 wireless LAN station. The node model consists of an ON/OFF (active/inactive) traffic source, a sink, a wireless LAN interface, and a receiver/transmitter pair.

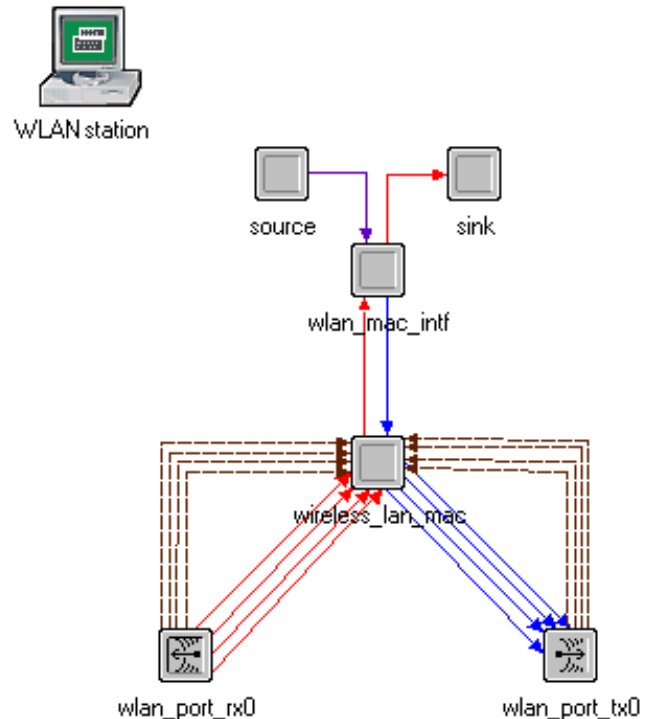

Figure 1: OPNET node model: WLAN Station.

WLAN workstation and server: The WLAN workstation node model (Figure 2) is a workstation with client-server applications running over TCP/IP and UDP/IP. The WLAN server node model (Figure 2) is a server with applications running over TCP/IP or UDP/IP. Both nodes support IEEE 802.11 connections at 1 Mbps, 2 Mbps, 5.5 Mbps, or 11 Mbps. The operational speed is determined by the data rate of the connecting link.

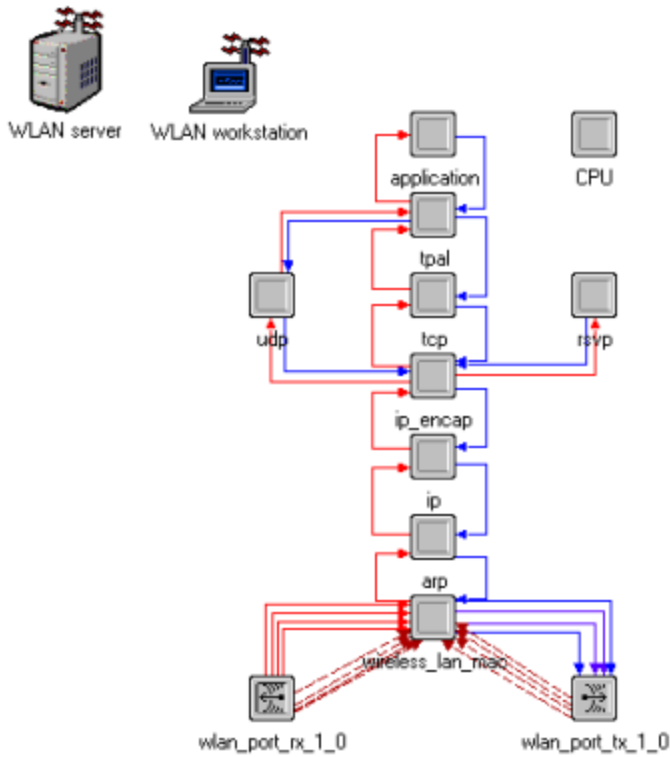

Figure 2: OPNET node model: WLAN Workstation and Server.

WLAN Access Point (wireless router): The WLAN access point node model (Figure 3) is a wireless LAN based router with an Ethernet interface. It is used as a router in wireless networks and it connects the wireless network to wired networks.

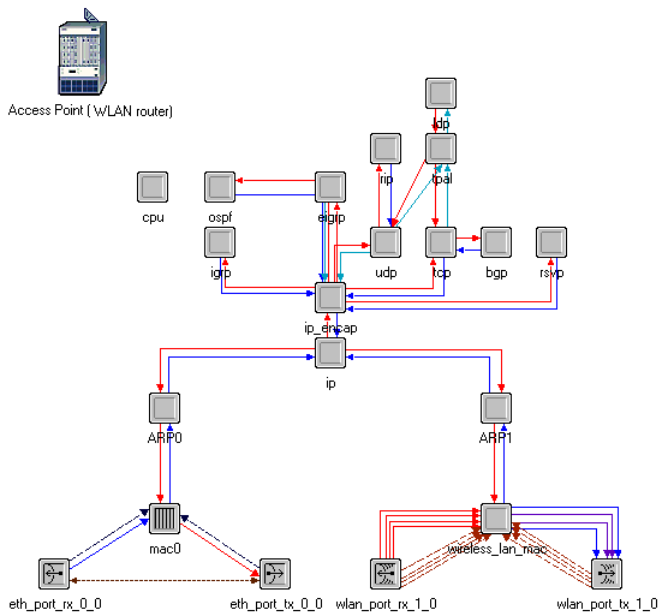

Figure 3: OPNET node model: WLAN Access Point.

Independent Basic Service Set: The IEEE 802.11 WLAN consists of a Basic Service Set (BSS) (Figure 4). A BSS is a set of stations that communicate with each other. It is called an independent BSS (ad-hoc network) if every station in the BSS communicates directly with other stations and if the BSS is not connected to wired networks.

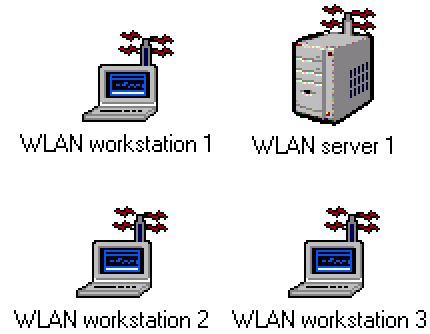

Figure 4: OPNET scenario: WLAN Independent BSS.

Infrastructure Basic Service Set: When an Access Point (wireless router) is present in the independent BSS, the stations in the BSS do not communicate with each other directly. The access point relays all communications. Therefore, the BSS is called an infrastructure BSS (Figure 5).

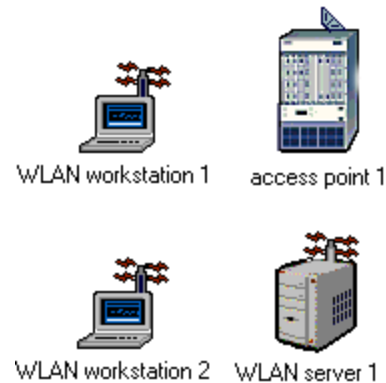

Figure 5: OPNET scenario: WLAN Infrastructure BSS.

3. Performance enhancement of WLANs

Methods for improving WLANs performance employ:

- Enhanced hardware in the Physical Layer to achieve better physical (PHY) layer parameters, such as shorter Slot Time and shorter Short Inter-Frame Space (SIFS) [2].
- Better tuning of WLAN parameters, such as Fragmentation Threshold and RTS Threshold [2].
- Adaptive (rather than basic) back-off algorithms in the MAC layer [3]-[5].
- Proxy approaches in the link-layer, such as snoop protocol [6], [7], and TULIP [8].
- Split-connection approaches, such as I-TCP [9] or M-TCP [10].
- Other link-layer approaches [11], [12], such as AIRMAIL [13].

4. Tuning the WLAN physical layer parameters

In this section, we explore the effect of physical (PHY) layer parameters. Three OPNET pre-defined types of PHY layers are: "Frequency Hopping", "Direct Sequence", and "Infra Red". OPNET does not offer customized PHY parameters.

4.1 OPNET Implementation

We modified the OPNET *wlan_mac* process model and introduced four parameters in the WLAN parameters table: Slot Time, SIFS Time, Minimum Contention Window, and Maximum Contention Window. They are enabled only if the “Customized” option is selected for “Physical Characteristics” (Figure 6).

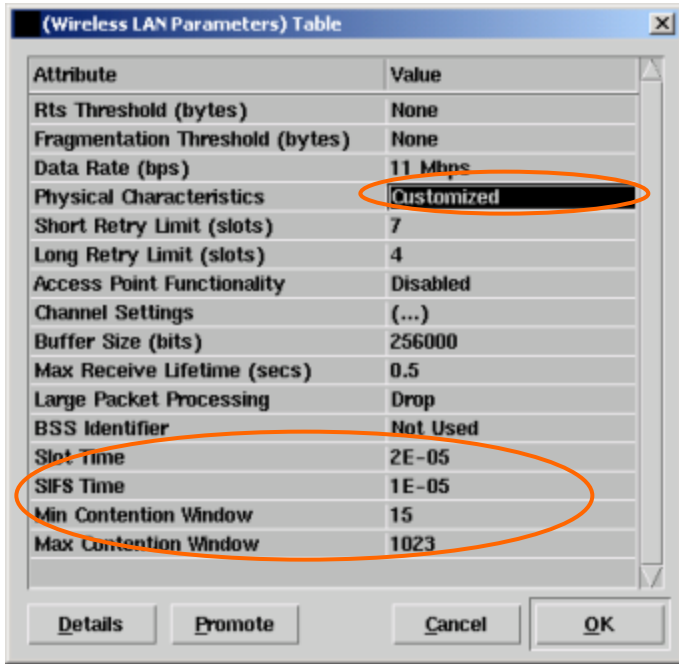

Figure 6: The customized physical layer parameters.

4.2 Scenarios and settings

We employed a simple scenario with two WLAN stations (Figure 7). The two stations send data at an average rate of 820 kbps. The *wlan_station* (Figure 1) is chosen because it has no TCP and Higher Layers. Without being affected by TCP or higher layers, the *wlan_station* more accurately reflects the performance of MAC layer protocols. Traffic parameters are listed in Table 1.

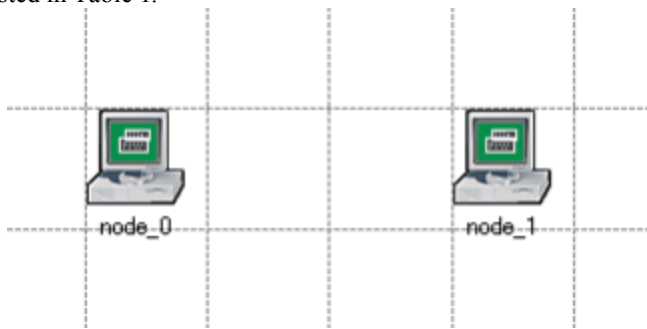

Figure 7: OPNET scenario with two WLAN stations.

Attribute	Value
Packets sending start time (s)	constant (2)
Packets sending stop time (s)	never
Packet inter-arrival time (s)	exponential (0.01)
Packet size (bytes)	exponential (1,024)
Segmentation size (bytes)	no segmentation

Table 1: Traffic generation parameters.

4.3 Slot Time and SIFS

The first set of simulation scenarios demonstrate the effect of Slot Time and Short Inter-frame Space (SIFS) on the WLAN performance. Parameters for the two simulation scenarios are given in Table 2.

	Scenario 1	Scenario 2
PHY characteristics	Frequency hopping	Customized
Slot time (s)	5.0E-05	2.0E-05
SIFS (s)	2.8E-05	1.0E-05
Min contention window size	15	15
Max contention window size	1,023	1,023
WLAN bandwidth (bps)	11 M	11 M
WLAN buffer size (bits)	256 k	256 k

Table 2: Slot Time and SIFS parameters for the two simulation scenarios.

During simulations, the *media access delay* in *node_0* is collected. The *media access delay* is the sum of queue and contention delays of data packets received by the WLAN MAC layer from the higher layer. For each packet, the delay is recorded when the packet is sent to the physical layer for the first time [2].

The simulation results (Figure 8) indicate that smaller Slot Time and SIFS values can decrease the average media access delay, and, hence, improve the performance of the wireless network. However, network hardware should be able to support these smaller Slot Time and SIFS values.

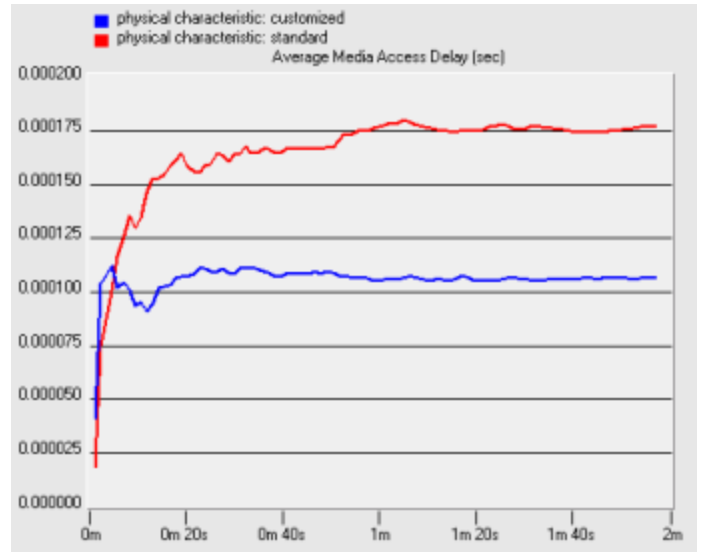

Figure 8: Average media access delay as a function of Slot Time and SIFS.

4.4 Min Contention Window

The second set of simulation scenarios demonstrates the effect of Min Contention Window on the average media access delay. Simulation parameters are listed in Table 3.

The simulation results (Figure 9) indicate that the performance of the wireless network can be improved by setting Min Contention Window to a smaller value in the case when there are few WLAN stations in the network.

	Scenario 3	Scenario 4
PHY characteristic	Customized	Customized
Slot time (s)	5.0E-05	5.0E-05
SIFS (s)	2.8E-05	2.8E-05
Min contention window size	7	63
Max contention window size	1,023	1,023
WLAN bandwidth (bps)	11 M	11 M
WLAN buffer size (bits)	256 k	256 k

Table 3: Min Contention Window parameters for the two simulation scenarios.

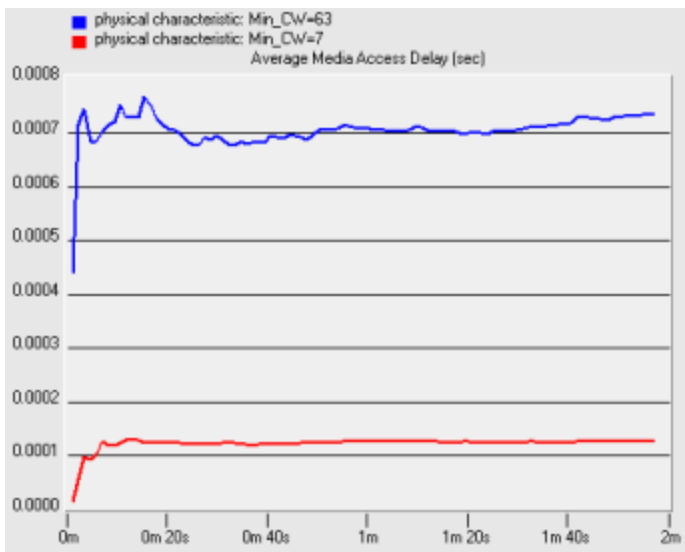

Figure 9: Average media access delay as a function of Min Contention Window.

5. Tuning the WLAN parameters

Fragmentation Threshold is an important parameter that affects WLAN performance. It is used to improve the WLAN performance when the media error rate is high. In this section, we illustrate the effect of Fragmentation Threshold on the WLAN performance.

5.1 Implementation of Packet Error Generator (PEG)

We developed a Bit Error Rate (BER) generator (the wireless channel in the original OPNET WLAN model is error-free) and integrated it into the OPNET *wlan_station* model. The Packet Error Generator (PEG) (Figure 10) can operate in three modes:

- *Disabled*: The PEG does not introduce errors into the wireless channel.
- *Bit Error Mode*: The PEG counts and calculates the total number of bits received from other stations. Once that number reaches the specified Bit Error Rate threshold, the

PEG destroys the current packet and reports the loss to the MAC layer.

- *Packet Error Mode*: The PEG counts the total number of packets received from other stations. Once that number reaches the specified Packet Error Rate threshold, the PEG destroys the current packet and reports the loss to the MAC layer.

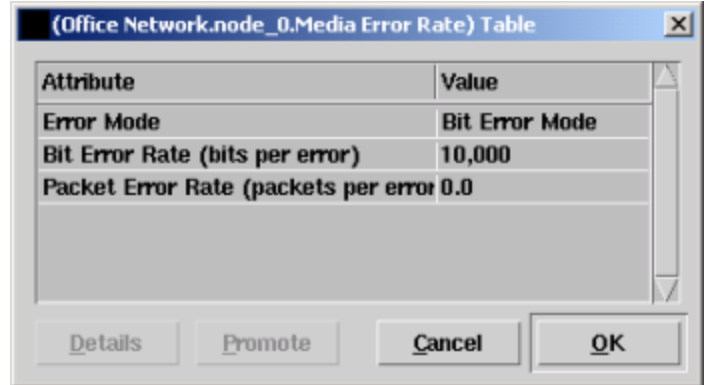

Figure 10: Packet Error Generator (PEG).

5.2 Scenarios and settings

A simple scenario with two WLAN stations was shown in Figure 7. The two stations send data at an average rate of 820 kbps. Traffic attributes were listed in Table 1.

5.3 Simulation results

To demonstrate the effects of Fragmentation Threshold, we employed nine simulation scenarios with various combinations of values for Bit Error Rate and Fragmentation Threshold. During simulations, the *throughput* of *node_0* is collected for analysis. The *throughput* is the bit rate sent to the higher layer. It represents the rate of data successfully received from other stations [2].

For the first three simulation scenarios, parameters for Fragmentation Threshold are listed in Table 4. The simulation results (Figure 11) indicate that for low bit error rates (2×10^{-5}), various fragmentation thresholds (256 bytes, 512 bytes, or no fragmentation limit) have no significant effect on the WLAN performance.

	Scenario5	Scenario6	Scenario7
Error Mode	Bit Error Mode	Bit Error Mode	Bit Error Mode
Bits Error Rate (1/bits)	1/50,000	1/50,000	1/50,000
Fragmentation Threshold	None	256 bytes	512 bytes
WLAN bandwidth (bps)	11 M	11 M	11 M
WLAN buffer size (bits)	256 k	256 k	256 k
Max receive lifetime (s)	0.5	0.5	0.5
Short retry limit (slots)	7	7	7
Long retry limit (slots)	4	4	4
PHY characteristic	Frequency hopping	Frequency hopping	Frequency hopping

Table 4: Effect of Fragmentation Threshold: parameters for simulation scenarios 5, 6, and 7.

	hopping	hopping	hopping
--	---------	---------	---------

Table 5: Effect of Fragmentation Threshold: parameters for simulation scenarios 8, 9, and 10.

The final set of parameters for Fragmentation Threshold is listed in Table 6. The simulation results (Figure 13) indicate that for relatively low bit error rates (2×10^{-6}), a commonly used fragmentation threshold (256 bytes) or using no fragmentation has no effect on the performance of the network. When the fragmentation threshold is very small (16 bytes), the WLAN performance deteriorates because of the heavy packet overhead.

	Scenario 11	Scenario 12	Scenario 13
Error Mode	Bit Error Mode	Bit Error Mode	Bit Error Mode
Bits Error Rate (1/bits)	1/500,000	1/500,000	1/500,000
Fragmentation Threshold	None	16 bytes	256 bytes
WLAN bandwidth (bps)	11 M	11 M	11 M
WLAN buffer size (bits)	256 k	256 k	256 k
Max receive lifetime (s)	0.5	0.5	0.5
Short retry limit (slots)	7	7	7
Long retry limit (slots)	4	4	4
PHY characteristic	Frequency hopping	Frequency hopping	Frequency hopping

Table 6: Effect of Fragmentation Threshold: parameters for simulation scenarios 11, 12, and 13.

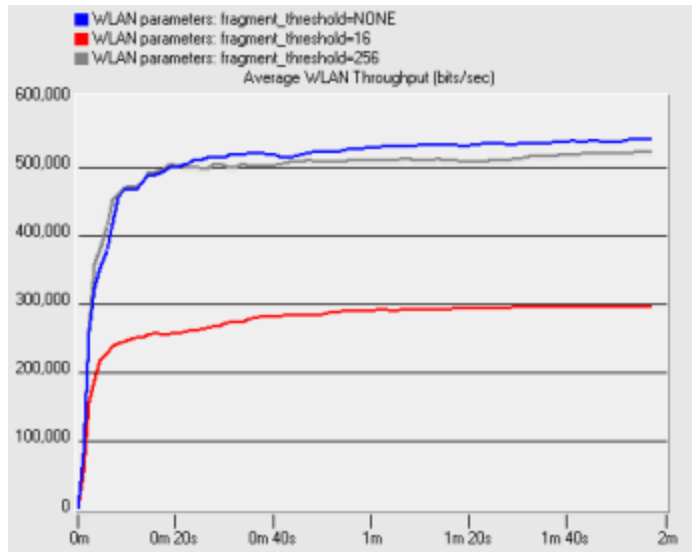

Figure 13: Effect of Fragmentation Threshold: average throughput for scenarios 11, 12, and 13.

6. Performance tune-up by using adaptive back-off
 We also examined the adaptive back-off mechanism called Distributed Contention Control (DCC) [3]. It is used for the adaptive reduction of contention in a WLAN that utilizes random access MAC protocols. This mechanism can be implemented on top of the existing access scheduling protocol (DCF) and does not introduce additional overhead.

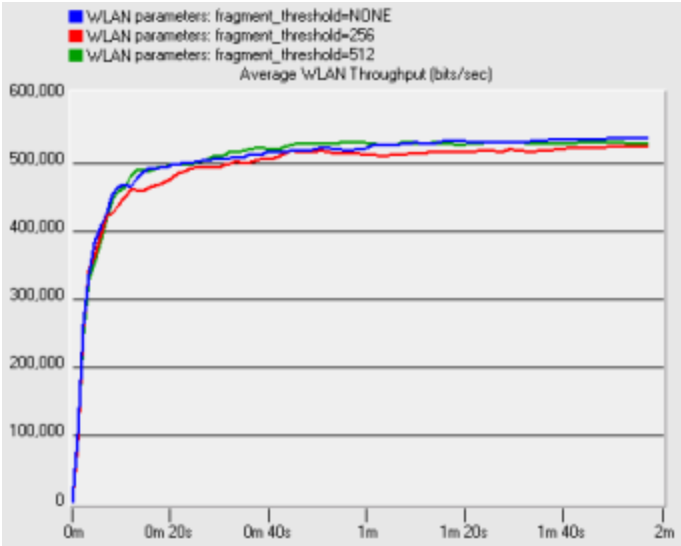

Figure 11: Effect of Fragmentation Threshold: average throughput for scenarios 5, 6, and 7.

The Fragmentation Threshold parameters used for the next set of simulations are listed in Table 5. The simulation results (Figure 12) indicate that when the bit error rate is relatively high (10^{-4}), a small fragmentation threshold (256 bytes or 512 bytes) can significantly improve WLAN performance.

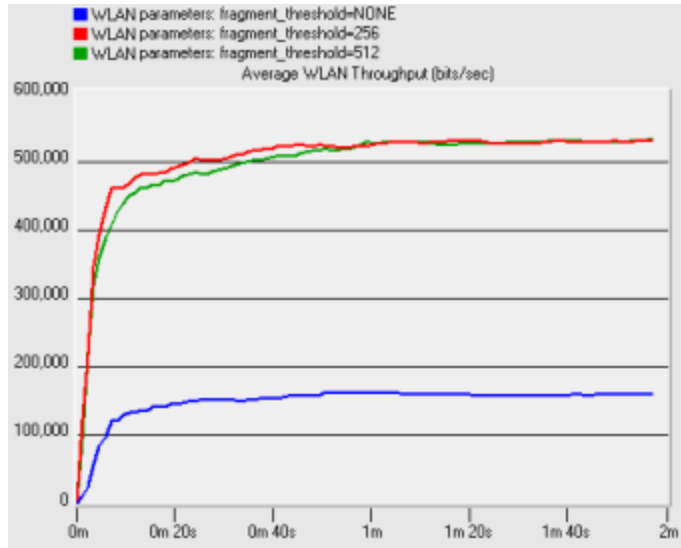

Figure 12: Effect of Fragmentation Threshold: average throughput for scenarios 8, 9, and 10.

	Scenario 8	Scenario 9	Scenario 10
Error Mode	Bit Error Mode	Bit Error Mode	Bit Error Mode
Bits Error Rate (1/bits)	1/10,000	1/10,000	1/10,000
Fragmentation Threshold	None	256 bytes	512 bytes
WLAN bandwidth (Mbps)	11	11	11
WLAN buffer size (bits)	256 k	256 k	256 k
Max receive lifetime (s)	0.5	0.5	0.5
Short retry limit (slots)	7	7	7
Long retry limit (slots)	4	4	4
PHY characteristic	Frequency	Frequency	Frequency

The main idea of the adaptive back-off mechanism is to estimate the contention level of the shared channel by calculating the slot utilization ratio (Figure 14). When a WLAN station detects a high contention level in the shared channel, which implies a

possible collision if the station sends the packet immediately, it triggers the Virtual Collision Procedure and it will perform back-off instead of sending the packet. Thus, a possible collision is avoided.

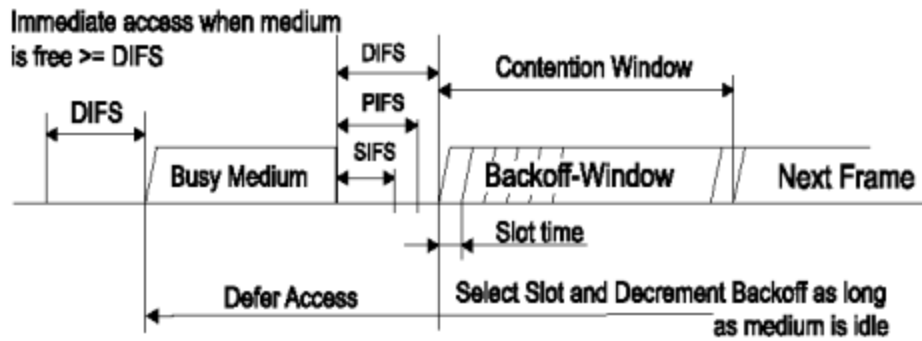

Figure 14: Basic media access method.

6.1 OPNET implementation

We implemented the adaptive back-off mechanism and integrated it into the *wlan_mac* process model (Figure 15). Two states, (PT_TEST and PT_BACKOFF), and one condition (PT_SATISFIED) are inserted into the process model. We have modified states IDLE, DEFER, BACKOFF_NEEDED,

BACKOFF, and TRANSMIT. We also modified the interrupts in the Function Block and added a switch to the Node Attributes Interface for easy switching between the Standard Back-off and Adaptive Back-off modes (Figure 16).

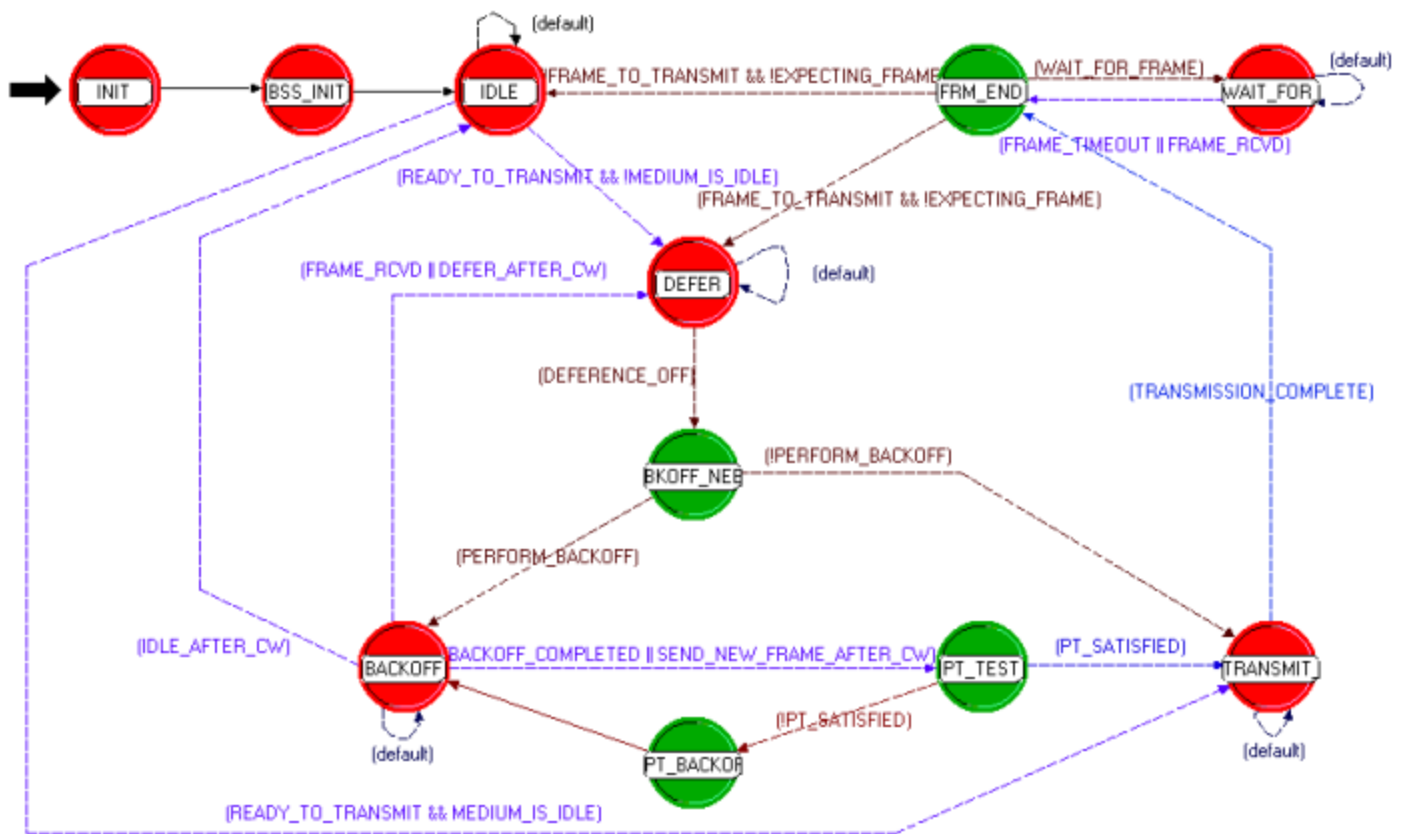

Figure 15: Modified *wlan_mac* process model.

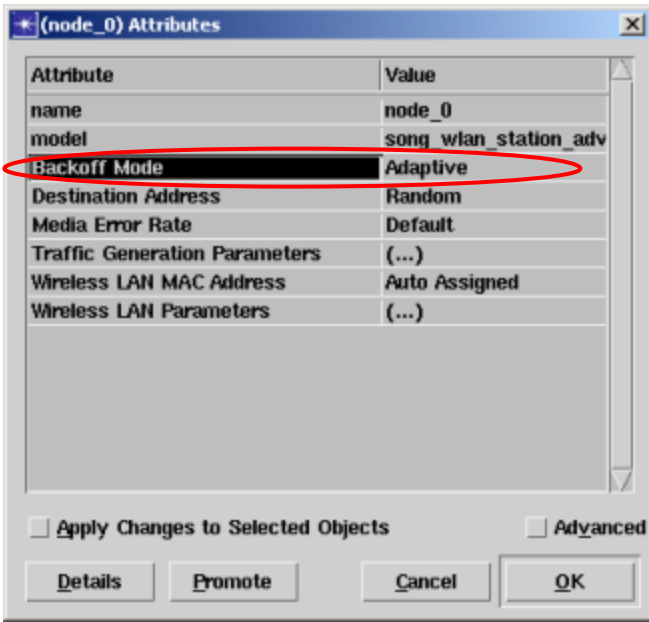

Figure 16: OPNET node attributes interface.

The additional pseudo code for states BACKOFF, PT_BACKOFF, PT_TEST, and BKOFF_NEEDED is:

BACKOFF state: the system monitors the channel and keeps track of *Backoff_Time* and *Channel_Busy_Time* in terms of time slots.

PT_BACKOFF state:

```

if      Current_Contention_Window
        < Min_Contention_Window
then
    Current_Contention_Window
        = Min_Contention_Window
else
    Current_Contention_Window
        = Current_Contention_Window * 2 + 1
if      Current_Contention_Window
        > Max_Contention_Window
then
    Current_Contention_Window
        = Max_Contention_Window

```

Backoff_Time = random_uniform(*Current_Contention_Window*)
go to state BACKOFF

PT_TEST state:

```

Channel_Utilization = Channel_Busy_Time / Backoff_Time
Possibility_to_Transfer = 1 - Channel_Utilization
Transfer_Threshold = random_uniform(0, 1)
if      Possibility_to_Transfer < Transfer_Threshold
then
    go to state PT_BACKOFF
else
    transfer packet

```

BKOFF_NEEDED state:

```

set      Channel_Utilization = 0
set      Channel_Busy_Time = 0
set      Backoff_Times_Counter = 0

```

6.2 Simulation scenarios and settings

We employed three simulation scenarios with various numbers (11, 21, and 65) of identical WLAN stations. An example scenario with 11 stations is given in Figure 17. They send data at an average rate of 820 kbps. Destination stations are randomly chosen by the source station. The traffic attributes are listed in Table 7.

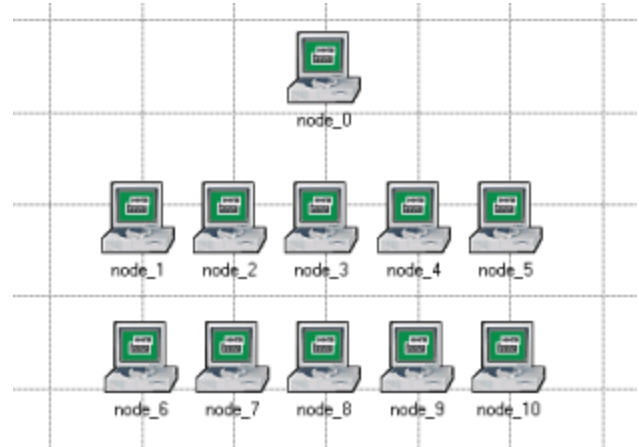

Figure 17: Simulation scenario with 11 stations.

Attribute	Value
Packet sending start time (sec)	constant (2)
Packed sending stop time (sec)	never
Packet interarrival time (sec)	exponential (0.01)
Packet size (bytes)	exponential (1,024)
Segmentation size (bytes)	no segmentation

Table 7: Traffic generation parameters.

6.3 Simulation results

Simulation parameters are listed in Table 8. The *throughput* and *load* of node_0 are collected for analysis. The *throughput* is the bit rate sent to the higher layer [2]. It represents the rate of data successfully received from other stations. WLAN *load* is the bit rate submitted to the WLAN layer by higher layers in the node [2]. It also represents the rate of data sent to other stations.

	Scenario 14	Scenario 15	Scenario 16
Number of stations	11	21	65
Error Mode	None	None	None
Bits Error Rate (1/bits)	N/A	N/A	N/A
Fragmentation Threshold	None	None	None
WLAN bandwidth (bps)	11 M	11 M	11 M
WLAN buffer size (bits)	256 k	256 k	256 k
Max receive lifetime (s)	0.5	0.5	0.5
Short retry limit (slots)	7	7	7
Long retry limit (slots)	4	4	4
PHY characteristic	Frequency hopping	Frequency hopping	Frequency hopping

Table 8: Effect of Adaptive Back-off: parameters for simulation scenarios 14, 15, and 16.

The simulation results (Figures 18-23) illustrate that with the adaptive back-off mechanism, *load* between WLAN stations can be greatly reduced while *throughput* can still maintain the same or achieve a slightly higher value. The reduction of WLAN *load* is important for power reduction in wireless devices. Furthermore, the adaptive back-off mechanism can effectively reduce the number of collisions and data loss in wireless networks.

Simulation results with 11 WLAN stations show that adaptive back-off algorithm can reduce the network load by approximately 20% compared to the standard back-off algorithm (Figure 18). Adaptive back-off algorithm can also achieve a slightly higher throughput (Figure 19).

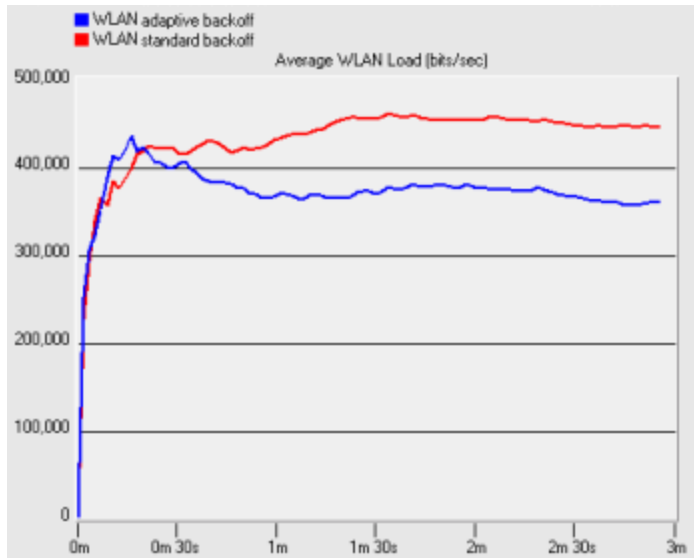

Figure 18: Simulation scenario 14: Adaptive Back-off has a lower load with 11 WLAN stations.

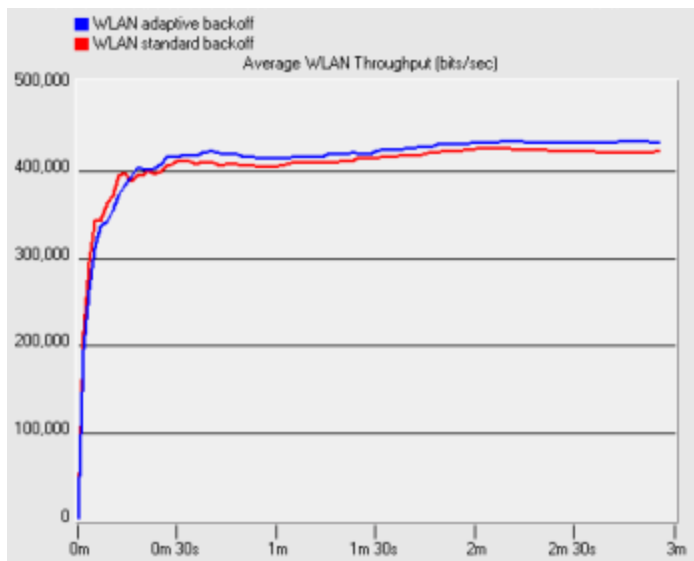

Figure 19: Simulation scenario 14: Adaptive Back-off achieves a slightly higher throughput with 11 WLAN stations.

Simulation results indicate that throughput/load behavior of WLAN with 21 stations is consistent with WLAN with 11 stations. In case of 21 stations, adaptive back-off algorithm reduces the network load by almost 30% (Figure 20), while still maintaining good throughput compared to the standard back-off algorithm (Figure 21).

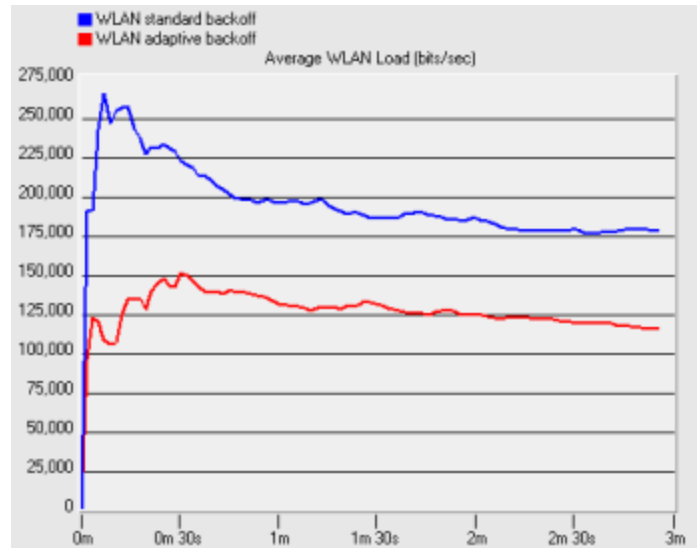

Figure 20: Simulation scenario 15: Adaptive Back-off has a much lower load with 21 WLAN stations.

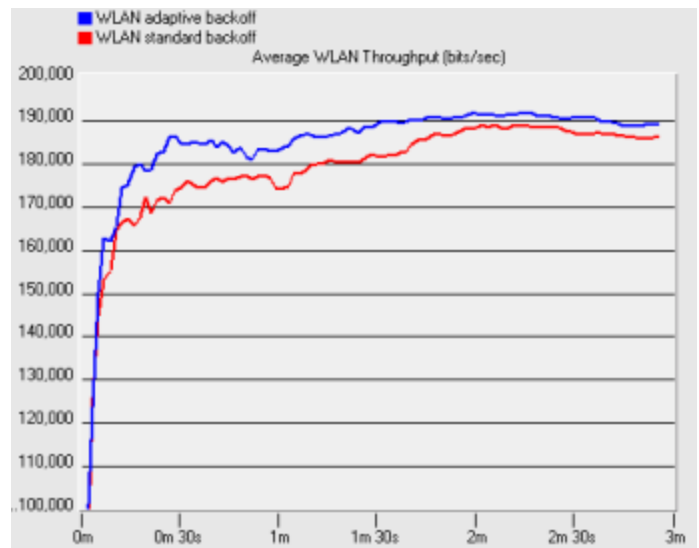

Figure 21: Simulation scenario 15: Adaptive Back-off achieves a slightly higher throughput with 21 WLAN stations.

With 65 WLAN stations, adaptive back-off algorithm can further reduce the network load by over 50% (Figure 22) without deteriorating the network throughput (Figure 23).

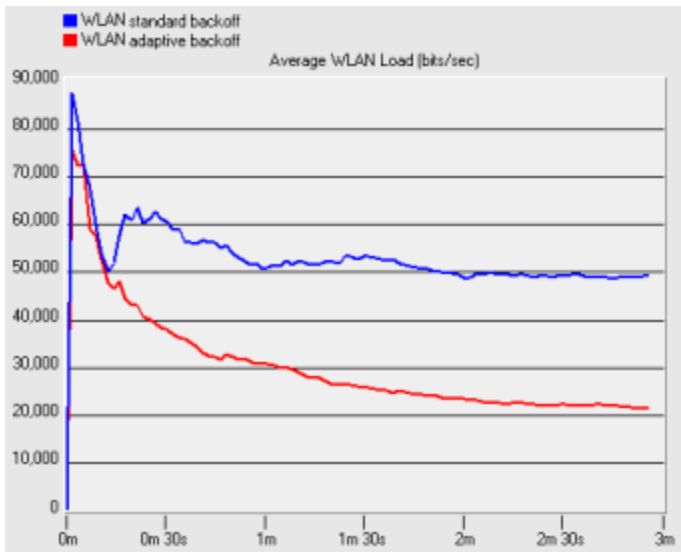

Figure 22: Simulation scenario 16: Adaptive Back-off has a much lower load with 65 WLAN stations.

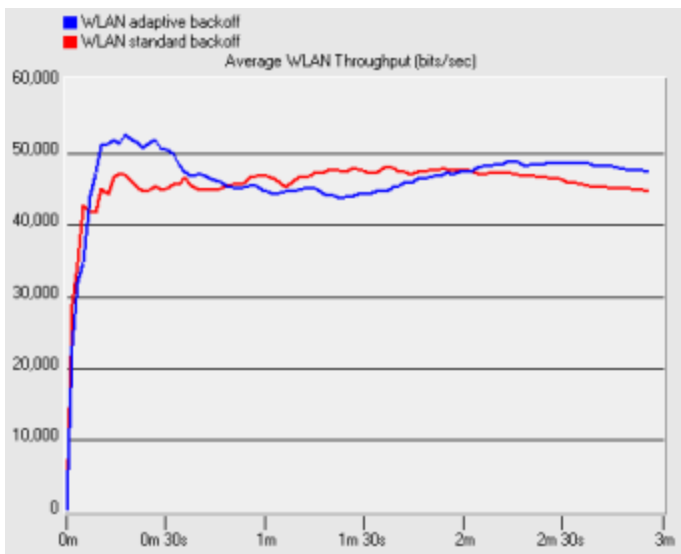

Figure 23: Simulation scenario 16: Adaptive Back-off maintains throughput with 65 WLAN stations.

7. Conclusions

In this paper, we implemented three methods for improving WLAN performance. OPNET simulation results indicate that tuning the physical layer characteristic related parameters, such as Slot Time, SIFS, and Minimum Contention Window, can greatly improve the WLAN performance. Simulation results also indicate that properly chosen WLAN parameters, such as Fragmentation Threshold, can improve the WLAN performance when channel bit error rate is high. Finally, the adaptive back-off algorithm in the MAC layer can effectively reduce the number of collisions in the wireless network. It can also save power for wireless devices without deteriorating the WLAN performance.

8. References

- [1] LAN MAN Standards Committee of the IEEE Computer Society, "Part 11: wireless LAN medium access control (MAC) and physical layer (PHY) specifications," ANSI/IEEE Standard 802.11, 1999 Edition.
- [2] OPNET Technologies, Inc., "Wireless LAN model description," http://www.opnet.com/products/library/WLAN_Model_Guide1.pdf.
- [3] L. Bononi, M. Conti, and L. Donatiello, "Design and performance evaluation of a distributed contention control (DCC) mechanism for IEEE 802.11 wireless local area networks," in *Proceedings of First ACM International Workshop on Wireless Mobile Multimedia*, Oct. 1998, pp. 59-67.
- [4] F. Cali, M. Conti, and E. Gregori, "IEEE 802.11 protocol: design and performance evaluation of an adaptive back-off mechanism," *IEEE Journal on Selected Areas in Communications*, vol. 18, no. 9, Sept. 2000, pp. 1774-1786.
- [5] F. Cali, M. Conti, and E. Gregori, "Dynamic tuning of the IEEE 802.11 protocol to achieve a theoretical throughput limit," *IEEE/ACM Transactions on Networking*, vol. 8, no. 6, Dec. 2000, pp. 785-799.
- [6] S. Keshav and S. Morgan, "SMART retransmission: performance with overload and random losses," in *Proceedings IEEE INFOCOM'97*, Apr. 1997, pp. 1131-1138.
- [7] C.-H. Ng, J. Chow, and Lj. Trajkovic, "Performance evaluation of the TCP over WLAN 802.11 with the Snoopy performance enhancing proxy," *OPNETWORK 2002*, Washington, DC, Aug. 2002.
- [8] C. Parsa and J. J. Garcia-Luna-Aceves, "TULIP: a link-level protocol for improving TCP over wireless links," in *Proceedings IEEE WCNC'99*, New Orleans, Louisiana, Sept. 1999, pp. 1253-1257.
- [9] A. K. Somani and I. Peddibhotla, "Experimental evaluation of throughput performance of IRTCP under noisy channels," in *Proceedings of the Second ACM International Workshop on Wireless Mobile Multimedia*, Aug. 1999, pp. 67-74.
- [10] H. Balakrishnan, V. N. Padmanabhan, S. Seshan, and R. H. Katz, "A comparison of mechanisms for improving TCP performance over wireless links," *IEEE/ACM Transactions on Networking*, vol. 5, no. 6, Dec. 1997, pp. 756-769.
- [11] G. Xylomenos and G. C. Polyzos, "Internet protocol performance over networks with wireless links," *IEEE Network*, vol. 13, no. 4, July-Aug. 1999, pp. 55-63.
- [12] G. Xylomenos and G. C. Polyzos, "TCP and UDP performance over a wireless LAN," in *Proceedings IEEE INFOCOM'99*, New York, NY, Mar. 1999, pp. 439-446.
- [13] E. Ayanoglu, S. Paul, T. LaPorta, K. Sabnani, and R. Gitlin, "Airmail: a link-layer protocol for wireless networks," *ACM Wireless Networks Journal*, vol. 1, no. 1, Feb. 1995, pp. 47-60.