

William Stallings Data and Computer Communications

Chapter 8 Multiplexing

Multiplexing

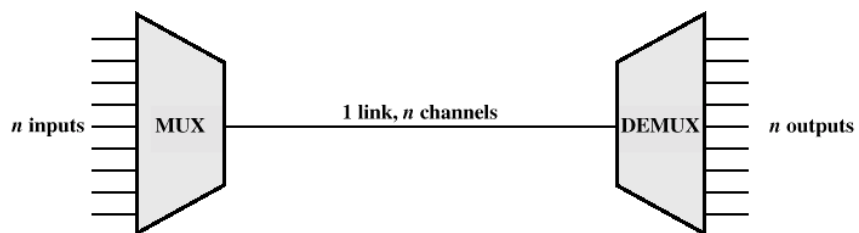

Frequency Division Multiplexing

- FDM
- Useful bandwidth of medium exceeds required bandwidth of channel
- Each signal is modulated to a different carrier frequency
- Carrier frequencies separated so signals do not overlap (guard bands)
- e.g. broadcast radio
- Channel allocated even if no data

Frequency Division Multiplexing Diagram

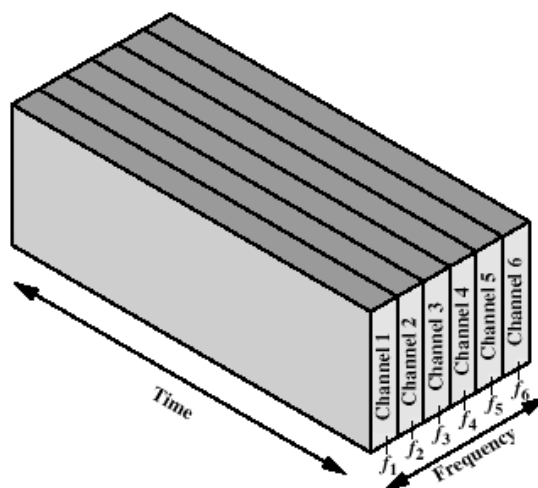

FDM System

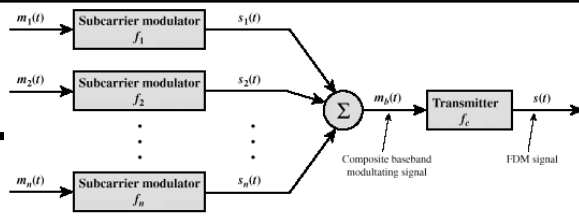

(a) Transmitter

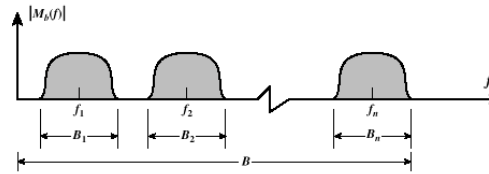

(b) Spectrum of composite baseband modulating signal

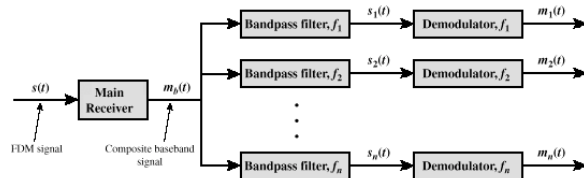

(c) Receiver

FDM of Three Voiceband Signals



(a) Spectrum of $m_1(t)$, positive f

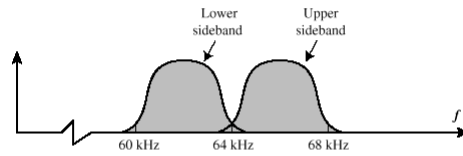

(b) Spectrum of $s_1(t)$ for $f_1 = 64$ kHz

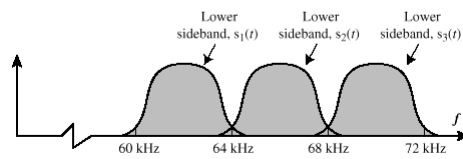

(c) Spectrum of composite signal using subcarriers at 64 kHz, 68 kHz, and 72 kHz

Analog Carrier Systems

- AT&T (USA)
- Hierarchy of FDM schemes
- Group
 - ┆ 12 voice channels (4kHz each) = 48kHz
 - ┆ Range 60kHz to 108kHz
- Supergroup
 - ┆ 60 channel
 - ┆ FDM of 5 group signals on carriers between 420kHz and 612 kHz
- Mastergroup
 - ┆ 10 supergroups

Synchronous Time Division Multiplexing

- Data rate of medium exceeds data rate of digital signal to be transmitted
- Multiple digital signals interleaved in time
- May be at bit level or blocks
- Time slots preassigned to sources and fixed
- Time slots allocated even if no data
- Time slots do not have to be evenly distributed amongst sources

Time Division Multiplexing

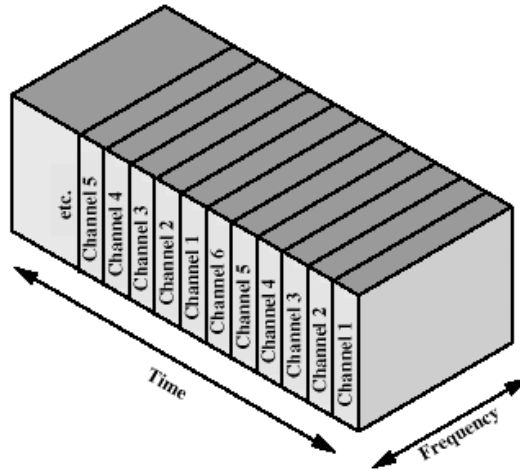

TDM System

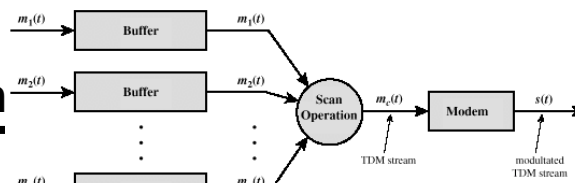

(a) Transmitter

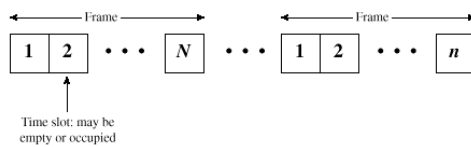

(b) TDM Frames

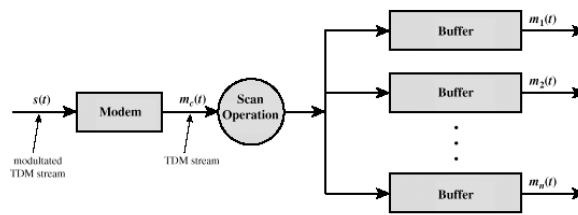

(c) Receiver

TDM Link Control

- No headers and trailers
- Data link control protocols not needed
- Flow control
 - ▮ Data rate of multiplexed line is fixed
 - ▮ If one channel receiver can not receive data, the others must carry on
 - ▮ The corresponding source must be quenched
 - ▮ This leaves empty slots
- Error control
 - ▮ Errors are detected and handled by individual channel systems

Data Link Control on TDM

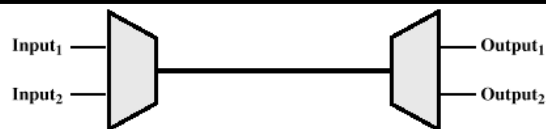

(a) Configuration

Input₁..... F₁ f₁ f₁ d₁ d₁ d₁ C₁ A₁ F₁ f₁ f₁ d₁ d₁ d₁ C₁ A₁ F₁
 Input₂... F₂ f₂ f₂ d₂ d₂ d₂ d₂ C₂ A₂ F₂ f₂ f₂ d₂ d₂ d₂ C₂ A₂ F₂

(b) Input data streams

... f₂ F₁ d₂ f₁ d₂ f₁ d₂ d₁ d₂ d₁ C₂ d₁ A₂ C₁ F₂ A₁ f₂ F₁ f₂ f₁ d₂ f₁ d₂ d₁ d₂ d₁ d₂ d₁ C₂ C₁ A₂ A₁ F₂ F₁

(c) Multiplexed data stream

Legend: F = flag field d = one octet of data field
 A = address field f = one octet of FCS field
 C = control field

Framing

- No flag or SYNC characters bracketing TDM frames
- Must provide synchronizing mechanism
- Added digit framing
 - ┆ One control bit added to each TDM frame
 - ┆ Looks like another channel - "control channel"
 - ┆ Identifiable bit pattern used on control channel
 - ┆ e.g. alternating 01010101...unlikely on a data channel
 - ┆ Can compare incoming bit patterns on each channel with sync pattern

Pulse Stuffing

- Problem - Synchronizing data sources
- Clocks in different sources drifting
- Data rates from different sources not related by simple rational number
- Solution - Pulse Stuffing
 - ┆ Outgoing data rate (excluding framing bits) higher than sum of incoming rates
 - ┆ Stuff extra dummy bits or pulses into each incoming signal until it matches local clock
 - ┆ Stuffed pulses inserted at fixed locations in frame and removed at demultiplexer

TDM of Analog and Digital Sources

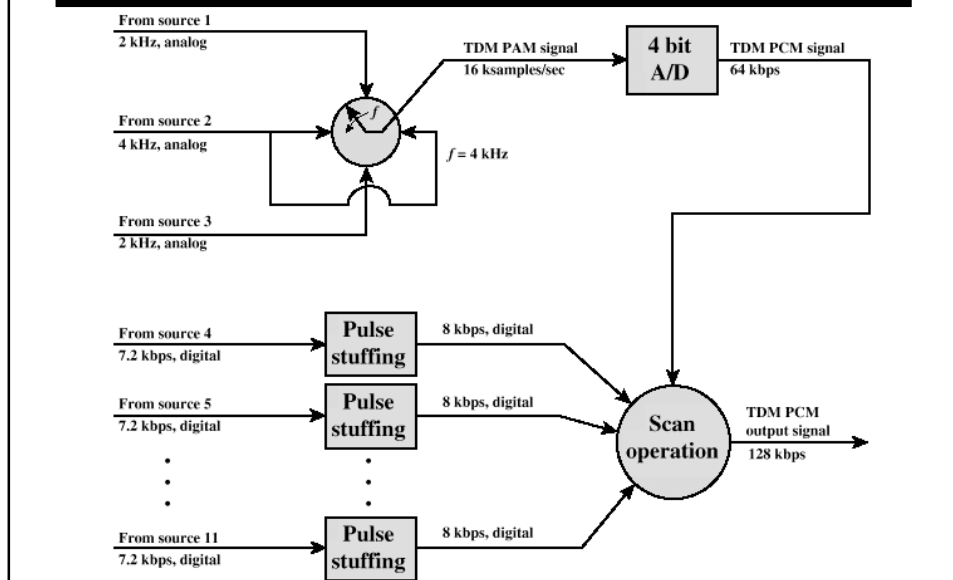

Digital Carrier Systems

- Hierarchy of TDM
- USA/Canada/Japan use one system
- ITU-T use a similar (but different) system
- US system based on DS-1 format
- Multiplexes 24 channels
- Each frame has 8 bits per channel plus one framing bit
- 193 bits per frame

Digital Carrier Systems (2)

- For voice each channel contains one word of digitized data (PCM, 8000 samples per sec)
 - ┆ Data rate $8000 \times 193 = 1.544\text{Mbps}$
 - ┆ Five out of six frames have 8 bit PCM samples
 - ┆ Sixth frame is 7 bit PCM word plus signaling bit
 - ┆ Signaling bits form stream for each channel containing control and routing info
- Same format for digital data
 - ┆ 23 channels of data
 - ┆ 7 bits per frame plus indicator bit for data or systems control
 - ┆ 24th channel is sync

Mixed Data

- DS-1 can carry mixed voice and data signals
- 24 channels used
- No sync byte
- Can also interleave DS-1 channels
 - ┆ Ds-2 is four DS-1 giving 6.312Mbps

ISDN User Network Interface

- ISDN allows multiplexing of devices over single ISDN line
- Two interfaces
 - Basic ISDN Interface
 - Primary ISDN Interface

Basic ISDN Interface (1)

- Digital data exchanged between subscriber and NTE - Full Duplex
- Separate physical line for each direction
- Pseudoternary coding scheme
 - 1=no voltage, 0=positive or negative 750mV +/- 10%
- Data rate 192kbps
- Basic access is two 64kbps B channels and one 16kbps D channel
- This gives 144kbps multiplexed over 192kbps
- Remaining capacity used for framing and sync

Basic ISDN Interface (2)

- B channel is basic user channel
- Data
- PCM voice
- Separate logical 64kbps connections to different destinations
- D channel used for control or data
 - ▮ LAPD frames
- Each frame 48 bits long
- One frame every 250µs

Frame Structure

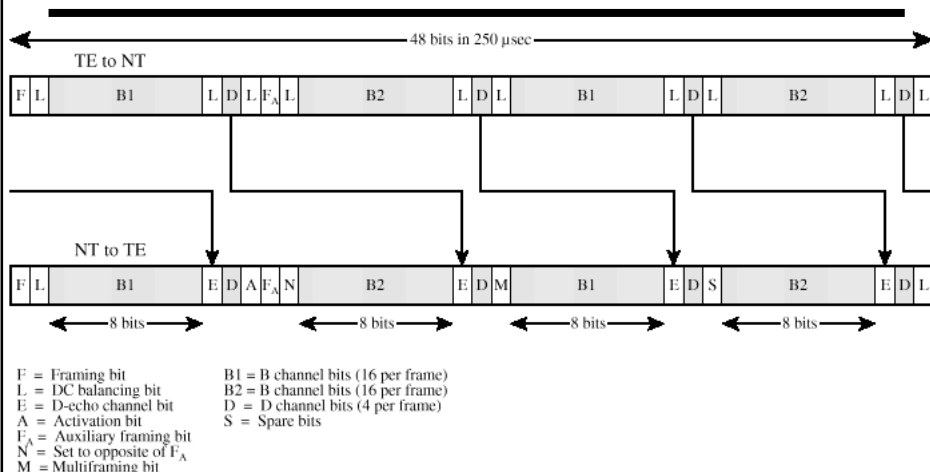

Primary ISDN

- Point to point
- Typically supporting PBX
- 1.544Mbps
 - ┆ Based on US DS-1
 - ┆ Used on T1 services
 - ┆ 23 B plus one D channel
- 2.048Mbps
 - ┆ Based on European standards
 - ┆ 30 B plus one D channel
 - ┆ Line coding is AMI usingHDB3

Primary ISDN Frame Formats

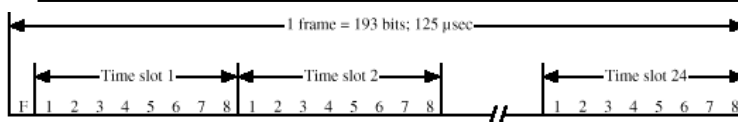

(a) Interface at 1.544 Mbps

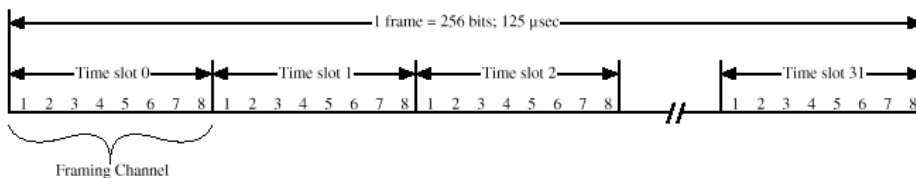

(b) Interface at 2.048 Mbps

Sonet/SDH

- Synchronous Optical Network (ANSI)
- Synchronous Digital Hierarchy (ITU-T)
- Compatible
- Signal Hierarchy
 - Synchronous Transport Signal level 1 (STS-1) or Optical Carrier level 1 (OC-1)
 - 51.84Mbps
 - Carry DS-3 or group of lower rate signals (DS1 DS1C DS2) plus ITU-T rates (e.g. 2.048Mbps)
 - Multiple STS-1 combined into STS-N signal
 - ITU-T lowest rate is 155.52Mbps (STM-1)

SONET Frame Format

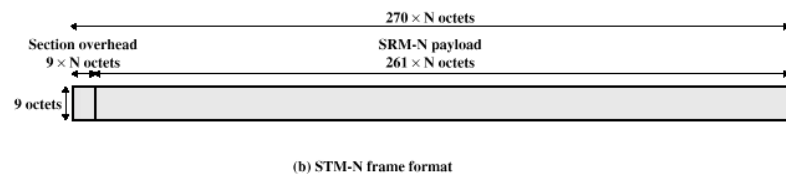
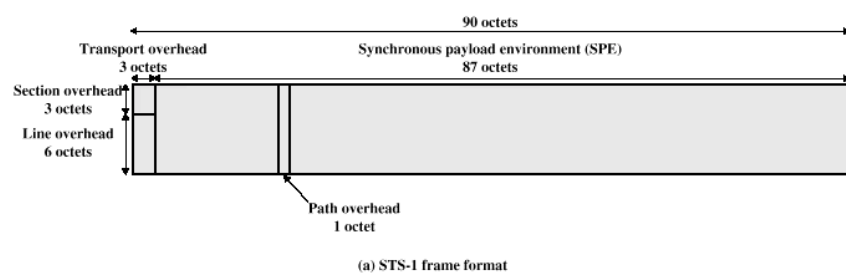

SONET STS-1 Overhead Octets

Section Overhead	Framing A1	Framing A2	STS-ID C1	Trace J1	
	BIP-8 B1	Orderwire E1	User F1		BIP-8 B3
	DataCom D1	DataCom D2	DataCom D3		Signal Label C2
	Pointer H1	Pointer H2	Pointer Action H3		Path Status G1
	BIP-8 B2	APS K1	APS K2		User F2
Line Overhead	DataCom D4	DataCom D5	DataCom D6		Multiframe H4
	DataCom D7	DataCom D8	DataCom D9		Growth Z3
	DataCom D10	DataCom D11	DataCom D12		Growth Z4
	Growth Z1	Growth Z2	Orderwire E2		Growth Z5

(a) Transport Overhead

(b) Path Overhead

Statistical TDM

- In Synchronous TDM many slots are wasted
- Statistical TDM allocates time slots dynamically based on demand
- Multiplexer scans input lines and collects data until frame full
- Data rate on line lower than aggregate rates of input lines

Statistical TDM Frame Formats



(a) Overall frame



(b) Subframe with one source per frame

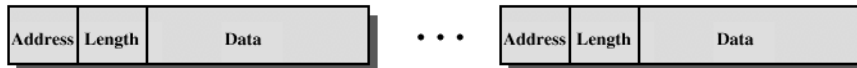

(c) Subframe with multiple sources per frame

Performance

- Output data rate less than aggregate input rates
- May cause problems during peak periods
 - ┆ Buffer inputs
 - ┆ Keep buffer size to minimum to reduce delay

Buffer Size and Delay

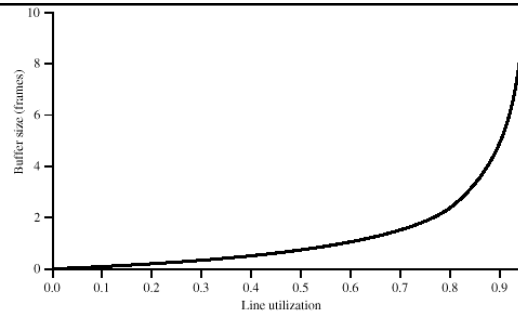

(a) Mean buffer size versus utilization

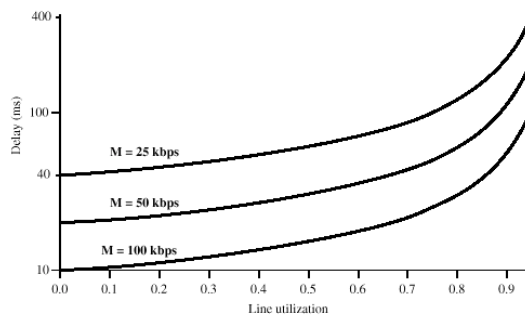

(a) Mean delay versus utilization

Asymmetrical Digital Subscriber Line

- ADSL
- Link between subscriber and network
 - ┆ Local loop
- Uses currently installed twisted pair cable
 - ┆ Can carry broader spectrum
 - ┆ 1 MHz or more

ADSL Design

- Asymmetric
 - ┆ Greater capacity downstream than upstream
- Frequency division multiplexing
 - ┆ Lowest 25kHz for voice
 - ┆ Plain old telephone service (POTS)
 - ┆ Use echo cancellation or FDM to give two bands
 - ┆ Use FDM within bands
- Range 5.5km

ADSL Channel Configuration

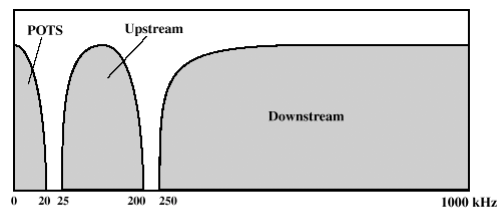

(a) Frequency-division multiplexing

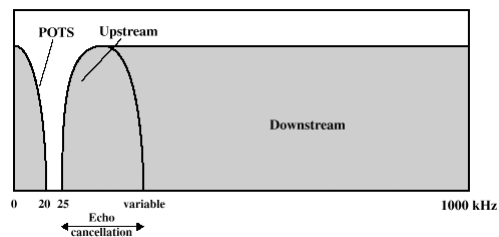

(b) Echo cancellation

Discrete Multitone

- DMT
- Multiple carrier signals at different frequencies
- Some bits on each channel
- 4kHz subchannels
- Send test signal and use subchannels with better signal to noise ratio
- 256 downstream subchannels at 4kHz (60kbps)
 - 15.36MHz
 - Impairments bring this down to 1.5Mbps to 9Mbps

DMT Transmitter

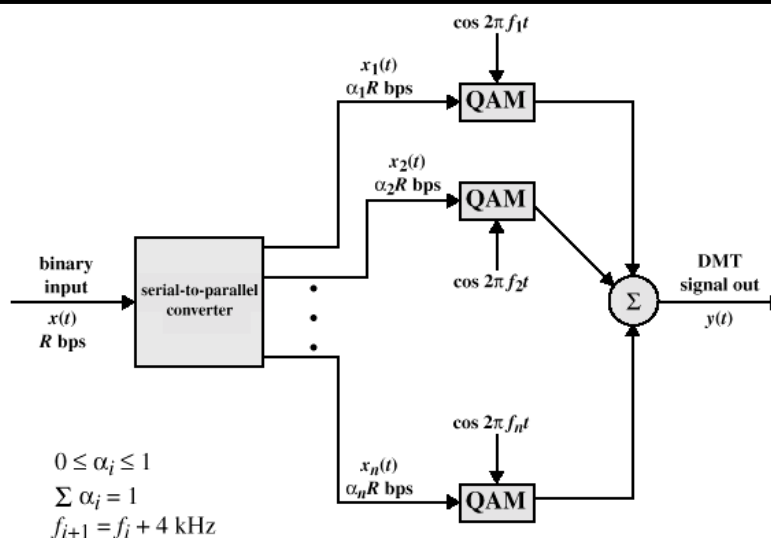

xDSL

- High data rate DSL
- Single line DSL
- Very high data rate DSL

Required Reading

- Stallings chapter 8
- Web sites on
 - ADSL
 - SONET