

Vibrational Spectra, *Ab Initio* Calculations, and Ring-Puckering Potential Energy Function for γ -Crotonolactone

Abdulaziz A. Al-Saadi[†] and Jaan Laane*

Department of Chemistry, Texas A&M University, College Station, Texas 77843-3255

**To whom correspondence should be addressed. E-mail: laane@mail.chem.tamu.edu.*

[†]Present Address: Chemistry Department, King Fahd University of Petroleum and Minerals, Dhahran, 31261, Saudi Arabia (asaadi@kfupm.edu.sa).

ABSTRACT

The infrared and Raman spectra of liquid and vapor γ -crotonolactone have been collected. Both the experimental data and *ab initio* calculations show that the molecule is rigidly planar in its electronic ground state. This conclusion agrees with the previously reported microwave studies and is attributed to the conjugation between the C=C and C=O double bonds of the ring. The ring-puckering potential energy function was generated from *ab initio* calculations and was confirmed by the vapor-phase Raman spectra to be nearly harmonic. DFT calculations predict a harmonic ring-puckering frequency of 203 cm⁻¹ as compared to the observed vapor-phase Raman value of 208 cm⁻¹. The DFT calculations were also used to compute the infrared and Raman spectra of γ -crotonolactone, and these agree very well with the experimental spectra.

Keywords: γ -crotonolactone, *ab initio* calculations, vibrational spectra, ring-puckering potential energy function.

Introduction

γ -Crotonolactone is similar in structure to 2-cyclopenten-1-one which has been investigated in its ground and excited states using several spectroscopic and computational techniques. The infrared and Raman vibrational spectra¹⁻⁴ as well as density functional theory (DFT)⁵ have shown 2-cyclopenten-1-one to be strictly planar in its S_0 electronic ground state and to be governed by a stiff single-minimum ring-puckering potential energy function.^{4,5} This is the result of conjugation involving both the C=C and C=O double bonds.

The studies on the structure of 2-cyclopenten-1-one were carried out for its singlet (S_1) and triplet (T_1 and T_2) electronic excited states.⁶⁻⁹ Cheatham and Laane used fluorescence excitation spectroscopy (FES) to investigate the $S_1(n,\pi^*)$ state and showed that the molecule retains its planar structure in the $S_1(n,\pi^*)$ excited state but becomes much less rigid as compared to the ground state.⁶ DFT calculations agreed very well with the FES results and confirmed the planar conformation of 2-cyclopenten-1-one in its $S_1(n,\pi^*)$ excited state.⁵ The $T_1(n,\pi^*)$ triplet state for 2-cyclopenten-1-one was later studied using cavity ringdown (CRD) absorption spectroscopy⁷ along with several theoretical calculations.^{5,8,9} It was concluded from the CRD that the molecule is slightly puckered in its $T_1(n,\pi^*)$ state with a barrier to planarity of 43 cm^{-1} .⁷ The calculated barrier for the $T_2(\pi,\pi^*)$ triplet state using DFT-B3LYP/6-311+G(d,p) was found to be 999 cm^{-1} .⁵

γ -Crotonolactone differs from 2-cyclopenten-1-one in that it has an oxygen atom instead of a carbon atom across the ring from the C=C double bond. In the case of

2-cyclopenten-1-one, γ -crotonolactone has also been shown from microwave studies^{10,11} to be planar and to possess C_s symmetry in its electronic ground state. The microwave work also suggested¹¹ that the ring-puckering vibration would have an essentially quadratic potential energy function.

As with 2-cyclopenten-1-one, an interesting feature of γ -crotonolactone is the conjugation between the C=C and C=O groups. This feature has been of particular interest in several infrared and Raman studies of some unsaturated monocyclic lactones in various solvents.¹²⁻¹⁴ Considerable attention in these studies was directed to the spectral region just below 1800 cm^{-1} which includes the C=O stretching region. In general, lactones in the liquid phase show two significant peaks related to the C=O stretching motion. The interpretation of this phenomenon was ascribed to the Fermi resonance between the carbonyl stretching vibration and the overtones or combinations of other low-frequency vibrations.¹²⁻¹⁴ Nyquist *et al.* presented a mathematical model for calculating the approximate unperturbed C=O stretching frequency for several cyclic five- and six-membered ring lactones in CCl_4 and CHCl_3 solvents.¹⁴ A different study on the integrated intensities of the carbonyl stretching bands of several unsaturated five-membered cyclic γ -lactones in acetonitrile solutions concluded that the presence of the conjugation between the $-\text{O}-\text{C}=\text{O}$ group and the C=C bond moderately enhances the intensity of the carbonyl stretching band as compared to the no conjugation case.¹⁵ No detailed vibrational assignments or gas-phase vibrational studies, however, have been carried out on γ -crotonolactone. For its excited state structure, the partially overlapping $\pi-\pi^*$ and $n-\pi^*$ transitions in the UV spectra of the liquid have been reported.¹⁶

Experimental

γ -Crotonolactone was obtained from Aldrich with a stated purity of 98%. It is a colorless liquid with a very slightly pinkish color in the commercial sample that disappeared with further purification under vacuum. Its melting point and boiling point are 3°C and 214°C, respectively.

The vapor and liquid Raman spectra of γ -crotonolactone were recorded using a JobinYvon U-1000 double monochromator equipped with a CCD detector and an Innova I-100 argon ion laser operating at 5145 Å. For the vapor-phase Raman studies, the sample was transferred under vacuum into a custom designed, thermally controlled glass Raman cell previously described.^{17,18} The sample was heated to approximately 240°C. The Raman spectra of the liquid γ -crotonolactone were recorded at room temperature for a sample sealed in an evacuated 1mm glass tube. The polarized spectra of the liquid were also recorded to help in the assignments. Laser powers of 0.2 W for the liquid-phase spectra and 4.5 W for the vapor-phase spectra were used.

The infrared spectrum of a drop of γ -crotonolactone liquid between two KBr windows was recorded using a Biorad FTS-60 spectrometer equipped with a globar source, KBr beamsplitter, and a triglycerin sulfate detector. A total of 256 scans at 1.0 cm⁻¹ resolution were averaged. The background spectrum taken under same conditions was subtracted from the γ -crotonolactone spectrum in order to obtain the transmittance spectrum.

Computations

Density functional theory (DFT) with the B3LYP hybrid functional, *ab initio* second-order Moller-Plesset (MP2) and Hartree-Fock (HF) calculations using the Gaussian 03 program¹⁹ were carried out for γ -crotonolactone in its electronic ground state. In this work the coupled-cluster treatment was used to predict the geometry of the most stable structure as well as the structure of 2-cyclopenten-1-one. The DFT-B3LYP with the cc-pVTZ (triple- ζ) basis set was used to calculate the vibrational frequencies, infrared and Raman intensities, and depolarization ratios.

The one-dimensional single-minimum puckering potential function for γ -crotonolactone was calculated point by point by varying the puckering angle from -30° to 30° by increments of 5° with the MP2, DFT-B3LYP, and HF theories using the triple- ζ basis set. The optimized structure from the CCSD/6-311++G(d,p) calculation was used to determine the kinetic energy expansion terms for γ -crotonolactone using a program previously described.²⁰ These kinetic energy terms and the potential function from *ab initio* computations were used to calculate the puckering quantum transitions.

Molecular Structure

The high-level *ab initio* calculations predicted γ -crotonolactone to be planar in its minimum energy structure, in agreement with previous microwave results.^{10,11} Figure 1 shows the calculated C_s planar structure of γ -crotonolactone from the CCSD/6-311++G(d,p) calculation and compares it to the structure of 2-cyclopenten-1-one. It can be seen from Figure 1 for both molecules that as a result of conjugation the C-C single

bond connecting the carbonyl carbon atom to the C=C group is shorter in length than the other C-C single bonds reflecting the conjugation in these molecules. For γ -crotonolactone this is 1.493Å vs. 1.507Å while for 2-cyclopenten-1-one it is 1.491Å vs. values in the 1.518 to 1.544Å range.

Vibrational Spectra

γ -Crotonolactone, as previously discussed, is planar with the ring atoms and the carbonyl oxygen lying in the symmetry plane. Its vibrational spectra are governed by C_s symmetry and result from symmetry species $16A' + 8A''$. Figure 2 shows the Raman spectra (vapor, liquid, and calculated) while Figure 3 presents the liquid and calculated mid-infrared spectra. The agreements between experimental and computed spectra are remarkably good. Based on the vibrational spectra in Figures 2 and 3, the complete assignments of the vibrational modes were made, and these are shown in Table 1. The computed frequencies and depolarization ratios from the DFT calculations are also listed in Table 1 and these agree well with the experimental results. The parallel and perpendicular polarized spectra for γ -crotonolactone can be found elsewhere.²¹ Several combination bands and overtones were also observed in the infrared and Raman spectra of the vapor, but these are not present in the calculated spectra. In several cases there are significant frequency shifts between the liquid and vapor spectra indicating that there are fairly strong intermolecular interactions in the liquid state. In addition, extra bands of some intensity indicate the presence of Fermi resonance.

The ring-puckering vibration was observed in the vapor-phase Raman spectra as a broad band at 208 cm^{-1} with no evident side bands indicating that γ -crotonolactone is rigidly planar with a very nearly harmonic potential function. The broadness of the band arises both from the Raman band type and the fact that a number of closely spaced bands arising from the puckering transitions between different quantum states are expected. This is in contrast to 2-cyclopenten-1-one which has considerable quartic character. The other vibrations of γ -crotonolactone were for the most part assigned with the help of the polarization measurements and the DFT computed frequencies. The C=O stretching vibration can be readily assigned to the most intense peaks in the infrared and Raman spectra. In the liquid-phase experiment these peaks are doublets (1739 and 1773 cm^{-1}) as has been found in previous studies of other unsaturated lactones.¹²⁻¹⁴ In the vapor phase the C=O stretching vibration is only a singlet at higher frequency (1809 cm^{-1}) and is in good agreement with the calculated value of 1822 cm^{-1} . This reflects the fact that the strong intramolecular interactions in the liquid phase are not present in the vapor.

Kinetic and Potential Energy Functions

In order to predict the quantum states associated with the ring-puckering vibration, the potential energy function for this mode was generated by calculating the energy as a function of coordinates using MP2/cc-pVTZ calculations. The CCSD/6-311++G(d,p) level of theory was first used to determine the kinetic energy expansion $g_{44}(x)^{20}$ to the sixth power in terms of the ring-puckering coordinate. This was found to be

$$g_{44}(x) = 0.00473872 - 0.0394847 x^2 + 0.114150 x^4 - 0.198735 x^6. \quad (1)$$

where x is in Angstroms and $g_{44}(x)$ is expressed in reciprocal atomic mass units. Figure 4 shows the definitions for the puckering angle (ϕ) and puckering coordinate (x). The relative energies for γ -crotonolactone obtained from varying ϕ from -30° to 30° in steps of 5° and fixing the four carbon atoms in the plane of the molecule were calculated and are listed elsewhere.²¹ Figure 5 shows the potential functions of the puckering motion in terms of the dihedral angle (ϕ) from different levels of theory. As can be seen from the figure, all four calculations predict a planar structure for the molecule and a stiff potential function, in good correlation with the experimental.

When the MP2/cc-pVTZ results are used to calculate the potential energy, this can be fitted with the function

$$V(\text{cm}^{-1}) = 1.01 \times 10^5 x^2 + 4.59 \times 10^5 x^4. \quad (2)$$

We found the MP2 method with the triple- ζ basis set to provide the best data for the potential function since the results from this level of calculations produce the most reliable structures and energies. The ring-puckering quantum states calculated from this function are shown in Table 2. As is evident, the vibration is almost totally harmonic with a calculated frequency of 181 cm^{-1} , in good agreement with the experimentally observed value of 208 cm^{-1} . It should be noted that although the quartic term in Eq. (2) appears to be significant, it only makes a minor contribution as the value of x only ranges from -0.1 \AA to $+0.1 \text{ \AA}$, while the dihedral angle goes from -30° to $+30^\circ$. Here,

the x^4 contribution for x values in this range is more than one hundred times less than the x^2 contribution. The *ab initio* potential function in terms of the puckering coordinate is shown in Figure 6. The figure also shows the quantum transitions determined from *ab initio* calculations and compares this potential function of γ -crotonolactone with the one previously reported for 2-cyclopenten-1-one.⁴ The greater ring rigidity in γ -crotonolactone as compared to 2-cyclopenten-1-one is evident, and can be explained in terms of the higher angle strain in the case of γ -crotonolactone. Not only is the bending force constant for the C-O-C angle greater than that for a C-C-C angle, but γ -crotonolactone also prefers to have a smaller value for that angle.

Conclusions

γ -Crotonolactone was confirmed to be planar in its ground state from its vibrational spectra and theoretical calculations. Unlike 2-cyclopenten-1-one which has sizeable quartic character for its potential energy function, the ring-puckering vibration in γ -crotonolactone is governed by a much stiffer potential energy function where the quadratic term is predominant. *Ab initio* calculations predict the vibrational spectra and energies for γ -crotonolactone to be in very good agreement with the experiment. Vibrational analyses were carried out using both experimental (infrared, Raman) and calculated spectra, and the agreement was excellent.

Acknowledgments:

The authors wish to thank the National Science Foundation and the Robert A. Welch Foundation for financial support. A. Al-Saadi also wishes to thank King Fahd University of Petroleum and Minerals (KFUPM) for its financial support.

REFERENCES

- (1) Chao, T. H.; Laane, J. J. *Mol. Spectrosc.* **1973**, *48*, 266.
- (2) Chadwick, D.; Legon, A. C.; Millen, D. J. *J. Chem. Soc., Faraday Trans.* 1979, *75*, 302.
- (3) Cataliotti, R.; Paliani, G.; Santini, S. *J. Mol. Spectrosc.* **1984**, *103*, 56.
- (4) Cheatham, C. M.; Laane, J. *J. Chem. Phys.* **1991**, *94*, 5394.
- (5) Choo, J.; Kim, S.; Drucker, S.; Laane, J. *J. Phys. Chem.* **2003**, *107*, 10655.
- (6) Cheatham, C. M.; Laane, J. *J. Chem. Phys.* **1991**, *94*, 7734.
- (7) Pillsbury, N. R.; Choo, J.; Laane, J.; Drucker, S. *J. Phys. Chem.* **2003**, *107*, 10648.
- (8) Garcia-Exposito, E.; Bearpark, M. J.; Ortuno, R. M.; Branchadell, V.; Robb, M. A.; Wilsey, S. *J. Org. Chem.* **2001**, *66*, 8811.
- (9) Sunoj, R. B.; Lakshminarasimhan, P.; Ramamurthy, V.; Chandrasekhar, J. *J. Comput. Chem.* **2001**, *22*, 1598.
- (10) Legon, A. C. *Chem. Commun.* **1970**, 838.
- (11) Alonso, J. L.; Legon, A. C. *J. Chem. Soc., Faraday Trans.* **1981**, *77*, 2191.
- (12) Jones, R. N.; Angell, C. L.; Ito, T.; Smith, R. J. D. *Can. J. Chem.* **1959**, *37*, 2007.
- (13) Bond, R. P. M.; Chairns, T.; Connolly, J. D.; Eglinton, G.; Overton, K. H. *J. Chem. Soc.* **1965**, 3958.
- (14) Nyquist, R. A.; Fouchea, H. A.; Hoffman, G. A.; Hasha, D. L. *Appl. Spectrosc.* **1991**, *45*, 860.
- (15) Wood, A. B.; Buckingham, B.; *Spectrochim. Acta* **1970**, *26A*, 465.
- (16) Brunn, V. J.; Peters, F.; Dethloff, M.; *J. Prakt. Chemie.* **1976**, *318*, 745.
- (17) Haller, K.; Chiang, W.-Y.; del Rosario, A.; Laane, J. *J. Mol. Struct.* **1996**, *379*, 19.
- (18) Laane, J.; Haller, K.; Sakurai, S.; Morris, K.; Autrey, D.; Arp, Z.; Chiang, W.-Y.; Combs, A.; *J. Mol. Struct.* **2003**, *650*, 57.
- (19) Frisch, M. J.; Trucks, G. W.; Schlegel, H. B.; Scuseria, G. E.; Robb, M. A.; Cheeseman, J. R.; Montgomery, Jr., J. A.; Vreven, T.; Kudin, K. N.; Burant, J. C.; Millam, J. M.; Iyengar, S. S.; Tomasi, J.; Barone, V.; Mennucci, B.; Cossi, M.; Scalmani, G.; Rega, N.; Petersson, G. A.; Nakatsuji, H.; Hada, M.; Ehara, M.; Toyota, K.; Fukuda, R.; Hasegawa, J.; Ishida, M.; Nakajima, T.; Honda, Y.; Kitao, O.; Nakai, H.; Klene, M.; Li, X.; Knox, J. E.; Hratchian, H. P.; Cross, J. B.; Bakken, V.; Adamo, C.; Jaramillo, J.; Gomperts, R.; Stratmann, R. E.; Yazyev, O.; Austin, A. J.; Cammi, R.; Pomelli, C.; Ochterski, J. W.; Ayala, P. Y.; Morokuma, K.; Voth, G. A.; Salvador, P.; Dannenberg, J. J.; Zakrzewski, V. G.; Dapprich, S.; Daniels, A. D.; Strain, M. C.; Farkas, O.; Malick, D. K.; Rabuck, A. D.; Raghavachari, K.; Foresman, J. B.; Ortiz, J. V.; Cui, Q.; Baboul, A. G.; Clifford, S.; Cioslowski, J.; Stefanov, B. B.; Liu, G.; Liashenko, A.; Piskorz, P.; Komaromi, I.; Martin, R. L.; Fox, D. J.; Keith, T.; Al-Laham, M. A.; Peng, C. Y.; Nanayakkara, A.; Challacombe, M.; Gill, P. M. W.; Johnson, B.; Chen, W.; Wong, M. W.; Gonzalez, C.; and Pople, J. A.; Gaussian 03, Revision C.02, Gaussian, Inc.: Wallingford CT, 2004.

- (20) Schmude, Jr., R. W.; Harthcock, M. A.; Kelly, M. B.; Laane, J.; *J. Mol. Spectrosc.* **1987**, *124*, 369.
- (21) A. A. Al-Saadi, Ph. D. Thesis, Texas A&M University, 2006.

Table 1. Vibrational assignments for γ -crotonolactone.

		Experimental				Calculated ^a		
		Vapor	Liquid		B3LYP/cc-pVTZ			
Description		Raman	IR ^b	Raman	ρ^c	Scaled	Intensities ^d	ρ^c
A'	ν_1	3123 (47)	~3113 m	3116	0.2	3123	(1,286)	0.18
	ν_2	3097 (80)	3098 ms	3100	0.2	3086	(5,247)	0.36
	ν_3	2885 (233)	2868 m	2872	0.2	2907	(50,577)	0.11
	ν_4	1809 (100)	1739/1773 vs	1737/1772	0.4/0.2	1822	(1000,100)	0.42
	ν_5	1609 (77)	1599 ms	1600	0.1	1636	(18,72)	0.10
	ν_6	1462 (46)	1447 ms	1448	0.5	1469	(16,67)	0.46
	ν_7	1358 (5)	1347 ms	1349	0.6	1349	(15,13)	0.72
	ν_8	1328 (8)	1333 ms	1334	0.1	1337	(22,8)	0.19
	ν_9	1140 (19)	1158 s	1159	0.3	1132	(135,32)	0.42
	ν_{10}	1095 (25)	1094 s	1094	0.5	1095	(162,16)	0.59
	ν_{11}	1043 (37)	1034 s	1032	0.1	1040	(118,14)	0.20
	ν_{12}	939 (40)	940 m	941	0.2	934	(1,15)	0.21
	ν_{13}	865 (45)	881 ms	883	0.1	860	(93,12)	0.11
	ν_{14}	804 (9)	786 m	787	0.8	782	(5,6)	0.74
	ν_{15}	683 (55)	692 ms	693	0.2	686	(7,15)	0.25
	ν_{16}	490 (8)	497 m	498	0.4	488	(5,2)	0.74

Table 1. Continued.

	Description	Experimental				Calculated ^a			
		Vapor	Liquid		B3LYP/cc-pVTZ				
		Raman	IR ^b	Raman	ρ^c	Scaled	Intensities ^d	ρ^c	
<i>A''</i>	ν_{17}	CH ₂ antisym. str.	2947 (134)	~2961 w	2963	0.7?	2933	(25,299)	0.75
	ν_{18}	CH ₂ twist	1153 (8)	~1187 m	1189	0.8	1189	(0,14)	0.75
	ν_{19}	CH ₂ rock	998 (1)	1008 m	1006	0.8	1017	(14,5)	0.75
	ν_{20}	CH out-of-plane bend	973 (4)	977 vw	----		963	(11,0)	0.75
	ν_{21}	C=O out-of-plane bend	830 (4)	810 s	813	0.8	814	(91,5)	0.75
	ν_{22}	CH out-of-plane bend	663 (5)	673 m	677	0.8?	666	(14,4)	0.75
	ν_{23}	C=C twist	~366 (0)	----	362	0.8	356	(13,2)	0.75
	ν_{24}	Ring puckering	208 (1)	----	226	0.8	206	(1,2)	0.75

^aScaled with scaling factors of 0.961 and 0.985 for $\nu > 2000 \text{ cm}^{-1}$ and $\nu < 2000 \text{ cm}^{-1}$, respectively.

^bIR intensities: v=very, s=strong, m=medium, w=weak.

^cDepolarization ratio.

^dInfrared and Raman intensities, respectively.

Table 2. Ring-puckering vibrational levels for γ -crotonolactone as determined from *ab initio* results.

Levels	Frequency (cm ⁻¹)	Relative intensity
0-1	180.6	1.0
1-2	181.6	0.8
2-3	182.7	0.5
3-4	183.7	0.3
4-5	184.7	0.2
5-6	185.7	0.07
6-7	186.7	0.04
7-8	187.7	0.02

FIGURE CAPTIONS:

Figure. 1. Ground-state structures of γ -crotonolactone and 2-cyclopenten-1-one from the CCSD/6-311++G(d,p) calculations.

Figure 2. Vapor-phase, liquid-phase, and calculated Raman spectra for γ -crotonolactone.

Figure 3. Liquid-phase and calculated infrared spectra of γ -crotonolactone.

Figure 4. Definitions of the puckering coordinate (x) and puckering angle (ϕ) for γ -crotonolactone.

Figure 5. Ring-puckering potential energy function from different levels of calculations.

Figure 6. Potential energy function for the ring-puckering vibration as determined from *ab initio* calculations using the MP2/cc-pVTZ level of theory. The ring-puckering potential function for 2-cyclopenten-1-one is shown with dotted lines.

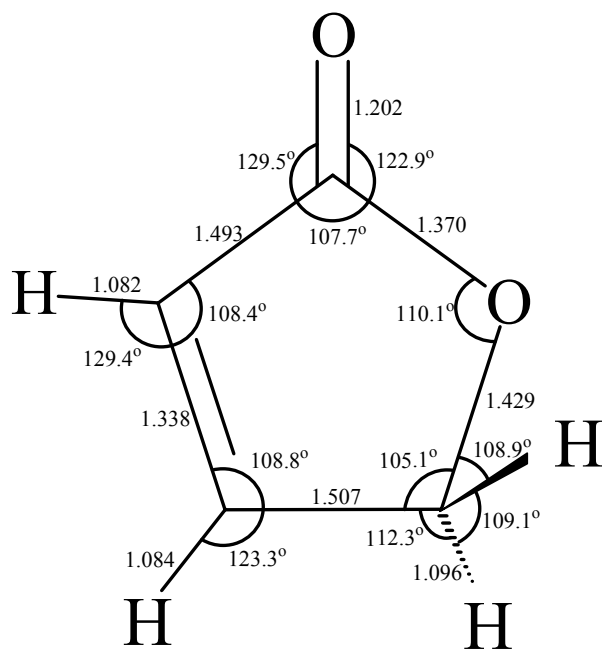

γ -Crotonolactone

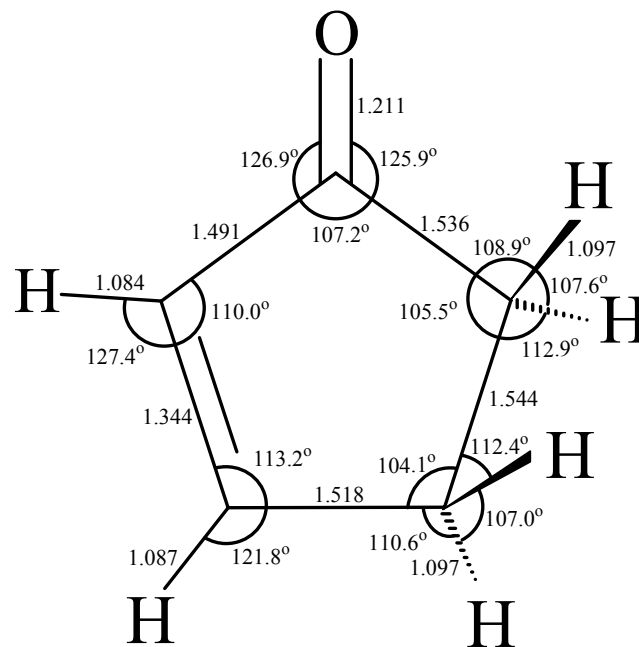

2-Cyclopenten-1-one

Figure 1

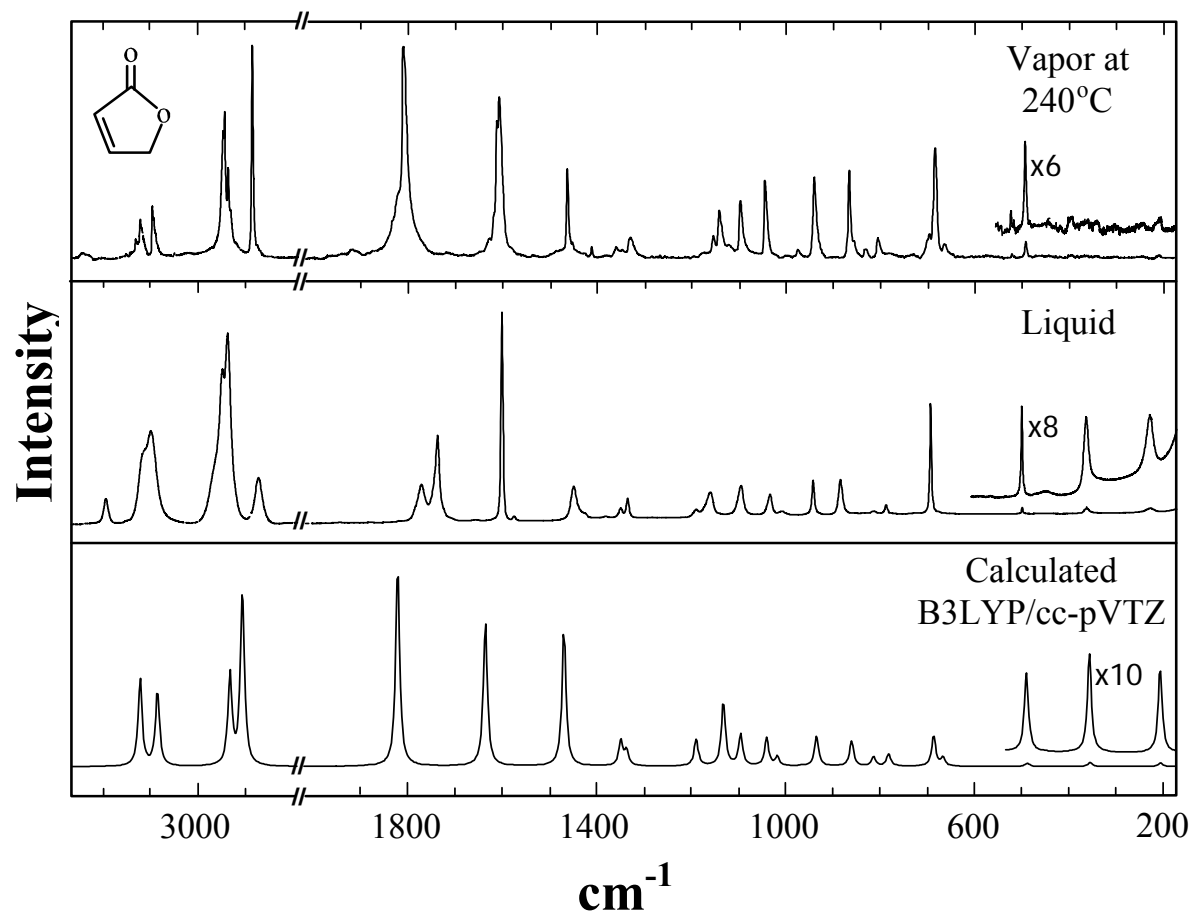

Figure 2

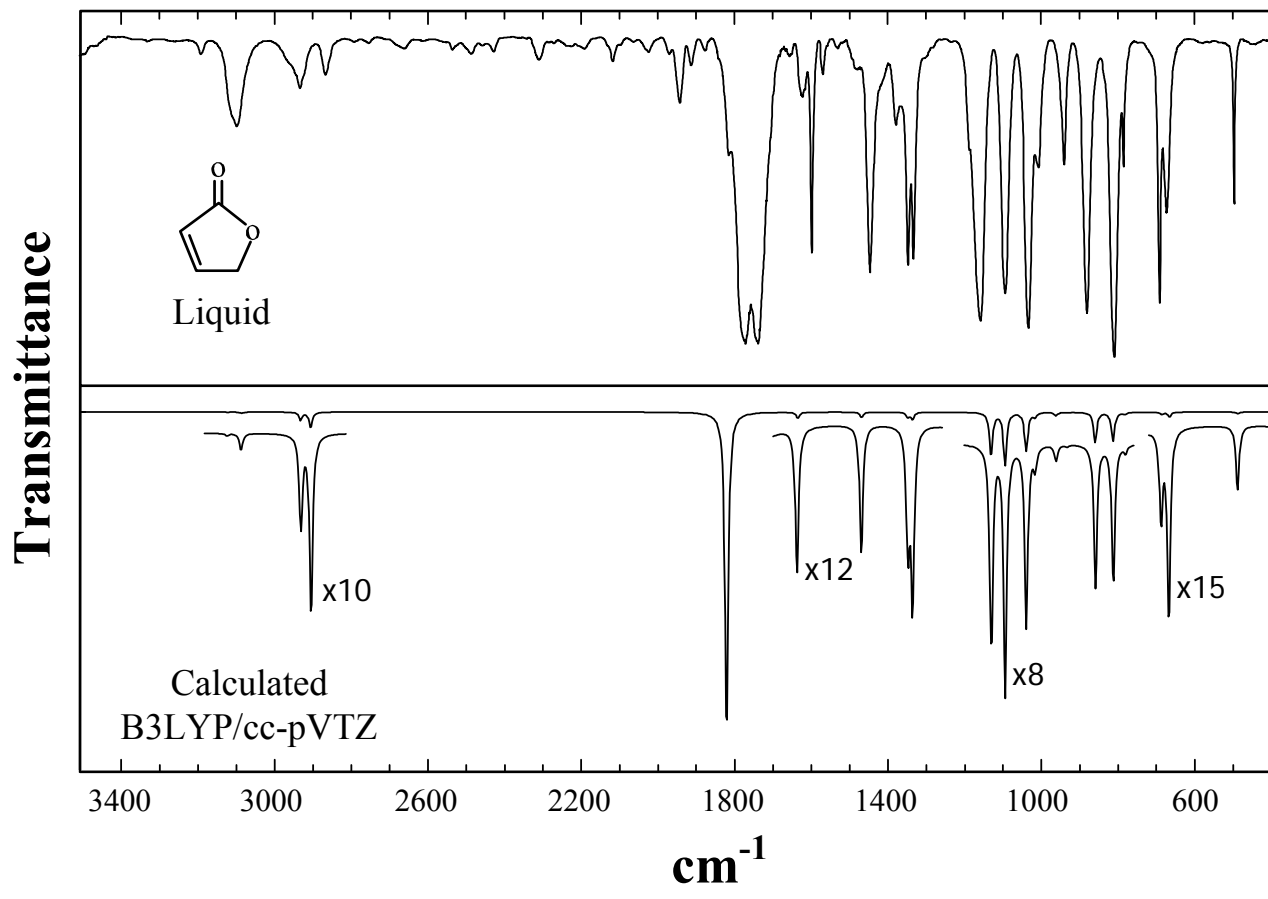
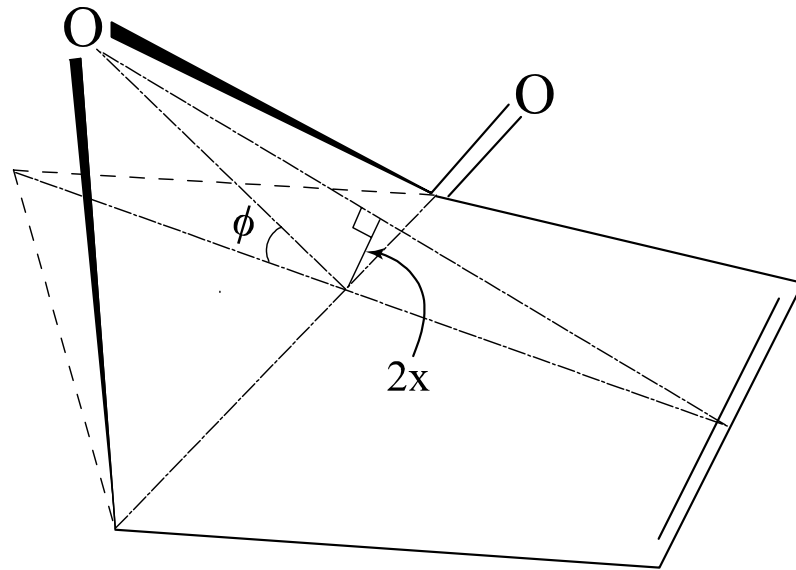

Figure 3



----- Planar structure

Figure 4

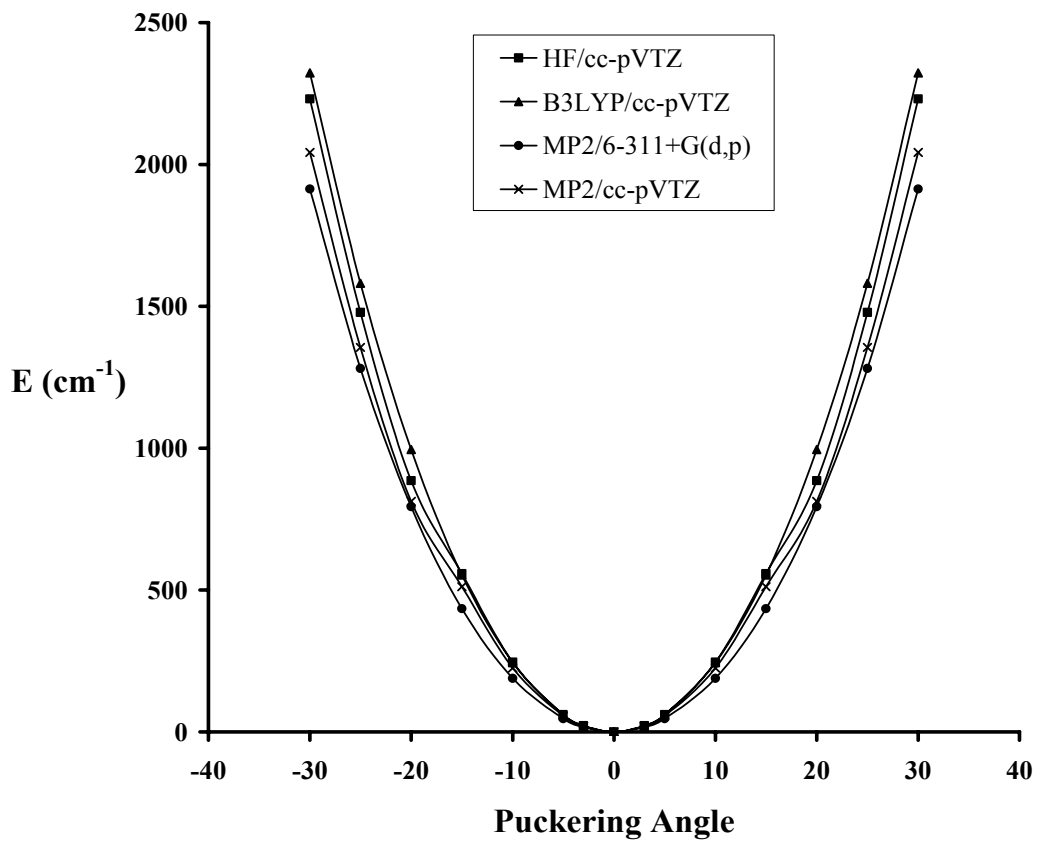

Figure 5

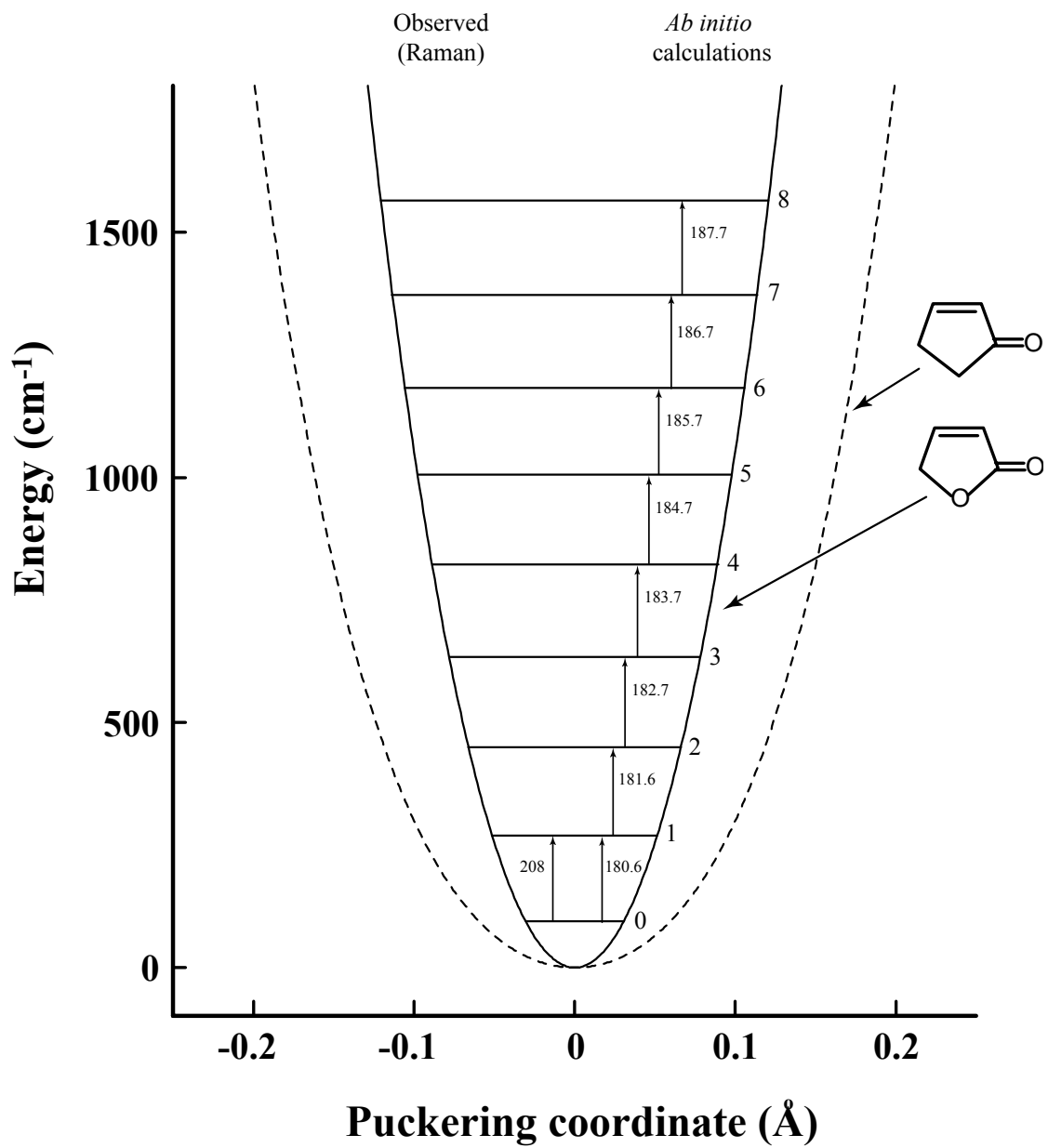

Figure 6