

Plantwide Control for TAME Production Using Reactive Distillation

Muhammad A. Al-Arfaj

Dept. of Chemical Engineering, King Fahd University of Petroleum and Minerals, Dhahran 31261, Saudi Arabia

William L. Luyben

Dept. of Chemical Engineering, Lehigh University, Bethlehem, PA 18015

DOI 10.1002/aic.10138

Published online June 9, 2004 in Wiley InterScience (www.interscience.wiley.com).

The synthesis and control of a plantwide flowsheet to produce tert-amyl methyl ether (TAME) is reported. The flowsheet consists of a plug-flow reactor, one reactive distillation column, and two conventional distillation columns. The two conventional columns are needed for the recovery of excess methanol and the inert C5s. The columns are operated at different pressures to overcome separation limitations resulting from the presence of azeotropes. The reactive distillation is run with an excess of methanol because it is needed for both the reaction and the azeotropic vapor liquid equilibrium (VLE) requirements in the column. The reactive distillation column is the critical unit in this flowsheet that needs to be carefully controlled. An effective control structure is one in which a temperature in the stripping section and a methanol composition in the reactive zone are controlled. This control scheme is similar to that applied to other reactive distillation systems of the same type (that is, ETBE, MTBE). Because there is no reaction in the other two columns, they are effectively controlled by simple temperature controllers. The fresh feed of methanol must be manipulated to maintain the overall balance of methanol in the flowsheet. The proposed control structure is able to handle disturbances in feed rate and composition up to $\pm 20\%$. © 2004 American Institute of Chemical Engineers AICHE J, 50: 1462–1473, 2004
Keywords: reactive distillation, process design and control, tert-amyl methyl ether (TAME)

Introduction

There is an increasing interest in reactive distillation in the chemical and petroleum industries. This interest intensified after the publication of successful implementations of this technique in industry (Agreda et al., 1990). The main applications of reactive distillation in industry are etherification and esterification.

The control of reactive distillation is different from conventional distillation, although it is not unique. The literature with

respect to the control of reactive distillation is not as abundant as in other areas such as analysis of the steady state. In our recent publication (Al-Arfaj and Luyben, 2000) we reviewed some of the literature in this area. We studied the control of different classes of reactive distillation in previously reported studies:

- (1) Two reactants and two products
 - (a) Ideal (Al-Arfaj and Luyben, 2000; Luyben, 2000)
 - (b) Methyl acetate (Al-Arfaj and Luyben, 2002d)
- (2) Two reactants, one product and inert ETBE (Al-Arfaj and Luyben, 2002a)
- (3) One reactant and two products
Olefin metathesis (Al-Arfaj and Luyben, 2002c)
- (4) Multiple reactions

Correspondence concerning this article should be addressed to W. L. Luyben at WLL0@lehigh.edu.

Table 1. Reaction Kinetics and Heats of Reaction

Reaction	A_{f1} ($\text{kmol s}^{-1} \text{kg}^{-1}$)	E_{f1} (kJ/mol)	A_{b1} ($\text{kmol s}^{-1} \text{kg}^{-1}$)	E_{b1} (kJ/mol)	ΔH_{rxn} (kJ/mol)
Rxn 1	1.3263×10^8	76.1037	2.3535×10^{11}	110.5409	-34.44
Rxn 2	1.3718×10^{11}	98.2302	1.5414×10^{14}	124.9940	-26.76
Rxn 3	2.7187×10^{10}	96.5226	4.2933×10^{10}	104.1960	-7.67

Ethylene glycol (Al-Arfaj and Luyben, 2002b)

In those studies we proposed effective structures for these different systems.

The objective of this study is to examine the control of another reactive distillation system [*tert*-amyl methyl ether (TAME)]. The study explores the control of a reactive distillation column in a plantwide environment.

TAME is an oxygenate that is used in gasoline blending as a replacement for lead. The interest in TAME increased after recent bans on the use of methyl tertiary butyl ether (MTBE) because of environmental concerns. Herein we use the design that Subawalla and Fair (1999) proposed and extend their design to add a recovery section that consists of two columns and two recycles. The TAME reactive distillation is an etherification process that is similar to that for ethyl tertiary butyl ether (ETBE). In both systems there are two reactants, one heavy product, and light inerts. It is of interest to find out if a control scheme that provides effective control for the previously studied ETBE case will also work in the TAME reactive distillation process. Aspen Plus and Aspen Dynamics were used for the simulations.

Steady-State Design and Synthesis

Reaction kinetics

TAME is produced by reacting isoamylenes [2-methyl-1-butene (2M1B) and 2-methyl-2-butene (2M2B)] with methanol. The three main reactions that take place, and used in this study, are the following:

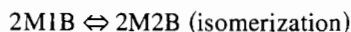
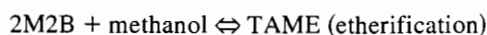
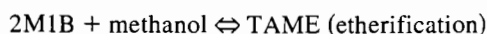

When a stoichiometric mixture of isoamylenes and methanol is used, the conversion at 60°C is limited by chemical equilibrium to 56%. However, conversion increases when excess methanol is used (Subawalla and Fair, 1999).

Krause and coworkers (Rihko and Krause, 1995; Rihko et al., 1997) developed a rigorous heterogeneous kinetic model for the three reactions involved in the TAME production. A simple power-law kinetic model was obtained from the same research group (Kiviranta-Paakkomen, 2001). The reactions kinetics using that simple power-law model are

$$R_1 = A_{f1}e^{-E_{f1}/RT}x_{2\text{M1B}}x_{\text{MeOH}} - A_{b1}e^{-E_{b1}/RT}x_{\text{TAME}}$$

$$R_2 = A_{f2}e^{-E_{f2}/RT}x_{2\text{M2B}}x_{\text{MeOH}} - A_{b2}e^{-E_{b2}/RT}x_{\text{TAME}}$$

$$R_3 = A_{f3}e^{-E_{f3}/RT}x_{2\text{M1B}} - A_{b3}e^{-E_{b3}/RT}x_{2\text{M2B}}$$

where A_f and A_b are the forward and backward preexponential factors ($\text{kmol s}^{-1} \text{kg}^{-1}$); E_f and E_b are the forward and backward activation energies (kJ/mol); x is the component liquid mole fraction; T is the temperature (K); and R is the ideal gas constant ($\text{J mol}^{-1} \text{K}^{-1}$).

The kinetic parameters for the three reactions are given in Table 1. From the activation energies, we can calculate the heat of reaction for the three reactions, which are detailed in the same table (in kJ/mol). The reactions are not highly exothermic. The UNIFAC model was used for vapor liquid equilibrium (VLE) activity coefficient calculation.

Recovery system synthesis

In our work, we use the design proposed by Subawalla and Fair (1999) to produce TAME using a prereactor and a reactive distillation. The mixed C5 feed to the prereactor consists of 2M1B, 2M2B, *n*-pentane, *i*-pentane, 1-pentene, and 2-pentene (*cis*) and is typically obtained from a catalytic cracking unit. The bottoms product from the reactive column is high-purity TAME. Because of the existence of azeotropes between methanol and all the C5 components, the distillate product is about 30 mol % methanol and 70 mol % inert C5s. As stated before, the kinetics require a high methanol-to-isoamylenes ratio to achieve high conversion. The distillate of the reactive column is typically around the methanol/C5s azeotropes. In a practical and complete flowsheet to produce TAME using reactive distillation, the excess methanol must be recovered and recycled back to the system so that only pure TAME and inerts are the products. Therefore, a recovery system must be designed.

To design the recovery system, whose feedstream is typi-

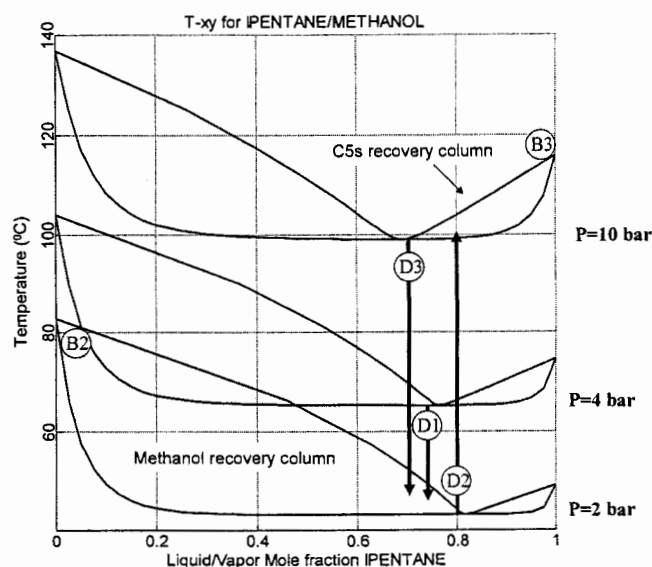

Figure 1. T-xy diagram for distillation synthesis.

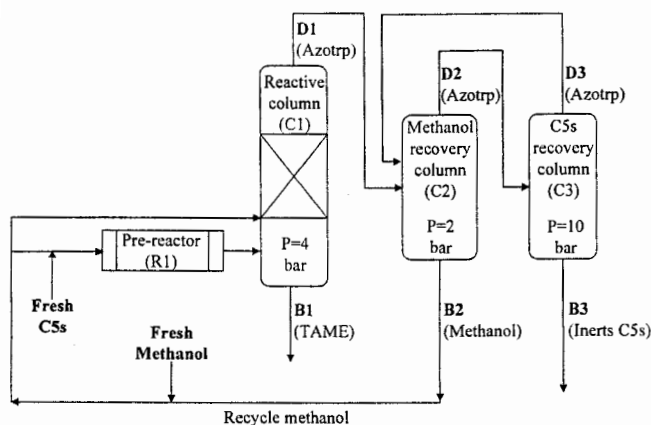

Figure 2. Flowsheet sketch.

cally around the azeotropic mixture of methanol and C5s, we have to examine these azeotropes in depth. The dominant component in the C5 mixture (isopentane) is selected with methanol to see the effect of pressure on the azeotrope. Figure 1 shows the T - xy diagram for i -pentane/methanol at three pressures: 2, 4, and 10 bar. The methanol composition of the azeotrope decreases as the pressure decreases. The objective of the recovery system is to separate the methanol/C5 azeotrope into two fairly pure streams (methanol and C5s). From Figure 1, it is clear that this cannot be done in one column. Two columns operating at different pressures can be used. Figure 2 sketches one possible flowsheet of this process.

Subawalla designed the reactive distillation to operate at 4 bar. Based on Figure 1, the distillate $D1$ of the reactive column can be sent to a methanol recovery column running at lower pressure. The pressure of that column is set such that cooling water can be used (that is, the temperature of the distillate is around 45°C). As shown in Figure 1, if the pressure of the methanol recovery column is set to be 2 bar, the methanol will be recovered in the bottoms $B2$, and the distillate $D2$ will have a composition that is close to the methanol/C5s azeotrope at 45°C . The distillate $D2$ is then sent to a high pressure C5s recovery column to obtain the C5s as bottoms product $B3$. The distillate $D3$ composition will be close to the high-pressure azeotrope, and this stream is recycled back to the methanol recovery column. The pressure of the C5s recovery column could be 4 bar or higher. It is favorable to increase the pressure in the C5s recovery column for two reasons. The higher the pressure, the further away the feed is from the azeotrope. This

ensures that the column will be operated in the desired region even during dynamic disturbances and will not switch to the other region where it will be impossible to obtain pure inert as a product. The second reason is energy consumption. The further away the feed is from the azeotrope, the less distillate $D3$ is recycled, which saves energy. For these reasons a pressure of 10 bar was selected as a reasonable compromise between energy consumption and higher column base temperature (10 bar gives a 110°C base temperature).

Design of recovery columns

We did not try to rigorously optimize the pressure selection nor the design details of the two columns in the recovery system because that was not our objective. The bottoms flow rate for both columns is set based on the overall mass balance, as discussed later. Because the separation is an easy one, the purity specifications are set quite high. The specifications for the methanol recovery column are less than one part per million (ppm) of C5s at the bottoms and a bottoms flow rate of 273 kmol/h. The specifications for the C5s recovery column are a bottoms methanol impurity of less than 20 ppm and a bottoms flow rate of 805.6 kmol/h.

Because the separations between the two products (methanol and C5s) and the azeotropes are very easy, small columns with small reflux ratios are required. Each of the recovery columns has eight trays, a partial reboiler, and a total condenser. The methanol recovery column requires a reflux ratio of 0.5 to achieve the desired separation, whereas the C5s recovery column requires a reflux ratio of one. The feed tray location in both columns is in the middle. Feed-tray location is another design variable that could be optimized. However, the economic impact of the feed location on these small columns with low reflux ratio is minimal.

The bottoms flow rates of both recovery columns are set by the overall mass balance. When the overall isoamylenes conversion is set, we can calculate the bottoms flow rate of the C5s recovery column (which will be equal to the inerts plus unreacted isoamylenes). The total amount of methanol fed to the reactive column could be approximated by adding the amount of methanol consumed in reactions and the amount necessary to remove the C5 components as azeotropes (assuming that the distillate leaves as azeotropic mixture). Because there will be a negligible amount of methanol leaving the system in the bottoms of the C5s recovery column, the bottoms flow rate of the methanol recovery column is equal to the amount of methanol required by the azeotropes of $D1$.

Table 2. Methanol Consumption

	MeOH in Aztrp	Base (kmol/h)		+ Δz (kmol/h)		- Δz (kmol/h)	
		Feed	Az Req.	Feed	Az Req.	Feed	Az Req.
2M1B	24.6%	85.6	0.98	102.72	1.18	68.48	0.78
2M2B	30.2%	164.8	7.37	197.76	8.84	131.84	5.89
2-Pentene	29.2%	161.7	66.69	151.44	62.46	171.96	70.92
i -Pentane	23.5%	501.2	153.96	469.41	144.20	532.99	163.73
n -Pentane	29.5%	88.4	36.99	82.79	34.64	94.01	39.34
1-Pentene	23.9%	38.06	11.95	35.65	11.19	40.47	12.71
Azeotrope requirements (= B2)			277.94		262.51		293.37
Rxn consumption (= MeOH feed)			230.37		276.44		184.29
Total MeOH			508.31		538.95		477.66
MeOH to prereactor			313		313		313
MeOH to reactive distillation			195.31		225.95		164.66

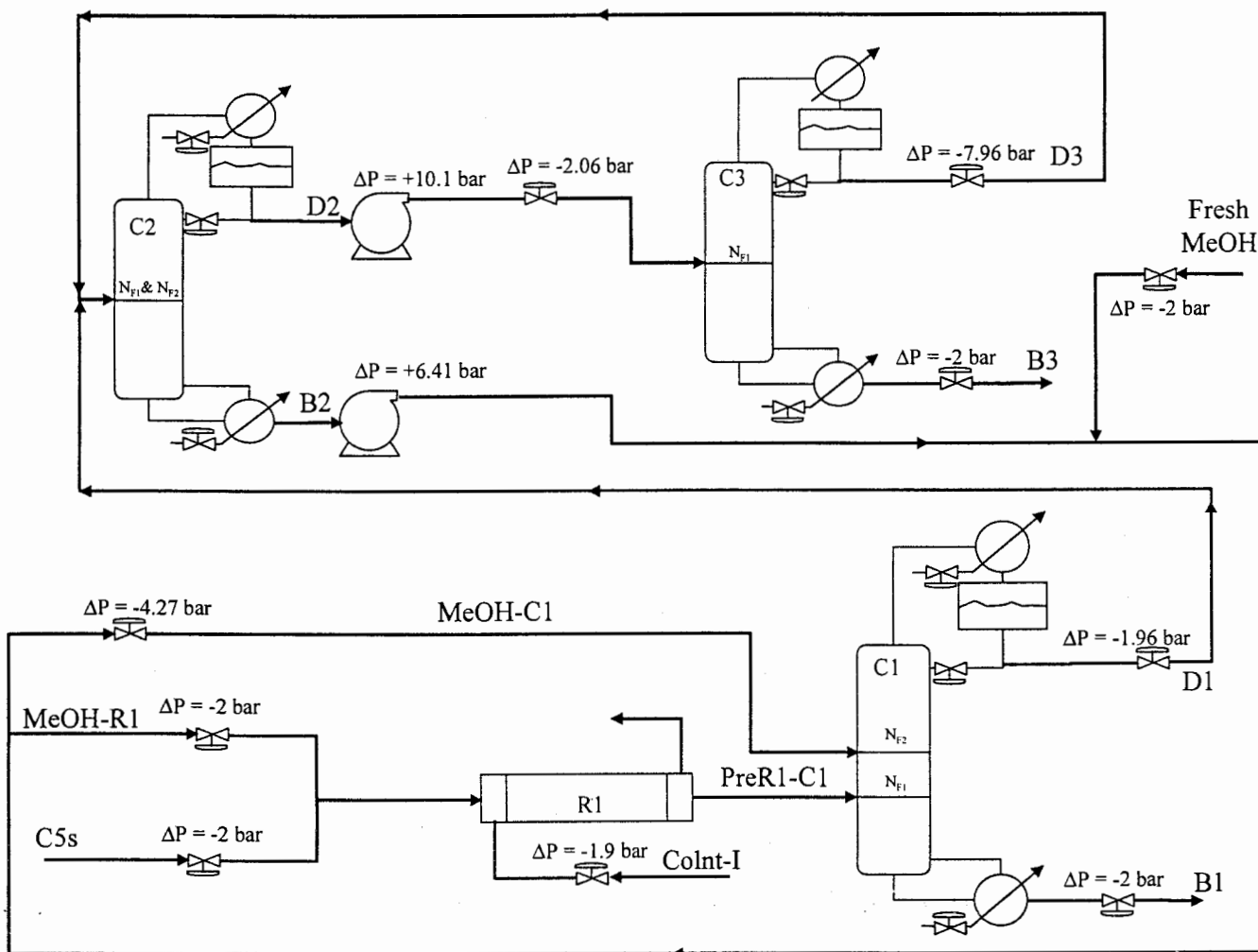

Figure 3. Process flowsheet diagram.

The fresh methanol fed to the system is essentially equal to the amount of methanol consumed in the reactions. Table 2 shows the flow rate of mixed C5 feed, the amount of methanol needed for the reactions and for the azeotropes. It also shows the same calculations for two other cases. The first case ($+\Delta z$) is for an increase in the isoamylenes (2M1B and 2M2B) by 20% while reducing the other components such that the total feed flow rate is not changed. The second case ($-\Delta z$) is for the reverse; that is, the isoamylenes are reduced 20% and others are increased to keep the total flow rate constant. These two cases are discussed in the control analysis section where they are considered as feed composition disturbances.

As shown in Table 2, the amount of fresh methanol depends on the conversion level of the isoamylenes. The $B2$ is calculated from the azeotropic requirements. Although the fresh methanol found in these calculations is exact (attributed to the overall mass balance), the $B2$ flow rate is approximate because the calculation was based on the requirements of each binary azeotrope. The actual multicomponent azeotropic requirements (and approximately $B2$ flow rate) are found using rigorous simulations. Typically, the approximate calculation result is more than the actual rigorous result by only 1.8%. The distillate in the reactive column is typically close to the azeotropic

composition. If methanol is provided in excess, most of the unconverted methanol will leave in the bottoms but some of it could be recovered at the top of column, which makes the distillate somewhat further from the azeotropic composition.

Prereactor design

Subawalla used a fixed-temperature plug-flow reactor (PFR). His reactor is 6 m in length and 1.5 m in diameter. It is packed with 9544 kg of catalyst with a packing density of 900 kg of catalyst/ m^3 of reactor volume. Because Aspen Dynamics does not support fixed-temperature PFRs, we used a cocurrent cooled reactor. The reactor volume we used is the same as that of Subawalla.

We designed the reactor to have multiple tubes 1 in. (2.54 cm) in diameter. The total tube volume is equal to Subawalla's reactor volume: $[\pi(1.5)^2/4](6) = 10.6 \text{ m}^3$. The volume of each tube is $[\pi(0.0254)^2/4](6) = 0.00304 \text{ m}^3$ per tube. Therefore the number of tubes is 3488.

The reactions take place inside the tubes, and the coolant flows through the shell outside the tubes. The shell-side volume is assumed to be equal to the total volume of the tubes.

Table 3. Design Parameters for Three Columns

	C1	C2	C3
N_T	33	8	8
N_S	10	5	5
N_R	4	3	3
N_{Rxn}	19	—	—
N_{F1}	6	5	5
N_{F2}	11	5	—
D (kmol/h)	1078	2227	1421
B (kmol/h)	234.3	273	805.6
R (kmol/h)	4314	1113	1421
Q_r (GJ/h)	129.6	68.90	85.73
P (bar)	4	2	10
T_D (°C)	46.03	44.82	45.13
T_B (°C)	116.1	84.15	108.3
T_{F1} (°C)	90.30	58.93	102.8
T_{F2} (°C)	80.80	58.93	—
D_c (m)	6.9	3.9	5.7
M_D (m ³)	90	56	49
M_B (m ³)	137	17	128
M_{cat} (kg/tray)	1100	—	—
C5 conversion* (%)	84	—	—

*Conversion is based on C5 input and output of reactive column.

Therefore, the diameter of the reactor vessel can be calculated as

$$2(10.6) = \frac{\pi(D_{\text{reactor}})^2(6)}{4} \Rightarrow D_{\text{reactor}} = 2.12 \text{ m}$$

A more detailed process flowsheet diagram is given in Figure 3. The design parameters for the three columns and the reactor are given in Tables 3 and 4. The key streams are given in Table 5. The overall isoamylenes conversion is 92%. Figures 4–6 show the temperature and the liquid mole fraction profiles of the three columns. For ease of understanding and better clarity, 2M1B and 2M2B are lumped in one line (2M1B + 2M2B) in the mole fraction profile figures. The *i*-pentane and *n*-pentane are lumped in one line (C5). The 1-pentene and 2-pentene are lumped in one line as well (C₅[≠]). Figure 7 shows the temperature profile inside the prereactor and the coolant temperature. This figure shows that the reactor cooling area is large and that the outlet temperature of this reactor would be controlled easily by the coolant flow rate.

Effect of excess methanol

The methanol feed to the reactive column is important, especially in the dynamics of the system. Feeding less methanol than required, as shown in Table 2, will result in reducing the conversion (Subawalla and Fair, 1999). This occurs because the distillate typically leaves around the azeotropic mixture. When the methanol is reduced, the amount of methanol needed in the azeotrope (which is changed only slightly because the C5s feed has changed little by the amount of the unreacted isoamylenes) does not change. This means less methanol is available for reaction. Small increases in methanol will result in increasing the conversion (about 5% from the base case). Further increasing methanol will result in either (1) reducing TAME purity, given that most of the excess methanol will leave the column in the bottoms, or (2) reducing the conversion and TAME production rate by having some of the TAME leave in the distillate. The first situation is called “direct

synthesis” and the second is called “indirect synthesis” (Giessler et al., 2001; Ung and Doherty, 1995). Both of these situations are undesirable. Therefore, the amount of methanol fed to the reactive column should always be adjusted according to isoamylenes content in the C5s feed and level of conversion, as shown in Table 2.

Figure 8 shows the ternary residue curve map for 2M2B, methanol, and TAME. The highest conversion and purity of TAME is attained when the bottoms is located at the TAME vertex and the distillate is located at the azeotrope point. Additional methanol will result in either (1) having a mixture of methanol and TAME in the bottoms (low purity) and the azeotrope in the distillate in the direct synthesis or (2) having high-purity TAME bottoms and a mixture of C5s/methanol/TAME in the distillate (low conversion and production rate) as a consequence of the distillation boundary in the indirect synthesis. Therefore, despite the apparent excess of methanol, the TAME reactive column must be operated essentially as a “pseudo-*neat*” system running at stoichiometric conditions in terms of the reactants. An effective control system must handle these inherent process constraints.

As a final remark in this section, it is worth noting that the developed flowsheet is not the only possible flowsheet to produce TAME and recover methanol and C5s. However, this flowsheet is one logical extension of the base design developed by Subawalla. Other alternatives include (1) use of an additional column to treat impure methanol/TAME reactive distillation bottoms and recover TAME in the bottoms and recycle methanol/TAME azeotrope back to the reactive column, and (2) use of extractive distillation to extract the methanol from the methanol/C5s azeotropes (Stichlmair and Fair, 1998). The first alternative might have the advantage of permitting the use of excess of methanol, which might eliminate the need for a composition analyzer, as discussed in next section. It is beyond the scope of this work to compare these various flowsheets and recovery systems in terms of their economics and controllability.

Table 4. Design Parameters for Prereactor

	R_1
D_r (m)	2.12
L (m)	6
Number of tubes	3488
D_t (m)	0.0254
U (kW m ⁻² K ⁻¹)	0.5678
Rate of heat removal (GJ/h)	1.1297
T_i (°C)	65.10
T_o (°C)	81.69
F_i (kmol/h)	1353
F_o (kmol/h)	1228
$T_{c,i}$ (°C)	30.04
$T_{c,o}$ (°C)	81.68
F_c (kmol/h)	300
M_{act} (kg)	9544
C5 conversion* (%)	50
Total reactor and column conversion** (%)	92

* Conversion is based on C5 input and output of prereactor.

**Conversion is based on C5 input to prereactor and C5 output of reactive column.

Table 5. Details of Key Streams in TAME Flowsheet

Mole Flow (kmol/h)	Fresh MeOH	C5s	MeOH-R1	PreR1-C1	MeOH-C1	B1	D1	B2	D2	B3	D3
Methanol	230.41	0	313	187.7	190.414	0	273.014	273	454.5	0.014	454.864
2M1B	0	85.6	0	12.98	0	0.04	3.28	0	7.17	3.28	3.89
2M2B	0	164.8	0	112.1	0	1.23	15.45	0	24.6	15.45	9.15
TAME	0	0.104	0	125.4	0	230.5	0	0	0	0	0
<i>n</i> -Pentane	0	88.4	0	88.4	0	0.19	88.21	0	151.9	88.21	63.69
<i>i</i> -Pentane	0	501.2	0	501.2	0	0.2	501	0	1240.4	501	739.4
1-Pentene	0	38.06	0	38.06	0	0.12	37.94	0	86.81	37.94	48.87
2-Pentene	0	161.7	0	161.7	0	2.06	159.64	0	261.26	159.64	101.62
Total (kmol/h)	230.41	1039.86	313	1227.54	190.414	234.34	1078.53	273	2226.64	805.534	1421.48
Temperature (°C)	70	70	78	74.60	78.06	116.1	46.03	84.15	44.82	108.3	45.13
Pressure (bar)	10.5	8.5	8.5	4.28	4.23	2.34	2.04	2.09	2	8.09	2.04

Control Study

The overall control objective for this flowsheet is to maintain the TAME purity and the isoamylenes conversion. Therefore, the reactive column is the critical unit and is the key player in achieving good overall control of this flowsheet. However, other units have their own tasks in the flowsheet and must be controlled to achieve these tasks. The flowsheet consists of four units: a prereactor, a reactive column, and two conventional distillation columns. To come up with an overall effective control structure, we need to look at each individual unit and find a good way of controlling each to achieve its objective and then consider all the units together from a plantwide control perspective. In this work, the level controllers are P only and all others are PI controllers. All the controllers are tuned using the Tyreus-Luyben tuning method (Tyreus and Luyben, 1992), with the ultimate gain and ultimate period calculated using the relay-feedback method (Yu, 1999). The pressure in each column is controlled by the condenser heat duty. All temperature-control loops have dead times of 4 min, which is quite conservative. The composition control loop has a dead time of 8 min.

Control of prereactor

The first unit is the prereactor (R1). This is a plug-flow reactor with a cocurrent coolant. The objective of this reactor is to carry out part of the reaction. There is no limit on the amount of conversion that needs to be accomplished in this reactor because it is followed by the reactive column that has the capacity to make up any deficiency in the reactor conversion.

The coolant flow rate will be used to control the outlet temperature of the reactor. Because the reactions are both reversible and not highly exothermic, there are no hot spots inside in the reactor (see Table 1 and Figure 7). The reactor will not have the problem of reaction runaway. Therefore, even though the prereactor plays an important role in carrying most of the reaction, the control of this unit is not critical to the overall control objective of the flowsheet.

The feeds to the reactor are subcooled methanol and subcooled C5s. The inlet temperature to the reactor does not significantly affect the overall performance and is not expected to vary much. A decrease of 20°C in the inlet temperature will result in reducing the overall isoamylenes conversion by only 1.86%. If large changes in inlet temperature are anticipated, a preheater should be installed and used to control reactor inlet temperature.

Control of reactive column

The reactive distillation column (C1) is the core of this flowsheet. The objective is to make sure we convert the desired amount of isoamylenes and to produce the TAME in the desired purity. In the steady-state section we highlighted the importance of feeding the column an amount of methanol that corresponds to the isoamylenes feed rate plus the VLE azeotropic requirements. Therefore, the column operation is considered "pseudo-neat," and the control system must adjust the methanol feed to the reactive column to achieve this precise balance.

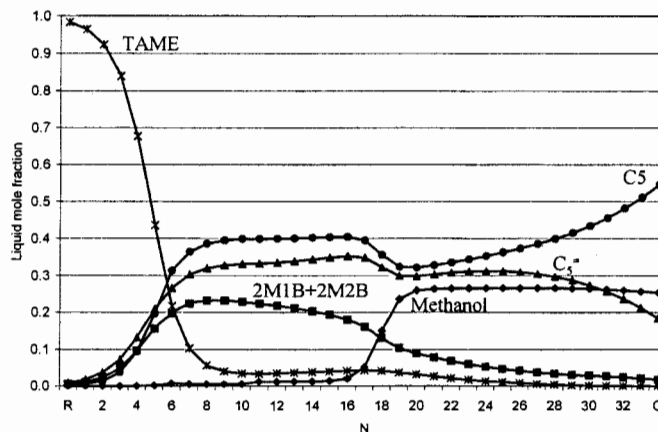
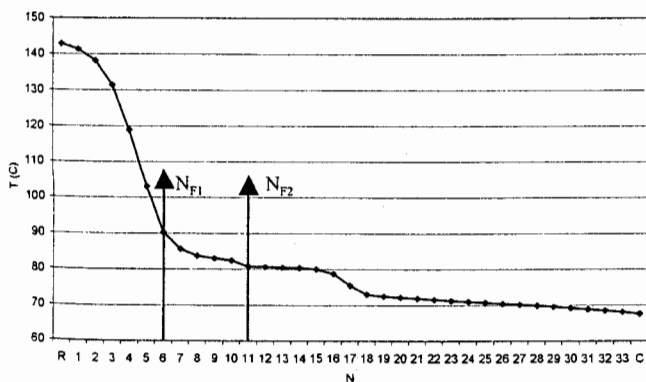

Figure 4. Column 1 temperature and composition profiles.

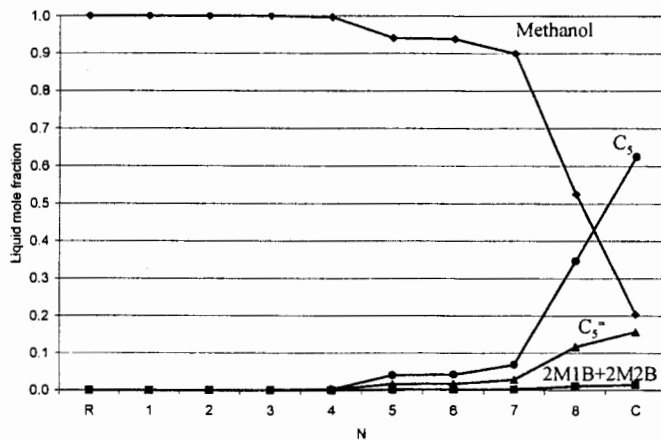
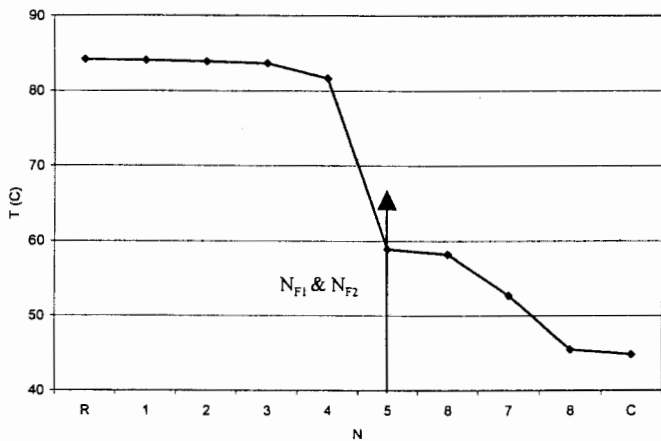

Figure 5. Column 2 temperature and composition profiles.

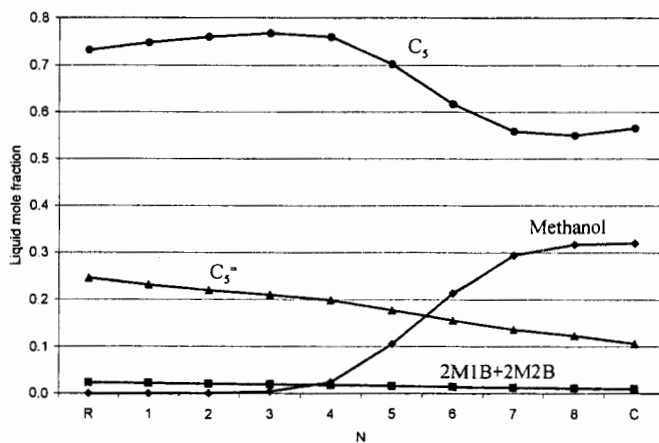
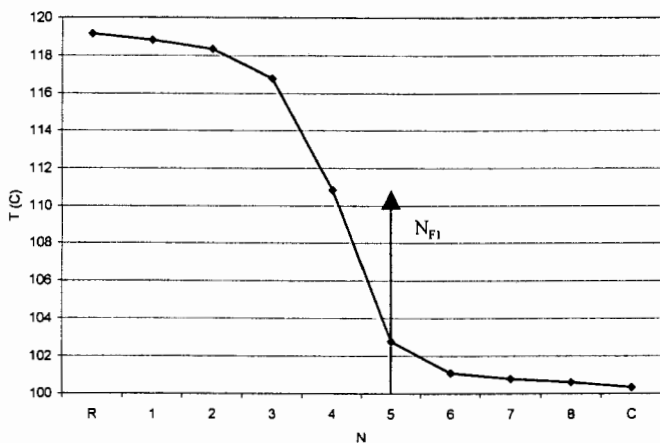

Figure 6. Column 3 temperature and composition profiles.

One of the objectives of this study is to see whether a control structure that was effective for a similar reactive distillation system will be effective for the TAME system. The ETBE reactive distillation is considered of the same class as the TAME reactive distillation. Both have two reactants, one product and light inerts. We studied the control of the ETBE reactive distillation "neat" operation in a previous article (Al-Arfaj and Luyben, 2002a). A control structure that consists of internal composition control of one of the reactants by the reactant feed rate and a temperature control of a tray in the stripping zone by the heat input was found to be effective.

As shown in Figure 9, in the TAME system the methanol feed to the reactive column is used to control an internal methanol composition. The C5s feed is used as the production handle. Although both fixed reflux ratio and fixed reflux strategies were found to work, fixed reflux was selected because it is desirable to take the azeotrope in the distillate to the recovery units and not to recycle it back to the reactive column. The singular value decomposition method (Moore, 1992) is used to select the trays for both temperature and composition control. The temperature on Tray 4 is controlled by the heat input to the reboiler, and the methanol concentration on Tray 18 is controlled by the methanol feed to the reactive column.

Control of two recovery columns

The other two columns (C2 and C3), which constitute the recovery system, have an important role in this flowsheet. The objective of the methanol recovery column is to make sure only methanol is recovered in the bottoms. Similarly, the C5s recovery column must ensure only C5s leave in the bottoms by

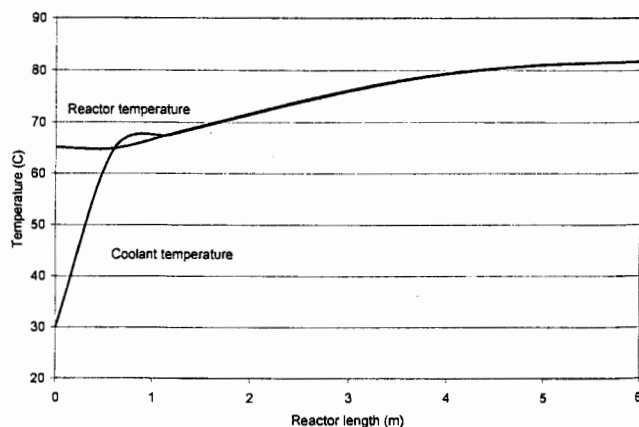

Figure 7. Temperature profile inside the prereactor.

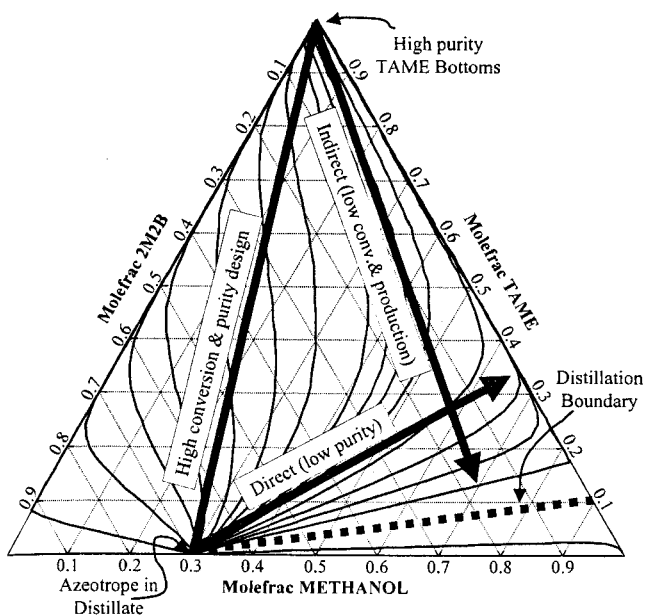

Figure 8. Residue curve for methanol/TAME/2M2B.

recycling the required amount of both methanol and C5s back to the methanol recovery column. To achieve the desired separation in both columns, temperature control is used. Both columns use a fixed-reflux ratio because it helps the separation, especially when there are rate changes, and to scale the reflux up and down according to the changes made by the heat input. Tray 4 on each column is controlled by the heat input.

Other plantwide control loops

The C5s feed is used as the production handle. The methanol feed flow to the reactor is ratioed to the C5s feed flow rate. The ratio is set at the steady-state ratio of the two flows. This ratio control helps to quickly adjust the methanol flow to changes in C5s feed flow rate.

It is important to check the overall methanol inventory. The base of the methanol recovery column is high-purity methanol. When the methanol starts to build up somewhere in the plant it will show up as an increase in the base level of the second column. Similarly, if methanol is depleted from the system that level will drop. Therefore, the base level of the methanol recovery column should be controlled by the fresh methanol feed. The proposed control structure is shown in Figure 9.

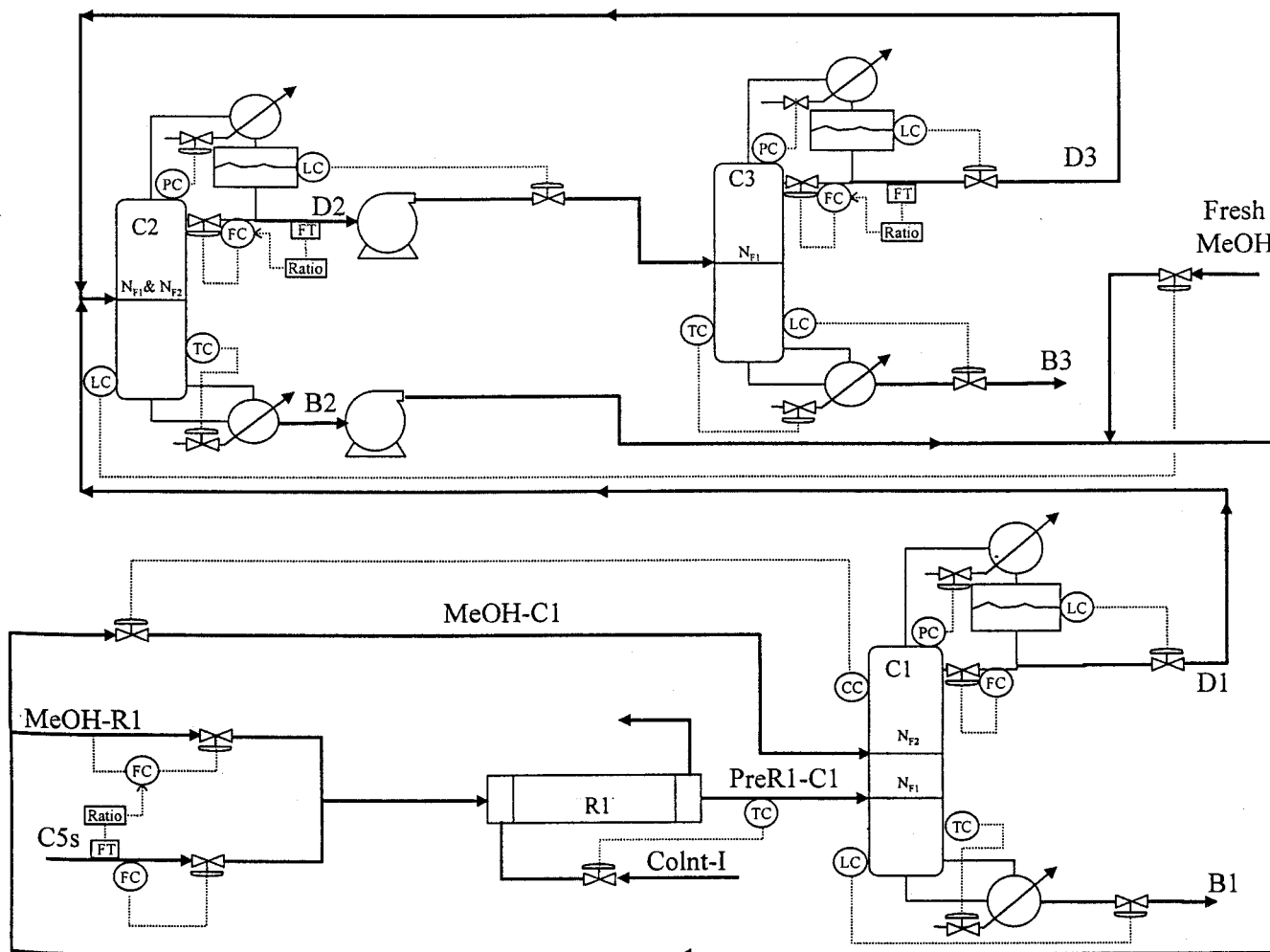

Figure 9. Control structure.

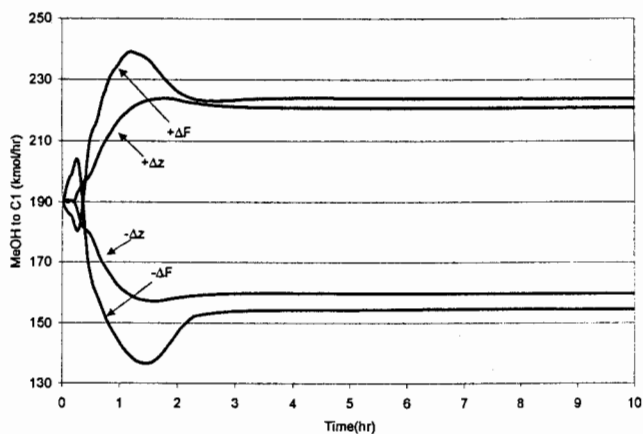
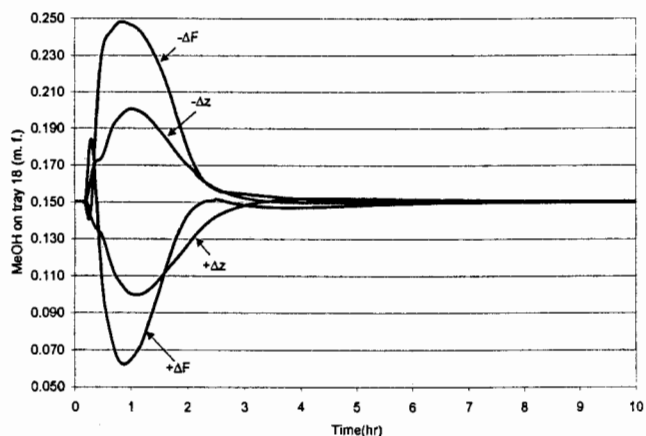

Figure 10. Internal composition controller.

Disturbances

Two kinds of disturbances were introduced to examine how well this control structure works. The first is a feed rate change and the second is the feed composition change. In the feed rate change, the C5s feed is changed $\pm 20\%$ ($\pm \Delta F$). In the feed composition changes, the total isoamylenes (2M1B + 2M2B) in the C5s feed is changed by $\pm 20\%$ ($\pm \Delta z$) while keeping the total flow fixed. Table 2 shows the component flow rates for the C5s feed in the two cases of $\pm \Delta z$. It also shows approximately how much the composition controller should increase or decrease the methanol feed to the reactive column to compensate for those feed composition changes. The disturbance magnitudes of $\pm 20\%$ are probably more than what is experienced in practice; however, they give a good indication of how robust this control structure is.

Results and Discussion

Figures 10 through 17 show results for the four disturbances. We select the negative change in the C5s flow rate to illustrate what occurs throughout the process as the disturbance works its way through the units and the control system responds.

Reactive column (C1)

Figure 10 shows the response of the internal composition controller in the reactive column. The reduction in reactants fed

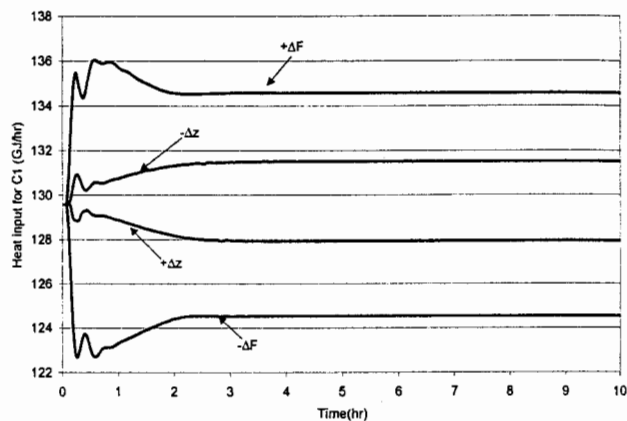
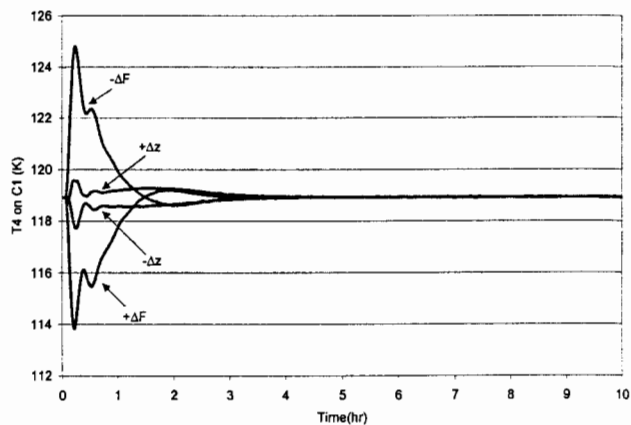

Figure 11. Column 1 temperature controller.

to the column produces an increase in the internal composition of methanol, and the controller responds properly by decreasing the methanol feed. The temperatures in the stripping zone increase as the C5s feed rate decreases, as shown in Figure 11. In response, the heat input decreases to bring the temperature back and maintain the desired separation. The TAME production decreases, so the bottoms flow rate decreases. Figure 12 shows the TAME purity. Although the purity of TAME is not controlled directly, it is held within a very small range.

Notice that the ratio controller on the prereactor methanol

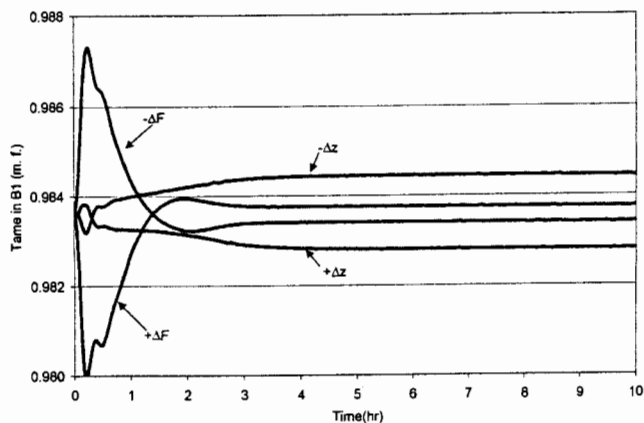

Figure 12. Column 1 TAME purity.

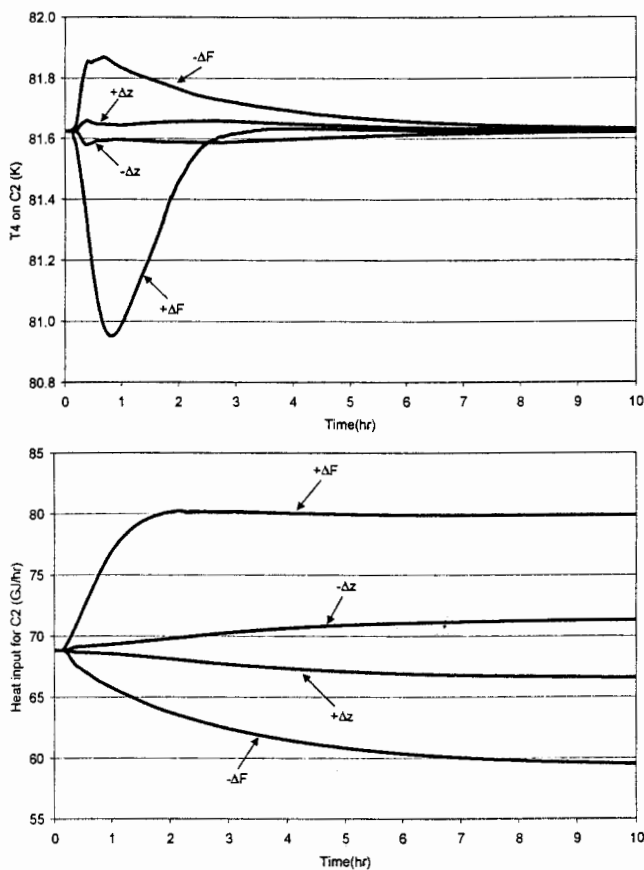

Figure 13. Column 2 temperature controller.

feed decreases this stream, and this helps to reduce the methanol fed to the reactive column. However, this decrease is not sufficient to compensate for the drop in methanol consumption, so the internal composition controller must take care of balancing the reactants.

Methanol recovery column (C2)

The two recovery columns display some interesting and unexpected behavior when disturbances occur. This is attributed, in part, to methanol having different effective volatility in the two columns. In the C2 column, methanol is the heavy component, leaving in bottoms. In the C3 column, methanol leaves in the azeotrope in the distillate, so it acts like a light component.

The temperature control for the methanol recovery column is shown in Figure 13. The decrease in the C5s feed flow reduces the distillate *D1* feeding the methanol recovery column. Consequently, the temperature on Tray 4 of Column 2 increases and the heat input is decreased to retain the desired temperature and separation. This decreases the flow rate of distillate *D2*. This increase in Tray 4 temperature means more methanol is present on this tray and throughout the column. The result is a temporary increase in methanol concentration in the *D2* distillate until the temperature controller brings the temperature back to the setpoint; thus the feed flow rate to the C3 column decreases, but the methanol concentration in this feed increases (see Figure 14). These two effects produce an interesting response in the C3 column, as discussed below.

There are three effects that influence the methanol balance in this column. First, the amount of methanol fed decreases because *D1* decreases. Second, the distillate flow *D2* decreases, so less methanol goes out the top. Third, there has been a reduction in the bottoms flow rate. This reduction is caused by the action of two controllers: (1) the ratio controller on the prereactor methanol feed reduces this methanol stream when the C5s feed decreases, and (2) the internal composition controller in the reactive column decreases the methanol fed to C1. The other feedstream to this column, the recycle stream *D3* from the C5s recovery column, decreases as discussed below.

The net effect of these competing changes is an increase in the liquid level in the base of the methanol recovery column. This is precisely what one would expect, given that less methanol is being consumed in the reactions. The base level controller then reduces the fresh methanol feed flow. The fresh methanol flow, the methanol from the bottoms of the second column, and the methanol to the prereactor are shown in Figure 15.

C5s recovery column (C3)

Figure 16 shows the temperature control for Tray 4 in the C5s recovery column. There is a temporary decrease in the tray temperature, despite the decrease in the column feed flow rate. This is caused by the higher methanol concentration in the feed to C3. Recall that methanol is a light component in this column, so an increase in methanol in the feed causes a reduction in temperature.

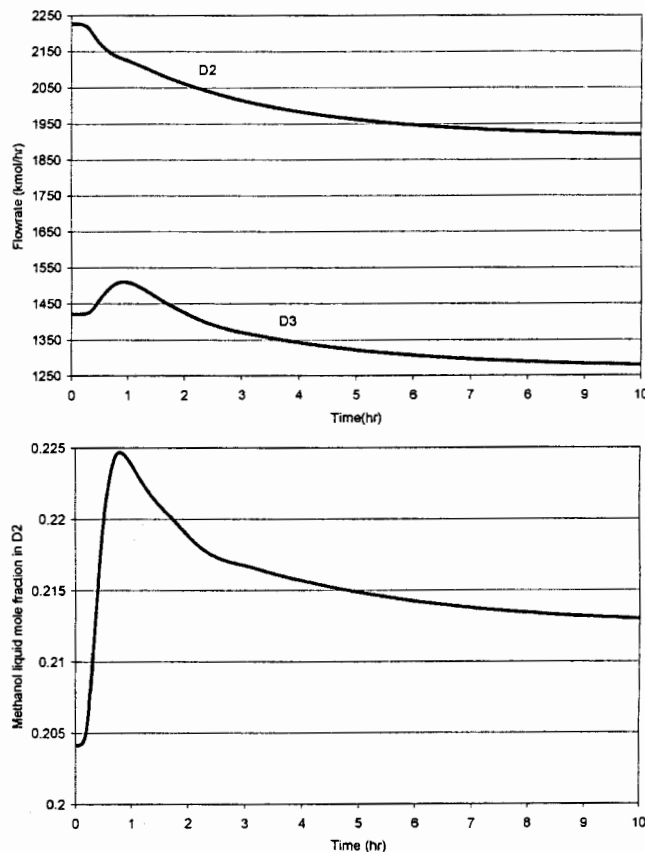

Figure 14. Response of *D2*, *D3*, and methanol mole fraction in *D2* to $-\Delta F$ disturbance.

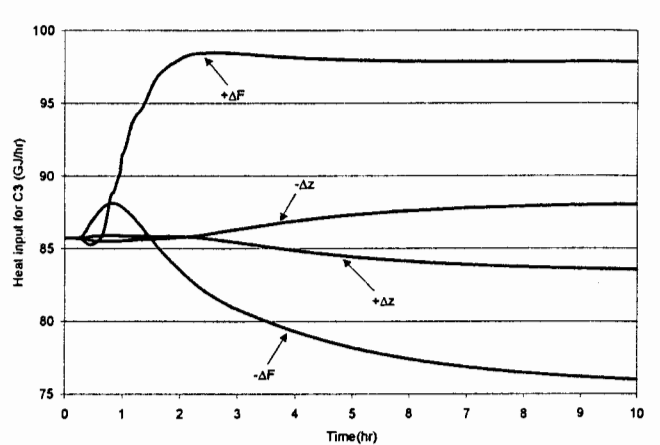
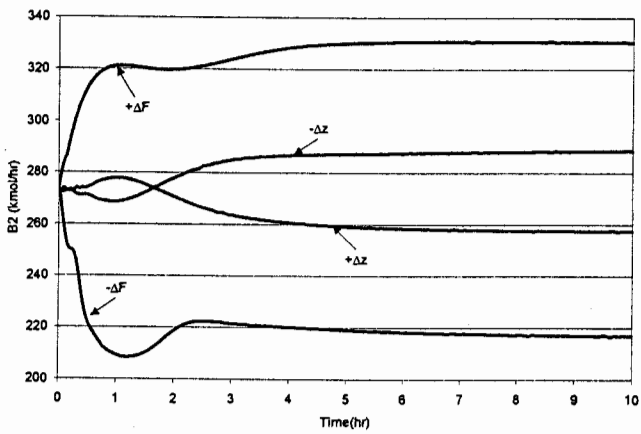
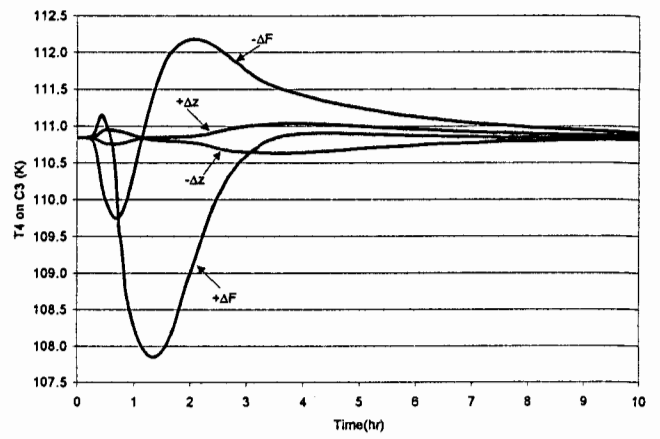
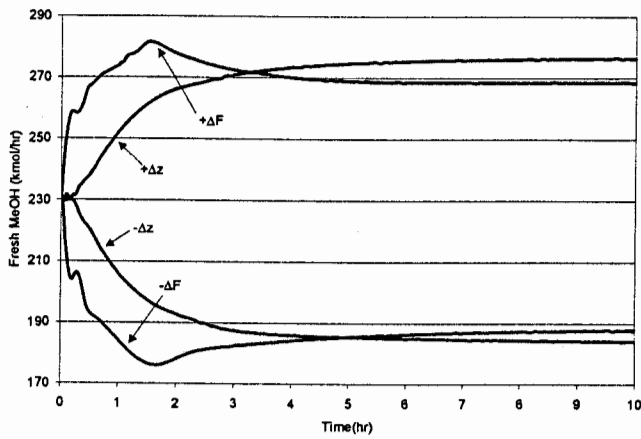

Figure 16. Column 3 temperature controller.

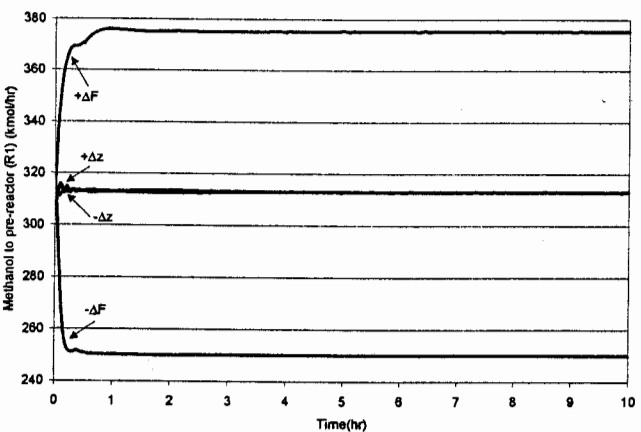

Figure 15. Fresh methanol feed.

Eventually, the methanol concentration in *D2* begins to decrease, as discussed in the previous section. This composition change and the decrease in feed flow rate produce an increase in Tray 4 temperature. The final steady state has lower heat input, and the flow rates of both *D2* and *D3* are lower (see Figure 14).

Overall discussion

Responses to other disturbances can be explained by similar reasoning. It is worth noting that the system settles down in about 4 h for all kinds of disturbances. The overall base-case isoamylenes conversion is 92%. The calculated conversion responses for the four disturbances are shown in Figure 17. The

control structure was able to maintain the conversion reasonably well for most disturbances. The worst case is the increase in the C5s feed rate where the conversion decreases about 2.5%, to 89.5%. This decrease is not unexpected because of the magnitude of the disturbance. If the decrease is not tolerable, the reactive distillation design could be modified at the steady-state stage to achieve a higher conversion. For example, the reactive column could be designed such that the overall conversion is 96%. This can be achieved by a small increase in the

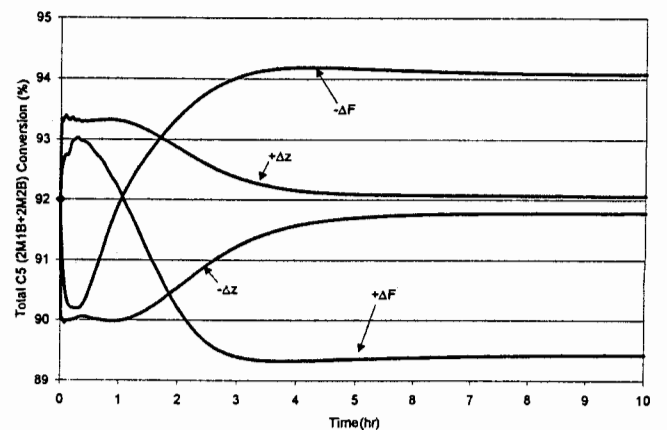

Figure 17. Overall conversion.

methanol flow to the reactive column (an increase of about 10 kmol/h).

Conclusion

In this work we have studied the plantwide design and control of the TAME process with reactive distillation. The design of the prereactor and reactive distillation column was taken from the literature. A recovery system was synthesized to complete the flowsheet. An effective control structure was developed and tested by rigorous dynamic simulation. The reactive distillation column was found to be the central part of the whole flowsheet in terms of both the steady-state design and the dynamic controllability. When the reactive distillation column is designed and controlled properly, the rest of the plant should be easy to handle.

A very important conclusion is the applicability of an effective control structure on different reactive distillation systems of the same class. The system we studied herein was the production of TAME, which is an etherification process. Previously, we studied the production of ETBE, which is also an etherification process. Although they differ somewhat in the physical and chemical properties, they are similar in the sense that they both have two reactants, one heavy product, and light inert. After carefully examining the high-conversion TAME process, we concluded that it should be considered a "pseudo-neat" process because both reactants must be used in the correct proportions to maintain high conversion and the purity of TAME. Using this analogy, we developed a control structure for the TAME reactive distillation based on the control structure that was used with the ETBE "neat" reactive distillation. The other units of the flowsheet were controlled to achieve the objective of each unit. The overall mass balance and the methanol inventory were taken into consideration to avoid reactant buildup or depletion. Combining all these considerations resulted in a plantwide control structure that is very effective.

In conclusion, it is found that effective control structures could be used interchangeably with minor changes on different reactive distillation systems of the same class.

Acknowledgments

The authors acknowledge King Fahd University of Petroleum and Minerals, Dhahran, Saudi Arabia for supporting this research.

Notation

B = bottoms, kmol/h
 B_1 = bottoms of first column
 B_2 = bottoms of second column
 B_3 = bottoms of third column
 C_1 = first column (reactive distillation)
 C_2 = second column (reactive distillation)
 C_3 = third column (reactive distillation)
 D = distillate, kmol/h
 D_1 = distillate of the first column
 D_2 = distillate of the second column
 D_3 = distillate of the third column
 D_c = column diameter, m
 D_r = reactor diameter, m
 D_t = tube diameter, m
 F_c = coolant flow, kmol/h

F_i = reactor inlet flow, kmol/h
 F_o = reactor outlet flow, kmol/h
 L = reactor length, m
 M_B = base holdup, m³
 M_{cat} = catalyst mass, kg
 M_D = reflux drum holdup, m³
 N_{F1} = first feed tray
 N_{F2} = second feed tray
 N_R = number of rectifying trays
 N_{Rxn} = number of reactive trays
 N_S = number of stripping trays
 N_T = total number of trays
 P = pressure, bar
 Q_r = reboiler heat input, GJ/h
 R = reflux, kmol/h
 R_1 = prereactor
 T_B = bottoms temperature, °C
 $T_{c,i}$ = coolant inlet temperature, °C
 $T_{c,o}$ = coolant outlet temperature, °C
 T_D = distillate temperature, °C
 T_{F1} = temperature of the first feed tray, °C
 T_{F2} = temperature of the second feed tray, °C
 T_i = reactor inlet temperature, °C
 T_o = reactor outlet temperature, °C
 x = liquid mole fraction

Literature Cited

- Agreda, V. H., L. R. Partin, and W. H. Heise, "High-Purity Methyl Acetate via Reactive Distillation," *Chem. Eng. Prog.*, **86**, 40 (1990).
- Al-Arfaj, M. A., and W. L. Luyben, "Comparison of Alternative Control Structures for an Ideal Two-Product Reactive Distillation Column," *Ind. Eng. Chem. Res.*, **39**, 3298 (2000).
- Al-Arfaj, M. A., and W. L. Luyben, "Control Study of ETBE Reactive Distillation," *Ind. Eng. Chem. Res.*, **41**, 3784 (2002a).
- Al-Arfaj, M. A., and W. L. Luyben, "Control of Ethylene Glycol Reactive Distillation Column," *AIChE J.*, **48**, 905 (2002b).
- Al-Arfaj, M. A., and W. L. Luyben, "Design and Control of One-Reactant-Two-Products Reactive Distillation: Olefin Metathesis Case," *Chem. Eng. Sci.*, **53**, 715 (2002c).
- Al-Arfaj, M. A., and W. L. Luyben, "Comparative Control Study of Ideal and Methyl Acetate Reactive Distillation," *Chem. Eng. Sci.*, **53**, 5039 (2002d).
- Giessler, S., R. Y. Danilov, R. Y. Pisarenko, L. A. Serafimov, S. Hasebe, and I. Hashimoto, "Systematic Structure Generation for Reactive Distillation Processes," *Comp. Chem. Eng.*, **25**, 49 (2001).
- Kiviranta-Paekkoenen, P. K., Personal communication (2001).
- Luyben, W. L., "Economic and Dynamic Impact of the Use of Excess Reactant in Reactive Distillation Systems," *Ind. Eng. Chem. Res.*, **39**, 2935 (2000).
- Moore, C. F., "Selection of Controlled and Manipulated Variables," Chapter 8 in *Practical Distillation Control*, W. L. Luyben, ed., Van Nostrand Reinhold, New York (1992).
- Rihko, L. K., P. K. Kiviranta-Paekkoenen, and A. O. I. Krause, "Kinetic Model for the Etherification of Isoamylenes with Methanol," *Ind. Eng. Chem. Res.*, **36**, 614 (1997).
- Rihko, L. K., and A. O. I. Krause, "Kinetics of Heterogeneously Catalyzed *tert*-Amyl Methyl Ether Reactions in the Liquid Phase," *Ind. Eng. Chem. Res.*, **34**, 1172 (1995).
- Stichlmair, J. G., and J. R. Fair, *Distillation: Principles and Practices*, Wiley, New York (1998).
- Subawalla, H., and J. R. Fair, "Design Guidelines for Solid-Catalyzed Reactive Distillation Systems," *Ind. Eng. Chem. Res.*, **38**, 3696 (1999).
- Tyreus, B. D., and W. L. Luyben, "Tuning PI Controllers for Integrator/Dead Time Processes," *Ind. Eng. Chem. Res.*, **31**, 2625 (1992).
- Ung, S., and M. F. Doherty, "Synthesis of Reactive Distillation Systems with Multiple Equilibrium Chemical Reactions," *Ind. Eng. Chem. Res.*, **34**, 2555 (1995).
- Yu, C.-C., "Autotuning of PID Controllers," Springer-Verlag, London (1999).

Manuscript received Jun. 18, 2003, and revision received Sep. 24, 2003.