

AIRFLOW PATTERNS AND STACK PRESSURE SIMULATION IN A HIGH RISE RESIDENTIAL BUILDING LOCATED IN SEOUL

Khoukhi Maatouk

Abstract

Buoyancy forces due to air density difference between outdoor air and indoor air cause stack effect in high-rise buildings in cold climates. This stack effect occurs mainly at the core of the building such as the stairway and elevator shafts and causes many problems such as the energy loss caused by air flow, the blocked elevator door and discomfort due to inflowing of strong outdoor air. The main purpose of this work is to model the airflow pattern in a high-rise building during the winter period by mean of COMIS. The presented building which is situated in Korea contains 30 floors above the ground level and 5 basement floors. Using COMIS, the simulation has been carried out for the entire building. However, the simulation failed due to the huge number of zones and interactions between them. Therefore, a model of building which contains 14 floors with 5 floors in the basement has been considered; and a simplified model based on the considered one has been constructed and compared with the 14 floors model. The simplified model consists on reducing the number of floors by combining a certain number of stories into one so that to enable the simulation to be carried on with a minimum number of zones and links. The result of the simulation shows that this approach could be used with accuracy still being satisfied. Therefore, the simplified procedure has been extended and applied to the high rise building model with 30 stories above the ground level and 5 stories in the

basement. The effect of the exterior wall air-tightness of the building with 30 stories on the stack pressure and airflow by infiltration and/or by exfiltration has been investigated. The result shows that the total air by infiltration and/or exfiltration within the elevator shafts increases with the decrease of the level of the air-tightness of the exterior wall of the building. It has been also shown that a huge amount of air infiltrates through the shuttle and emergency elevator shafts from the basement.

Keywords

Stack pressure; airflow; COMIS, simulation; air-tightness of exterior wall.

Introduction

Recently many tall buildings have been constructed in Korea. These buildings comprise of over 40 floors. Due to this height, they form a tall air column inside the building and another one outside. The normal stack effect occurs because the air in the building is warmer and less dense than outside. When the outside air is warmer than the building air, there is a natural tendency for downward air flow, or reverse stack effect, in shaft (Khoukhi et al.,

All diagrams were developed by the author unless otherwise noted

2007). Problems caused by this stack effect are the energy loss caused by air flow, the sticky elevator doors, and the loud noise at the lobby entrance (Yu et al., 2004).

Several works discussing the stack effect in medium and high-rise buildings have been investigated by numerous authors. Recently, Khoukhi et al. (2007) have investigated the effect of the wind speed and its direction on the stack pressure in medium-rise building in cold region of China. J. Yu et al (2004) have evaluated the stack effect according to the shape and the window area ratio of lobby in high-rise building. The investigation of the air quality in newly-constructed high-rise multi-family houses and the improvement of the indoor air quality have been carried out by Hyung et al (2004). The influence of architectural elements on stack effect problems in tall residential buildings has been studied by Koo et al. (2004). Some problems about the stack effect have been studied and partial solutions were proposed (Tamura and Wilson, 1967 and Lovatt, 1994). For the stack effect, mechanical ventilation systems were used to control pressure differences (Tamblyn, 1991 and 1993). Nevertheless, this may lead to other problems with regard to the system efficiency (Yu et al., 2004).

We have little understanding about the stack effect phenomena that occurs in buildings since it is affected by the envelope. Those parameters vary strongly from one building to another which led to the study of the stack effect case by case. However, the plan to solve the problem should be made on the schematic design stage.

The main purpose of this work is to model the

airflow pattern in a high-rise building by means of COMIS. The present building which is situated in Korea contains 30 floors above the ground level and 5 basement floors (B5F+30F+Roof). Using COMIS, the simulation has been carried out for the entire building. However, the simulation failed due to the huge number of zones and interactions between them, since the COMIS model presents some limitations with regards to parameters such as the number of zones and links, the number of pollutants, the number of wind pressure points, the number of façade elements, and so on. Therefore, a building model which contains 14 floors with 5 floors in the basement (B5F+14F+Roof) has been considered. This model has been decided with a maximum of zones and links regarding the number of the zones and links that can allow carrying the simulation using COMIS. A simplified model (B5F+14F+Roof-simplified) based on the decided one has been constructed and compared with B5F+14F+Roof model. The simplified model focuses on reducing the number of floors by gathering a certain number of stories into one so that to enable to carry on the simulation with a minimum number of zones and links. The simplified proposed model has been validated compared to the original one in order to extend this approach to the high-rise building with more than 30 stories.

Building Description -- Climate Conditions

The selected tall residential building was built recently. This building, which is situated in Seoul (latitude= 37.1 N, longitude= 126.6 E), contains 30 floors above the ground level and 5 floors in the basement and a roof. Figure 1 shows the layout of the building model. The floor area is

900 m².

The three levels B5F, B4F and B3F are intended for car parking. B2F and B1F are the commercial zones. The first floor area is divided into two zones which have independent access from the outside. However, only the building occupants can access the lobby from the commercial zone and vice versa. From 2F to 30F, each story contains 4 apartments with the central core serving as a corridor. Four different elevators, namely, a shuttle elevator, shown by EV.3, serves the basement floors and the first floor; two elevators, shown by EV.5 and EV.6, serve 30 floors from 1F to 30F; and the emergency elevator (EV.2) serves the entire building. The access to the roof is through the stairway which serves the entire building as well.

The total building volume is 48860.78 m³. The car parking floors (B5F-B3F) are not heated. The temperature of the commercial zones is 18°C. The lobby and the apartments are assumed to be at a constant temperature of 22°C. The stairway and shafts temperatures are uniform at 18°C. The mean outside temperature during the winter period in Seoul is assumed -11.9°C.

Multizone Infiltration Model-- Simulation Procedure

Multizone Infiltration Model

In the presented study the simulations have been carried out using the multizone model COMIS. This code allows solving the non-linear system of equations representing the airflow distribution in multizone buildings (Fundamentals, 1990). In COMIS, the building is modeled as a system of interconnected zones, each at a constant

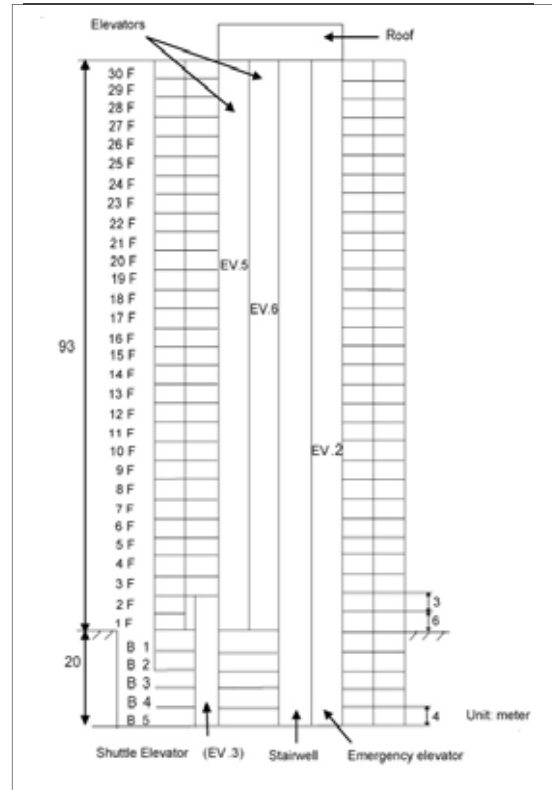

Figure 1: Layout of the Building Model.

temperature and contaminant concentration. Some relevant parameters such as airflow paths between zones and outdoor weather must be specified in the input file. Multizone buildings can be either single-room structure, single family houses or large building complexes. The COMIS model has been extensively validated by Roulet et al. (1996) and uses experimental data by Bossaer et al. (1999).

Simulation Procedure

As it has been mentioned in the introduction the main target of this paper is to model the airflow pattern and stack pressure in high-rise buildings by means of COMIS. The present building which is situated in Korea contains 30 floors above the ground level and 5 basement floors (B5F+30F+Roof). Using COMIS, the simulation has been performed using the entire building. However, the simulation failed due to the huge number of zones and interactions between them, since the COMIS model presents some limitations with regards to some parameters such as the number of zones and links, the number of pollutants, the number of wind pressure points, the number of façade elements, and so on. Therefore, a building model containing a total of 14 floors including 5 floors in the basement (B5F+14F+Roof) has been considered. This model has been decided with a maximum of zones and links with regards to the number of zones and links that can allow carrying the simulation using COMIS.

A simplified model (B5F+14F+Roof-simplified) based on the decided one has been constructed and compared with B5F+14F+Roof. The simplified model focuses on reducing the number of floors by gathering a certain number of stories into one in order to enable

the simulation to be carried out with a minimum number of zones and links. The simplified procedure has been extended to the high rise building model with 30 stories above the ground level and 5 stories in the basement.

The simulation of the simplified model with 30 stories has been carried out considering three levels of air-tightness of the exterior wall of the building. The amount of the leakage was uniformly distributed over the entire exterior wall. The leakage of each wall was assumed to be concentrated at two heights: half of the leakage occurs at 0.25 of the wall height above the floor level and the other half at 0.75 of the wall height above the floor. During the simulation all the doors were assumed to be closed. The cracks of all the doors were concentrated at the bottom and the top of each door. The equivalent areas are assumed as 0.036 m², 0.2 m², 0.015 m² and 0.02 m² for the main entrances (lobby side and commercial zone side) in the first floor, elevator door, door between the machine room in the roof and outside and other doors, respectively. Three levels of air-tightness of the exterior wall have been considered: 0.5 cm²/m² (tight), 1 cm²/m² (average), and 2 cm²/m² (loose).

Results of the Simulation

The airflow patterns through the elevator shafts are shown in Figures 2 and 3 for the considered model with 14 floors and simplified model based on considered one, respectively. There is a general upward movement of air inside the building, with air flowing into vertical shafts from the lower floors and out to the upper ones. This general pattern causes a variation in the heating and humidification load from floor to

floor, and therefore has implications for the maintenance of uniform temperatures and humidities through the building. It is also a factor in the spread of odors and other contaminants.

The airflow rates between the combined volumes in the merged model are very similar to the sum of the corresponding flow rates in the original one (14 floors). The relative deviations between the corresponding flow rates are less than 5%. It can be concluded that the simplified model could well represent the original one. Therefore, such procedure may be extended to the high-rise building with the accuracy still being satisfactory. The airflow patterns through the elevator shafts for the average exterior wall air-tightness of the B5F+30F+Roof simplified model are shown in Figure 4.

Figure 5 shows the airflow patterns at 1st, 2nd, 16th and 30th floors respectively. These figures illustrate the patterns of the air both by infiltration and exfiltration. It can be seen that from the first floor to the fifteenth floor the air enters the apartments through their exterior wall and reach the core space, while, from the fifteenth floor the air escapes from the core space to the exterior through the apartments' walls. Therefore, it can be seen that the neutral pressure plane is situated around the mid-height (16th floor) of the building.

Three levels of exterior wall air-tightness of the building have been considered: 0.5 cm²/m² (tight), 1 cm²/m² (average) and 2 cm²/m² (loose). Figures 6 and 7 show the airflow patterns through the elevator shafts with tight and loose exterior wall air-tightness, respectively. It is obvious that the total air by infiltration/exfiltration increases for the loose configuration. Moreover, a huge amount of airflow penetrates the shuttle and

emergency elevator shafts from the basements. Therefore, very tight doors should be set in these zones to avoid such huge infiltration.

The total air change rate increases with the increases of the leakage of the exterior walls of the building as shown in Figure 8. Nevertheless, 2.0 cm²/m² can be considered as a very low air-tightness level but the total air infiltration increases by 123 % compared to the tight configuration. Therefore, the level of the air-tightness of the exterior wall of the building affects strongly the total air change either by infiltration or exfiltration and then consequently the indoor air quality and the heating and cooling loads are also affected.

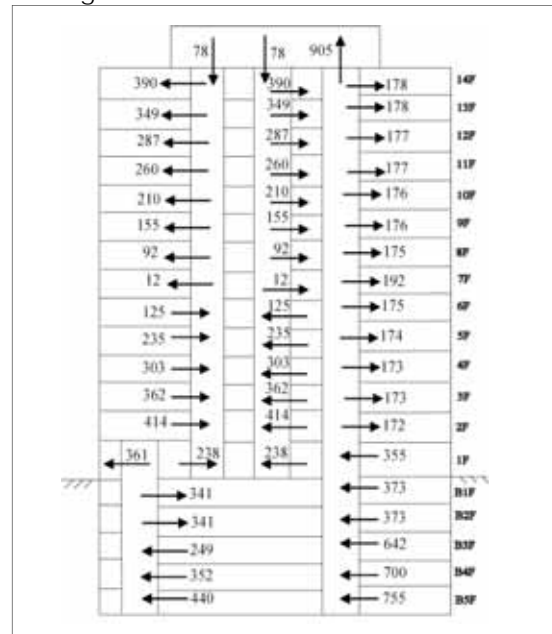

Figure 2: Airflow Patterns and Amounts [m³/h] through the Elevator Shafts for the B5F+14F+Roof Model with Average Exterior Wall Air-Tightness.

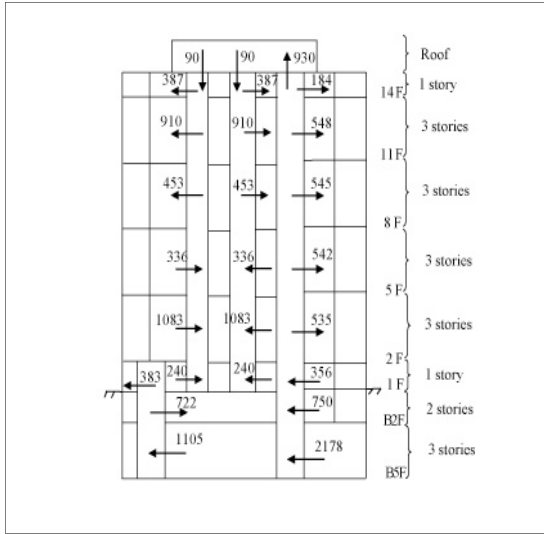

Figure 3: Airflow Patterns and Amounts [m³/h] through the Elevator Shafts for the B5F+14F+Roof Simplified Model with Average Exterior Wall Air-Tightness.

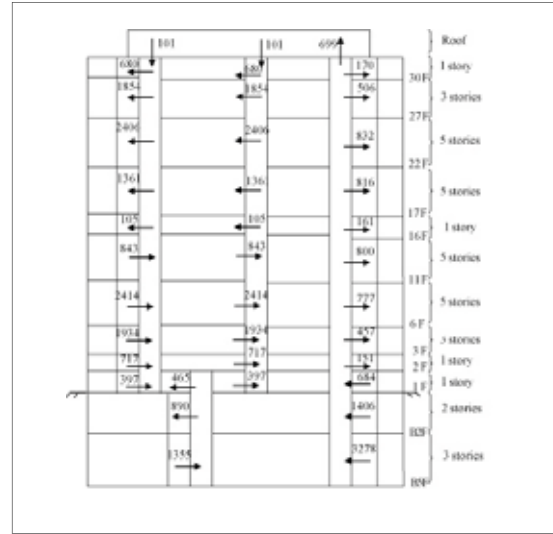

Figure 4: Airflow Patterns and Amounts [m³/h] through the Elevator Shafts for the B5F+30F+Roof Simplified Model with Average Exterior Wall Air-Tightness.

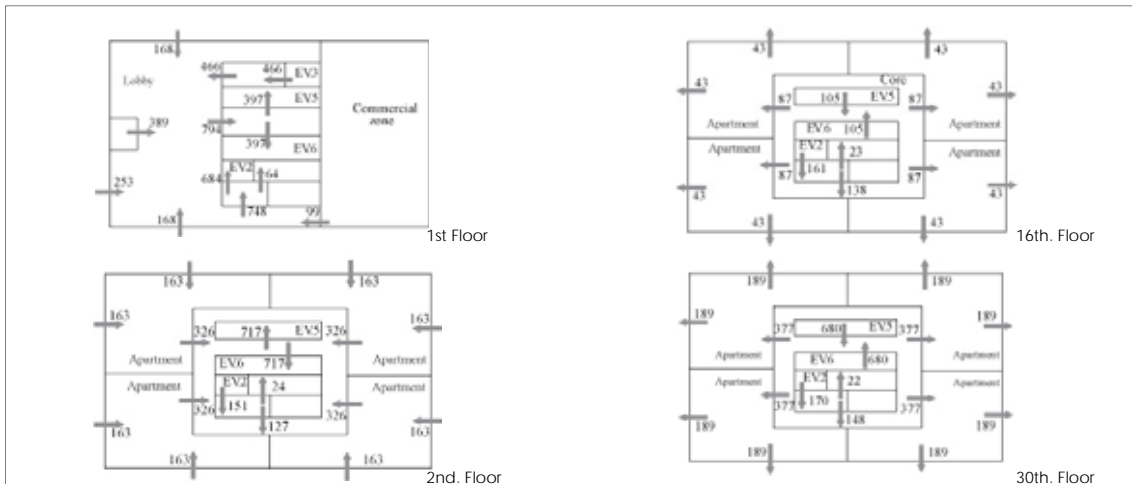

Figure 5: Airflow Patterns at Different Floor Levels

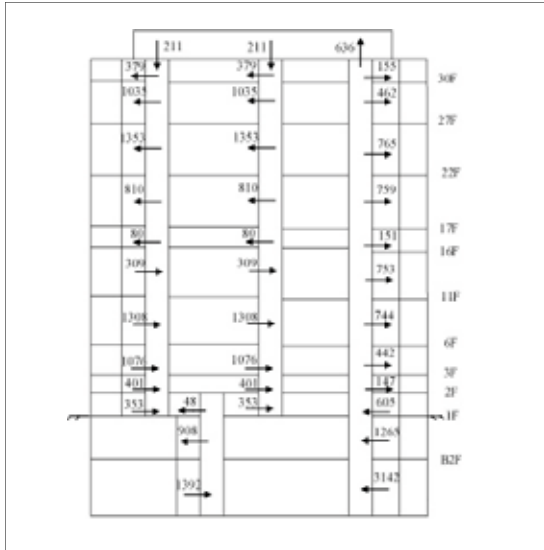

Figure 6: Airflow Patterns and Amounts [m^3/h] through the Elevator Shafts for the B5F+30F+Roof Simplified Model with Tight Exterior Wall Air-Tightness.

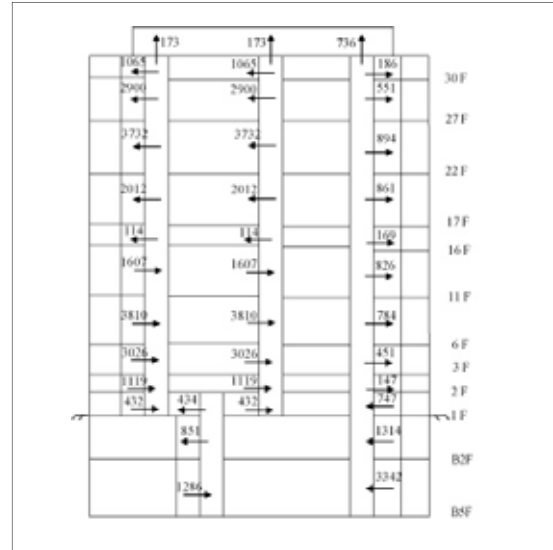

Figure 7: Airflow Patterns and Amounts [m^3/h] through the Elevator Shafts for the B5F+30F+Roof Simplified Model with Loose Exterior Wall Air-Tightness.

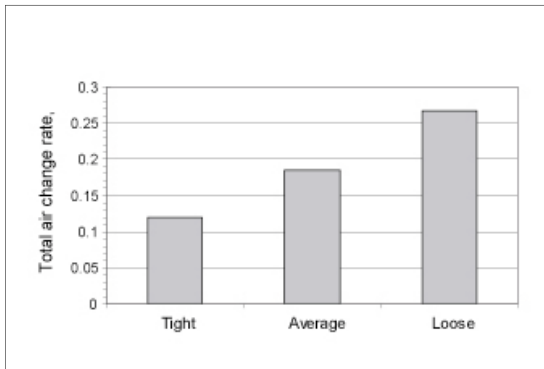

Figure 8: Total Air Change Rate vs. Exterior Wall Tightness.

Conclusion

Numerical modeling and simulation with regard to the airflow patterns of high-rise building situated in Korea by mean of COMIS software during the winter period has been carried out. The effect of exterior wall air-tightness on the stack pressure in the elevator shafts has been investigated. The conclusions of this study are as follows:

- A simplified model based on the original one which consists on gathering few stories into one has been constructed shows that the simplified model could more accurately represent the original one.

- There is a general upward movement of air inside the building under outside cold conditions with air flowing into vertical shafts from the lower floors and out to the upper ones.
- The total air by infiltration and/or exfiltration within the elevator shafts increases with the decrease of the level of the air-tightness of the exterior wall of the building.
- As soon as there is substantial leakage, through the exterior walls, the infiltration air flow "shortcuts" the stack and therefore decreases the pressure difference between indoor and outdoor.
- The required air total change cannot be provided by only infiltration even for poor level of air-tightness of the exterior walls. Therefore, mechanical ventilation is required to compensate for the lack of it.
- It has been shown that a huge amount of air infiltrates through the shuttle and emergency elevators from the basement, particularly from B5F to B3F. This causes the pressures increase in the neighboring zones of these shafts.

References

- Bossaer, A., Ducarme, D., Wouters, P., & Vandaele, L. (1999). An Example of Model Evaluation by Experimental Comparison: Pollutants Spread in an Apartment, *Energy and Buildings*, Vol. 30, pp. 53-59.
- Fundamentals of the Multizone Air Flow Model-COMIS (1990). Technical Note AIVC 29.
- Hyung Yu, K., Park, J.C., Rhee, E.K. (2004). A Study on a Proper Reduction Process of Indoor Air Pollutant in Newly-Constructed High-rise Multi-Family Houses, CTBUH, October 10-13, Seoul, Korea.
- Khoukhi, M., Yoshino, H., Liu, J. (2007). The Effect of the Wind Speed Velocity on the Stack Pressure in Medium-rise Buildings in Cold Region of China, *Building and Environment*, Vol. 42, pp. 1081-1088.
- Koo, S.H., Jo, J.H., Seo, H.S., Yeo, M.S., & Kim, K.W. (2004). Influence of Architectural Elements on Stack Effect Problems in Tall Residential Buildings, CTBUH, October 10-13, Seoul, Korea.
- Lovatt, E.J. & Wilson, A.G. (1994). Stack Effect in Tall Buildings, *ASHREE Transactions*, Vol. 100 (2), pp. 420-431.
- Roulet, C.A., Furbringer, J.M., & Borchiellini, R. (1996). Evaluation of the Multizone Air flow Simulation Code COMIS, Roomvent'96, 5th Conference on Air Distribution Rooms, Seoul, Korea.
- Tamblyn, R.T. (1991). Coping with Air Pressure Problems in Tall Buildings, *ASHREE Transactions*, Vol. 97, (1), pp. 824-827.
- Tamblyn, R.T. (1993). HVAC System Effects for Tall Buildings, *ASHREE Transactions*, Vol. 99 (2), pp. 789-92.
- Tamura, G.T., & Wilson, A.G., (1967). Pressure Differences Caused by Chimney Effect in Three High Buildings, *ASHREE Transactions*, Vol. 73 (2), pp. 1-10.
- Yu, J.Y., Cho, D.W., Yu, K.H., & Jung, H.K. (2004). Evaluation of Stack Effect According to the Shape and the Window Area Ratios of Lobby in High-rise Buildings, CTBUH, October 10-13, Seoul, Korea.

Acknowledgements

The author acknowledges King Fahd University of Petroleum and Minerals-KFUPM for providing support to finalize this paper.